

(Units : mm)

• VQFP144

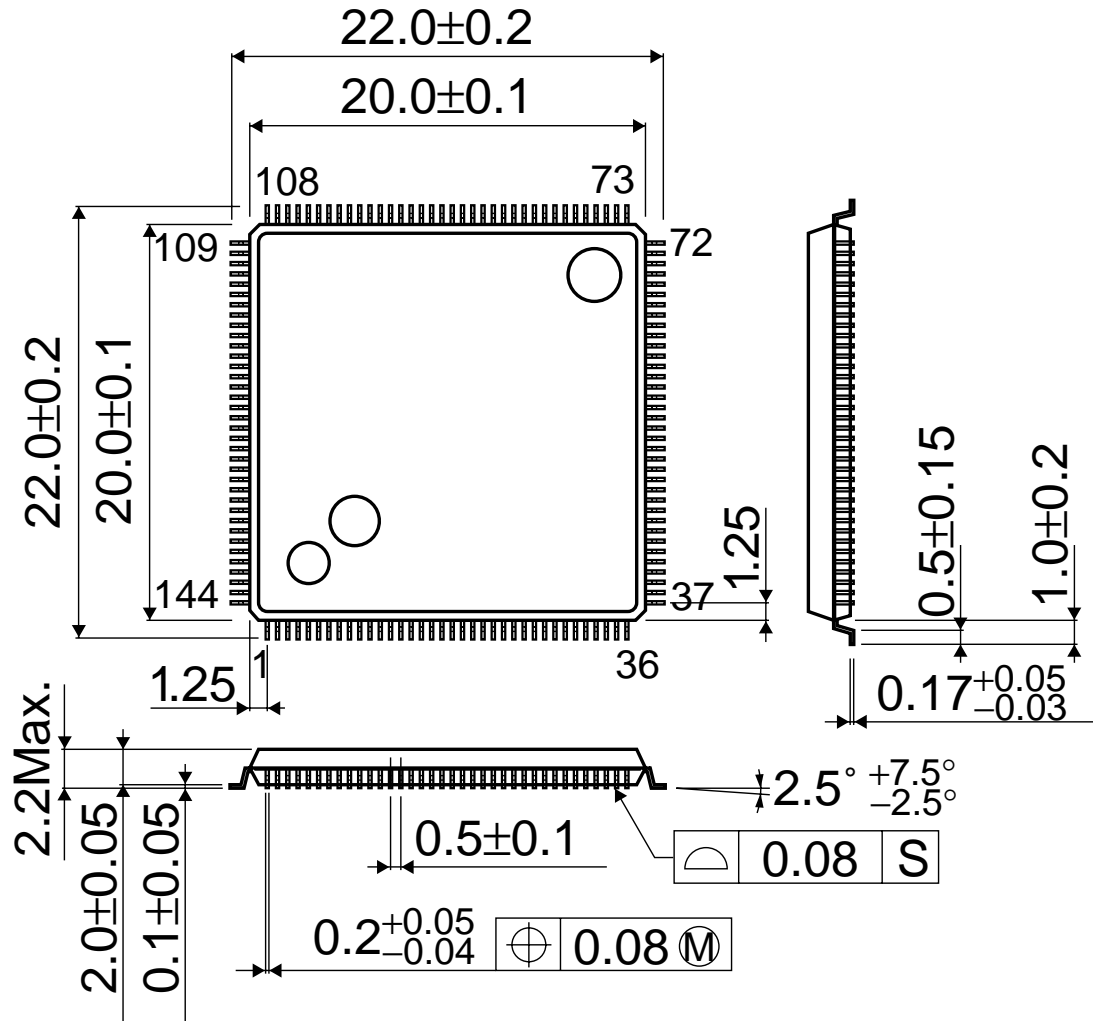

* The contents described herein are subject to change without notice.