

SN75LBC976 9-CHANNEL DIFFERENTIAL TRANSCIEVER

SLLS133D – AUGUST 1992 – REVISED MAY 1995

- **Nine Differential Channels for the Data and Control Paths of the Differential Small Computer Systems Interface (SCSI) and Intelligent Peripheral Interface (IPI-2)**
- **Meets or Exceeds the Requirements of ANSI Standard RS-485 and ISO 8482:1987(E)**
- **Packaged in Shrink Small-Outline Package With 25-mil Terminal Pitch**
- **Designed to Operate at 10 Million Transfers Per Second**
- **Low Disabled Supply Current
1.4 mA Typical**
- **Thermal-Shutdown Protection**
- **Power-Up/Power-Down Glitch Protection**
- **Positive and Negative Output-Current Limiting**
- **Open-Circuit Fail-Safe Receiver Design**

description

The SN75LBC976 is a nine-channel differential transceiver based on the 75LBC176 LinASIC™ cell. Use of TI's LinBiCMOS™† process technology allows the power reduction necessary to integrate nine differential transceivers. On-chip enabling logic makes this device applicable for the data path (eight data bits plus parity) and the control path (nine bits) for both the Small Computer Systems Interface (SCSI) and the Intelligent Peripheral Interface (IPI-2) standard data interfaces.

The SN75LBC976 is packaged in a shrink small-outline package (DL) with improved thermal characteristics using heat-sink terminals. This package is ideal for low-profile, space-restricted applications such as hard disk drives.

The switching speed and testing capabilities of the SN75LBC976 are sufficient to transfer data over the data bus at 10 million transfers per second. Each of the nine channels conforms to the requirements of the ANSI RS-485 and ISO 8482:1987(E) standards referenced by ANSI X3.129-1986 (IPI), ANSI X3.131-1993 (SCSI-2), and the proposed SCSI-3 standards.

The SN75LBC976 is characterized for operation from 0°C to 70°C.

**DL PACKAGE
(TOP VIEW)**

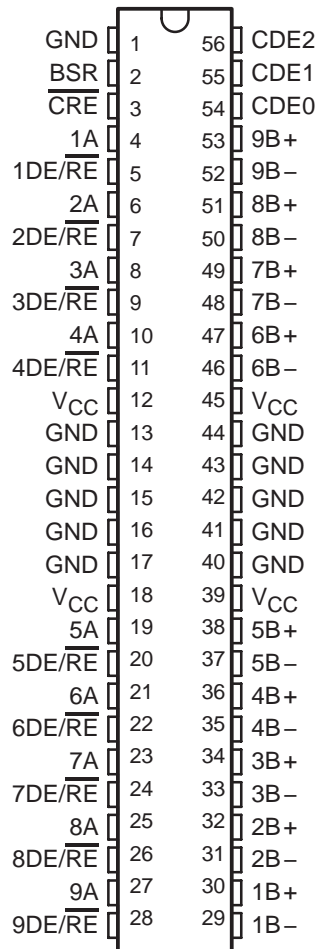

Pins 13 through 17 and 40 through 44 are connected together to the package lead frame and signal ground.

† Patent pending

LinASIC and LinBiCMOS are trademarks of Texas Instruments Incorporated.

PRODUCTION DATA information is current as of publication date. Products conform to specifications per the terms of Texas Instruments standard warranty. Production processing does not necessarily include testing of all parameters.



SN75LBC976 9-CHANNEL DIFFERENTIAL TRANSCIEVER

SLLS133D – AUGUST 1992 – REVISED MAY 1995

logic diagram (positive logic)†

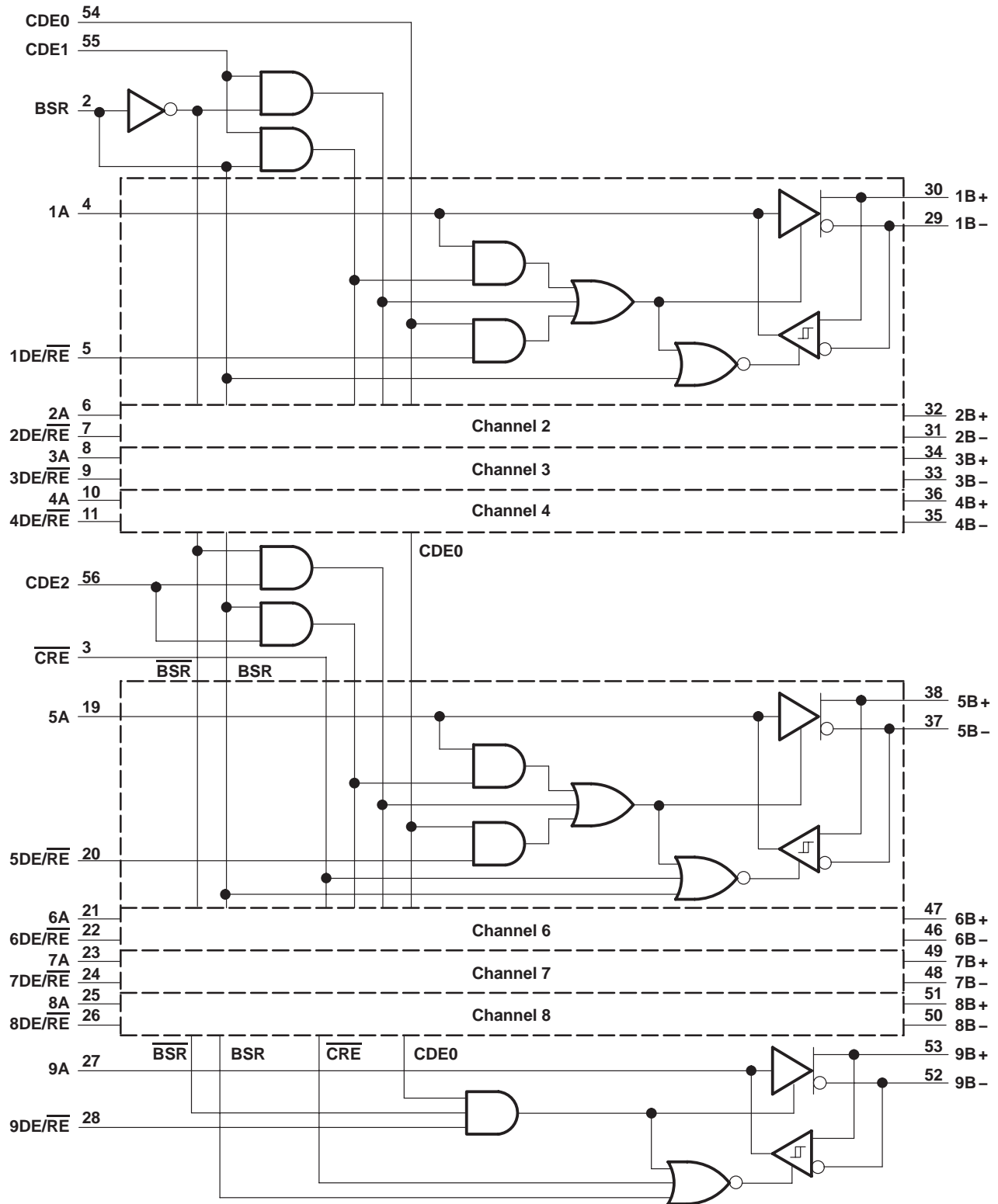

† For additional logic diagrams, see Application Information, Table 1 and Figures 7 through 44.



schematics of inputs and outputs

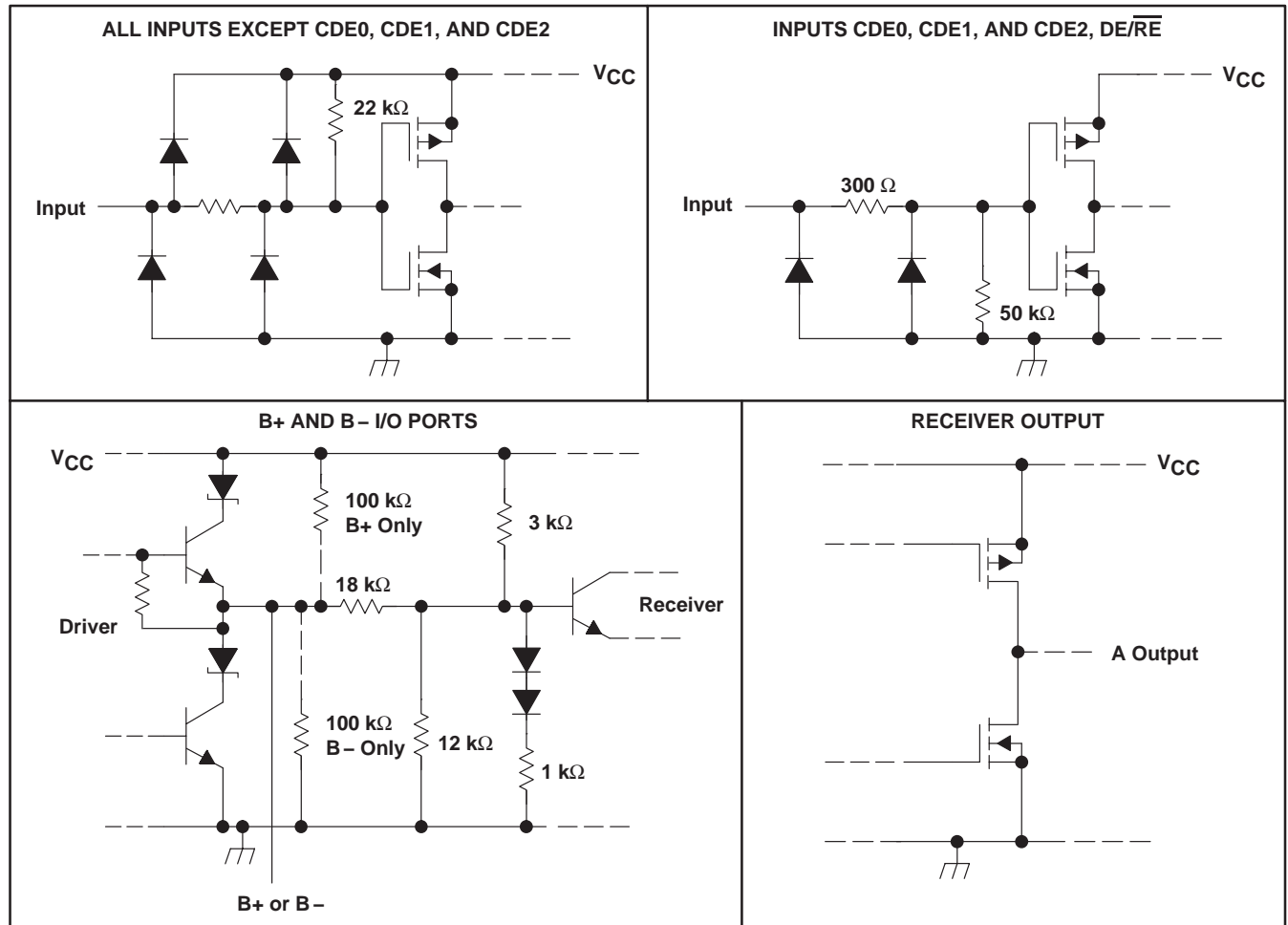

absolute maximum ratings over operating free-air temperature range (unless otherwise noted)†

Supply voltage range, V_{CC} (see Note 1)	–0.3 V to 7 V
Bus voltage range	–10 V to 15 V
Data I/O and control (A-side) voltage range	–0.3 V to 7 V
Continuous power dissipation	internally limited
Operating free-air temperature range, T_A	0°C to 70°C
Storage temperature range, T_{stg}	–65°C to 150°C
Lead temperature 1,6 mm (1/16 inch) from case for 10 seconds	260°C

† Stresses beyond those listed under “absolute maximum ratings” may cause permanent damage to the device. These are stress ratings only, and functional operation of the device at these or any other conditions beyond those indicated under “recommended operating conditions” is not implied. Exposure to absolute-maximum-rated conditions for extended periods may affect device reliability.

NOTE 1: All voltage values are with respect to GND.

SN75LBC976

9-CHANNEL DIFFERENTIAL TRANSCIEVER

SLLS133D – AUGUST 1992 – REVISED MAY 1995

recommended operating conditions

		MIN	NOM	MAX	UNIT
Supply voltage, V_{CC}		4.75	5	5.25	V
Voltage at any bus terminal (separately or common-mode), V_O , V_I , or V_{IC}	B+ or B-	12			V
		-7			
High-level input voltage, V_{IH}	All except B+ and B-	2			V
Low-level input voltage, V_{IL}	All except B+ and B-	0.8			V
High-level output current, I_{OH}	B+ or B-	-60			mA
	A	-8			mA
Low-level output current, I_{OL}	B+ or B-	60			mA
	A	8			mA
Operating free-air temperature, T_A		0	70		°C

device electrical characteristics over recommended ranges of operating conditions (unless otherwise noted)

PARAMETER		TEST CONDITIONS		MIN	TYP†	MAX	UNIT
I_{IH} High-level input current	BSR, A, $\overline{DE/RE}$, and \overline{CRE}	See Figure 1	$V_{IH} = 2\text{ V}$			-200	μA
	CDE0, CDE1, and CDE2					100	μA
I_{IL} Low-level input current	BSR, A, $\overline{DE/RE}$, and \overline{CRE}		$V_{IL} = 0.8\text{ V}$			-200	μA
	CDE0, CDE1, and CDE2					100	μA
I_{CC} Supply current	All drivers and receivers disabled	BSR and CDE0 at 5 V, Other inputs at 0 V			1.4	3	mA
	All receivers enabled	No load, $V_{ID} = 5\text{ V}$, All other inputs at 0 V			29	45	mA
	All drivers enabled	BSR at 0 V, No load, All other inputs at 5 V			4.8	10	mA
C_O Bus port output capacitance		B+ or B-			16		pF
C_{pd} Power dissipation capacitance‡		One driver			460		pF
		One receiver			50		pF

† All typical values are at $V_{CC} = 5\text{ V}$, $T_A = 25^\circ\text{C}$.

‡ C_{pd} determines the no-load dynamic current consumption; $I_S = C_{pd} \cdot V_{CC} \cdot f + I_{CC}$.

driver electrical characteristics over recommended ranges of operating conditions (unless otherwise noted)

PARAMETER		TEST CONDITIONS		MIN	TYP	MAX	UNIT
$ V_{OD} $ Differential output voltage		$V_{\text{test}} = -7\text{ V to }12\text{ V}$,	See Figure 2	1	2		V
I_{OS} Output short-circuit current		See Figure 3				± 250	mA
I_{OZ} High-impedance-state output current		See receiver input current					

SN75LBC976

9-CHANNEL DIFFERENTIAL TRANSCEIVER

SLLS133D – AUGUST 1992 – REVISED MAY 1995

receiver electrical characteristics over recommended ranges of operating conditions (unless otherwise noted)

PARAMETER		TEST CONDITIONS	MIN	TYP†	MAX	UNIT	
V_{OH}	High-level output voltage	$V_{ID} = 200\text{ mV}$, See Figure 1		2.5		V	
V_{OL}	Low-level output voltage	$V_{ID} = -200\text{ mV}$, See Figure 1			0.8	V	
V_{IT+}	Positive-going input threshold voltage	$I_{OH} = -8\text{ mA}$, See Figure 1			0.2	V	
V_{IT-}	Negative-going input threshold voltage	$I_{OL} = 8\text{ mA}$, See Figure 1	-0.2			V	
V_{hys}	Receiver input hysteresis voltage ($V_{IT+} - V_{IT-}$)			45		mV	
I_I	Receiver input current	B+ and B-	$V_I = 12\text{ V}$, Other input at 0 V,	$V_{CC} = 5\text{ V}$, See Figure 1	0.7	1	mA
			$V_I = 12\text{ V}$, Other input at 0 V,	$V_{CC} = 0$, See Figure 1	0.8	1	mA
			$V_I = -7\text{ V}$, Other input at 0 V,	$V_{CC} = 5\text{ V}$, See Figure 1	-0.5	-0.8	mA
			$V_I = -7\text{ V}$, Other input at 0 V,	$V_{CC} = 0$, See Figure 1	-0.4	-0.8	mA
I_{OZ}	High-impedance-state output current	See Figure 1	$V_O = \text{GND}$		-200	μA	
			$V_O = V_{CC}$		50		

driver switching characteristics over recommended operating conditions (unless otherwise noted) (see Figure 4)

PARAMETER		TEST CONDITIONS	MIN	TYP†	MAX	UNIT
$t_{d(OD)}$	Differential delay time, high- to low-level output ($t_{d(ODH)}$) or low- to high-level output ($t_{d(ODL)}$)		7.6		19.6	ns
		$V_{CC} = 5\text{ V}$, $T_A = 25^\circ\text{C}$	9.1		17.1	
		$V_{CC} = 5\text{ V}$, $T_A = 70^\circ\text{C}$	11.5		19.5	
$t_{sk(lim)}$	Skew limit, the maximum difference in propagation delay times between any two drivers on any two devices				12	ns
		$V_{CC} = 5\text{ V}$, See Note 2			8	
$t_{sk(p)}$	Pulse skew ($ t_{d(ODL)} - t_{d(ODH)} $)			0	6	ns
t_t	Transition time (t_r or t_f)			10		ns

† All typical values are at $V_{CC} = 5\text{ V}$, $T_A = 25^\circ\text{C}$.

NOTE 2: This specification applies to any 5°C band within the operating temperature range.



SN75LBC976

9-CHANNEL DIFFERENTIAL TRANSCIVER

SLLS133D – AUGUST 1992 – REVISED MAY 1995

receiver switching characteristics over recommended operating conditions (see Figure 5) (unless otherwise noted)

PARAMETER		TEST CONDITIONS	MIN	TYP†	MAX	UNIT
t_{pd}	Propagation delay time, high- to low-level output (t_{PLH}) or low- to high-level output (t_{PHL})		21.5		33	ns
		$V_{CC} = 5\text{ V}, T_A = 25^\circ\text{C}$	22.6		31.6	
		$V_{CC} = 5\text{ V}, T_A = 70^\circ\text{C}$	23.4		32.4	
$t_{sk(lim)}$	Skew limit, the maximum difference in propagation delay times between any two drivers on any two devices				12	ns
		$V_{CC} = 5\text{ V},$ See Note 2			9	
$t_{sk(p)}$	Pulse skew ($ t_{PHL} - t_{PLH} $)			2	6	ns
t_t	Transition time (t_r or t_f)			3		ns

† All typical values are at $V_{CC} = 5\text{ V}, T_A = 25^\circ\text{C}$.

NOTE 2: This specification applies to any 5°C band within the operating temperature range.

transceiver switching characteristics over recommended operating conditions

PARAMETER		TEST CONDITIONS	MIN	MAX	UNIT
$t_{en(RXL)}$	Enable time, transmit-to-receive to low-level output	See Figure 6		150	ns
$t_{en(RXH)}$	Enable time, transmit-to-receive to high-level output			150	ns
$t_{en(TXL)}$	Enable time, receive-to-transmit to low-level output			80	ns
$t_{en(TXH)}$	Enable time, receive-to-transmit to high-level output			80	ns
t_{su}	Setup time, CDE0, CDE1, CDE2, BSR, or $\overline{\text{CRE}}$ to active input(s) or output(s)			150	ns

thermal characteristics

PARAMETER		TEST CONDITIONS	MIN	TYP	MAX	UNIT
$R_{\theta JA}$	Junction-to-free-air thermal resistance	Board mounted, No air flow		50		$^\circ\text{C}/\text{W}$
$R_{\theta JC}$	Junction-to-case thermal resistance			12		$^\circ\text{C}/\text{W}$

PARAMETER MEASUREMENT INFORMATION

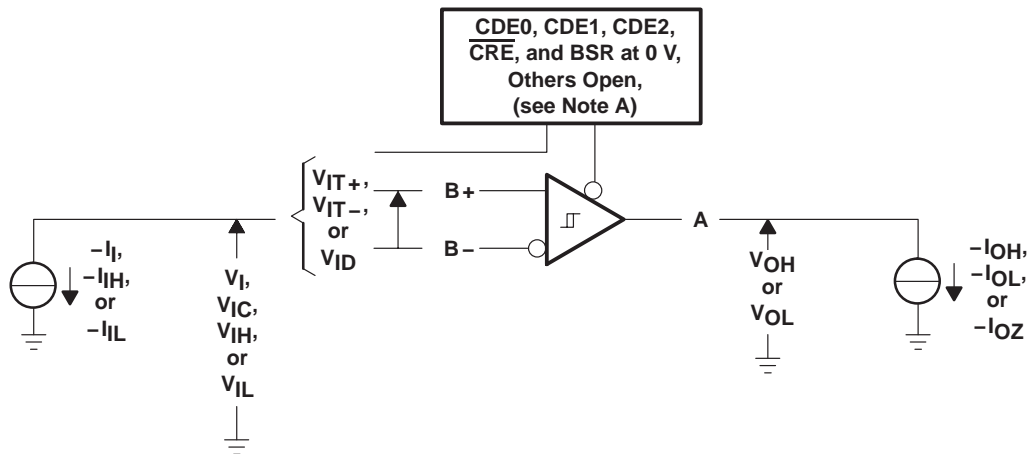

NOTE A: For the I_{OZ} measurement, BSR is at 5 V and CDE0, CDE1, and CDE2 are at 0 V.

Figure 1. Receiver Test Circuit and Input Conditions

PARAMETER MEASUREMENT INFORMATION

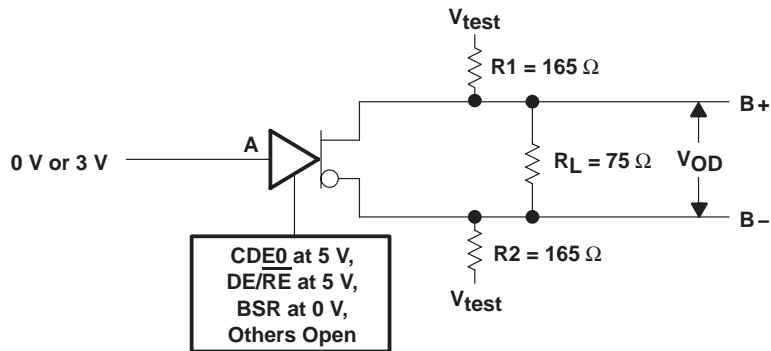
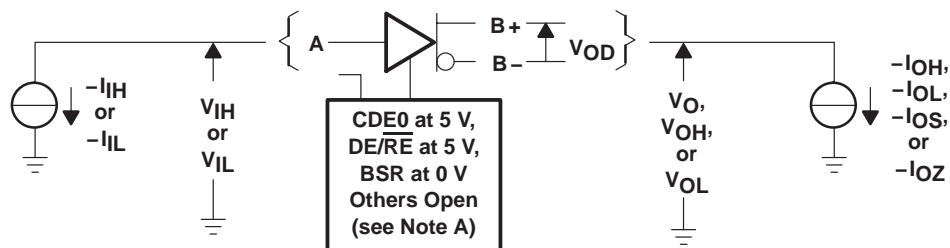

Figure 2. Driver V_{OD} Test Circuit



NOTE A: For the I_{OZ} test, the BSR input is at 5 V and all others are at 0 V.

Figure 3. Driver Test Circuit and Input Conditions

SN75LBC976 9-CHANNEL DIFFERENTIAL TRANSCIEVER

SLLS133D – AUGUST 1992 – REVISED MAY 1995

PARAMETER MEASUREMENT INFORMATION

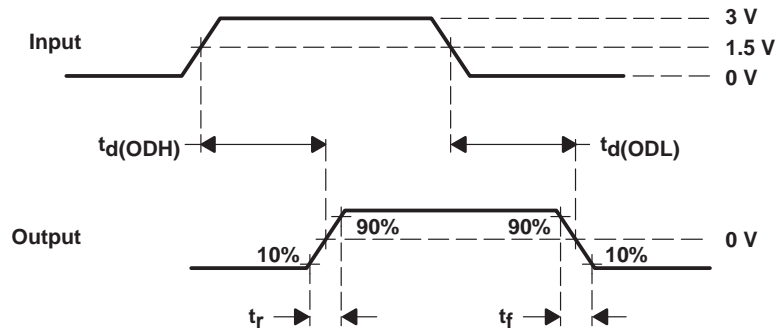
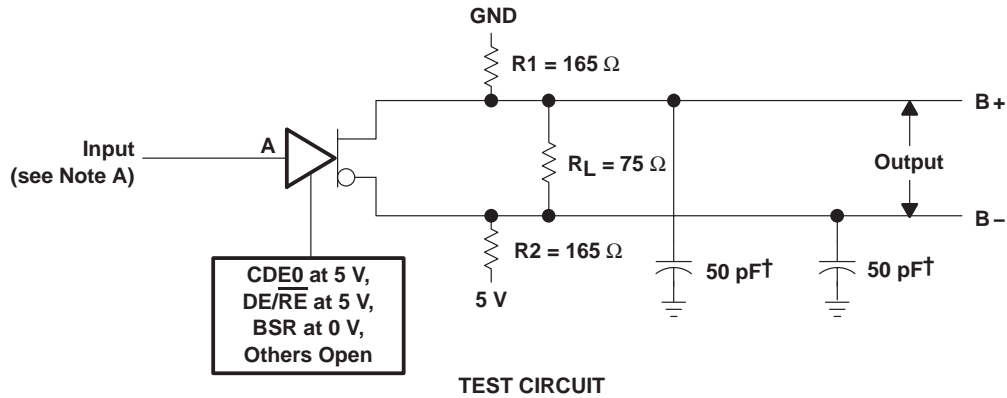

† Includes probe and jig capacitance.

NOTE A: The input is provided by a pulse generator with an output of 0 to 3 V, PRR of 1 MHz, 50% duty cycle, t_r and $t_f < 6$ ns, and $Z_O = 50 \Omega$.

Figure 4. Driver Test Circuit and Voltage Waveforms

PARAMETER MEASUREMENT INFORMATION

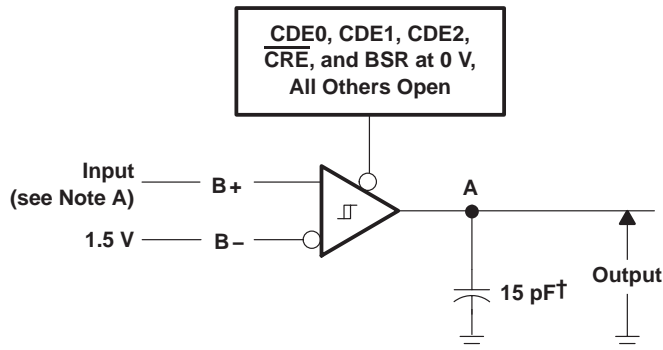

TEST CIRCUIT

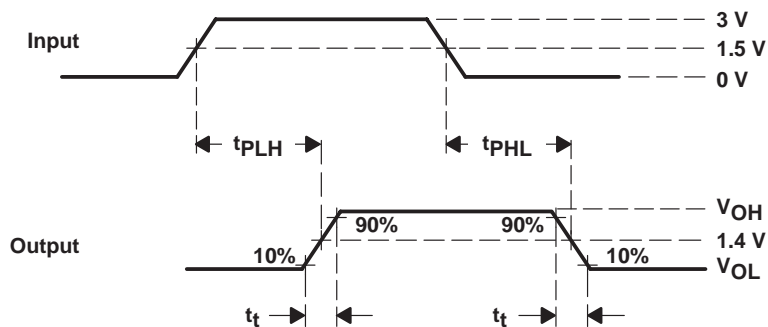

VOLTAGE WAVEFORMS

† Includes probe and jig capacitance.

NOTE A: The input is provided by a pulse generator with an output of 0 to 3 V, PRR of 1 MHz, 50% duty cycle, t_r and $t_f < 6$ ns, and $Z_O = 50 \Omega$.

Figure 5. Receiver Test Circuit and Voltage Waveforms

SN75LBC976 9-CHANNEL DIFFERENTIAL TRANSCIEVER

SLLS133D – AUGUST 1992 – REVISED MAY 1995

PARAMETER MEASUREMENT INFORMATION

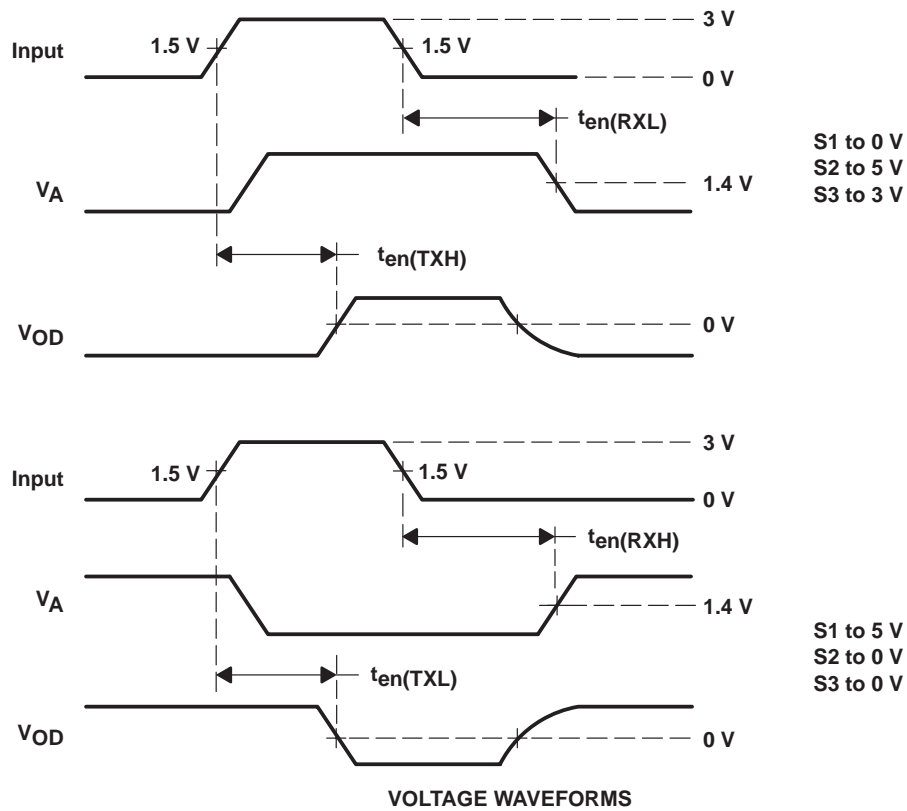
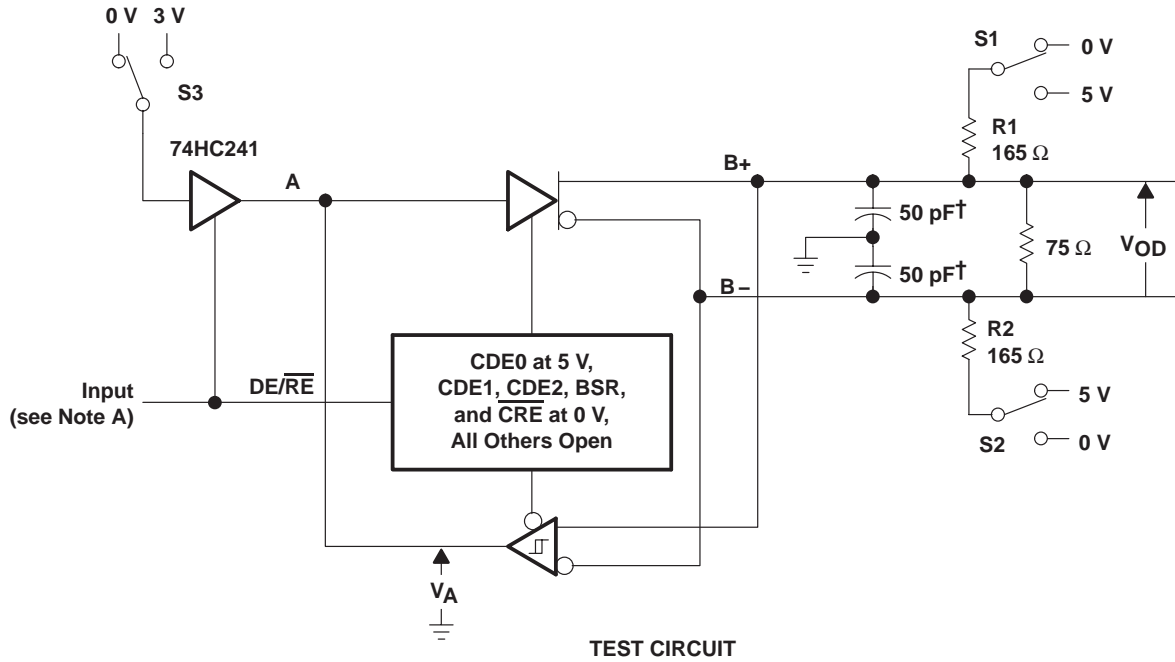

† Includes probe and jig capacitance.

NOTE A: The input is provided by a pulse generator with an output of 0 to 3 V, PRR of 1 MHz, 50% duty cycle, t_r and $t_f < 6$ ns, and $Z_O = 50 \Omega$.

Figure 6. Enable Time Test Circuit and Voltage Waveforms

TYPICAL CHARACTERISTICS

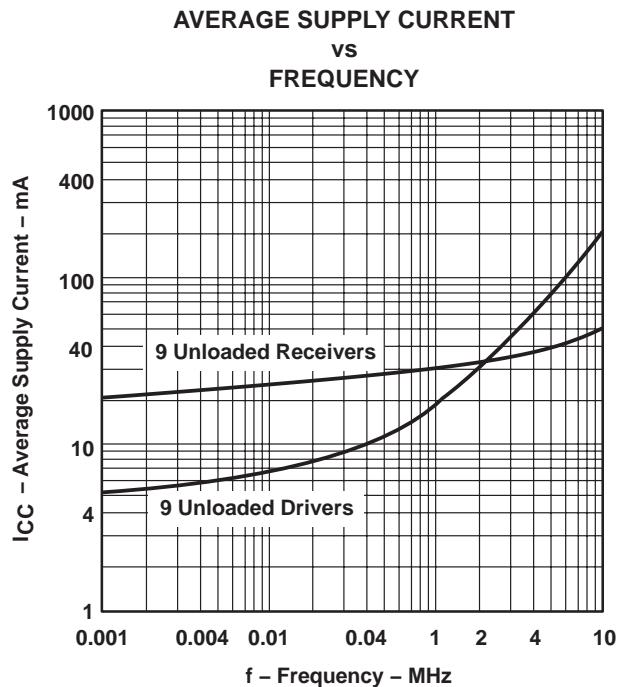

Figure 7

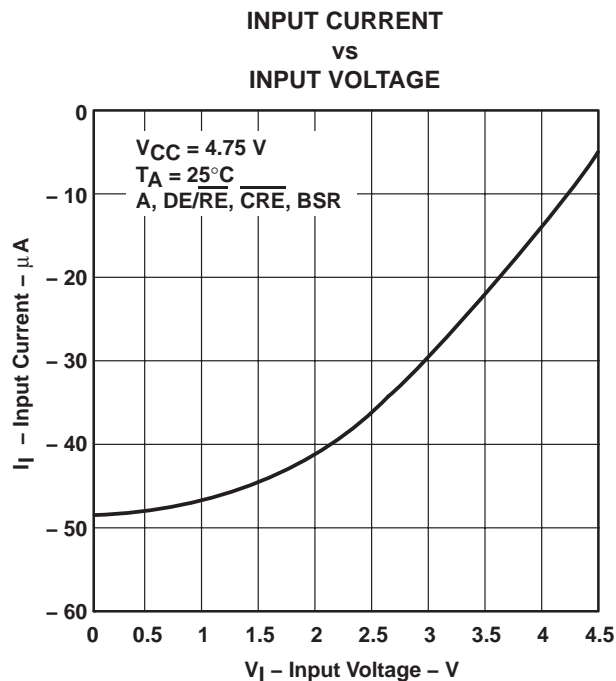

Figure 8

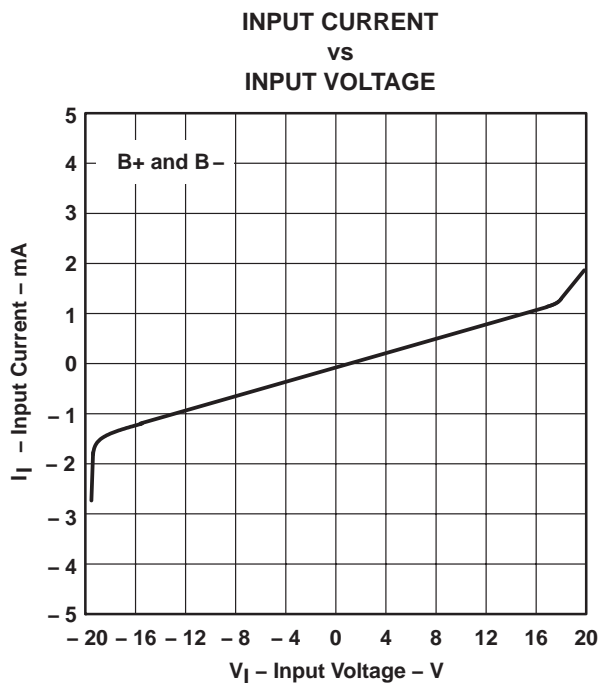
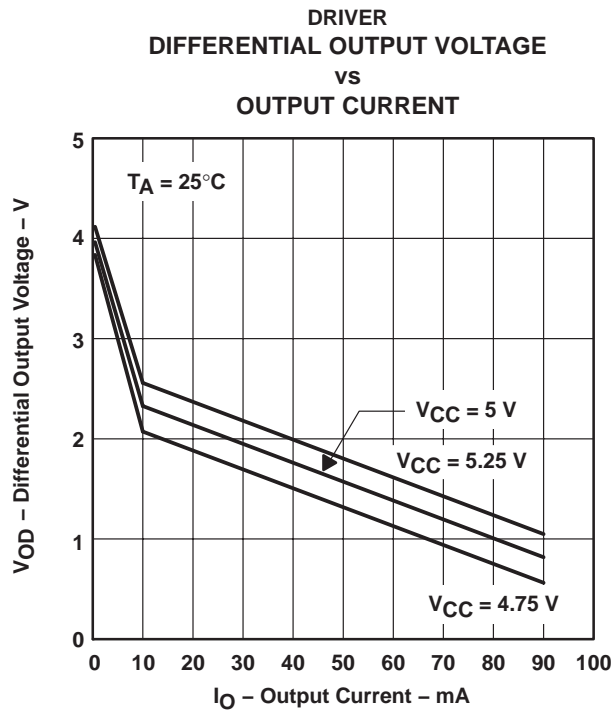
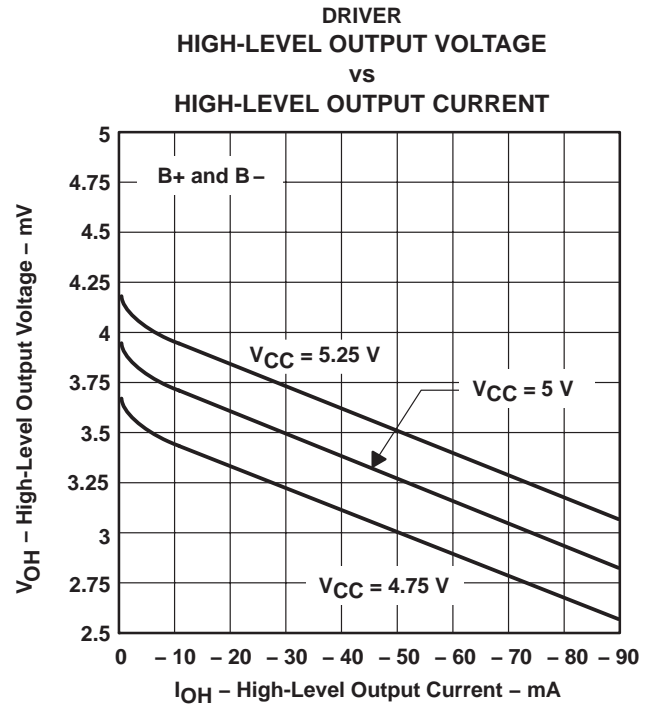
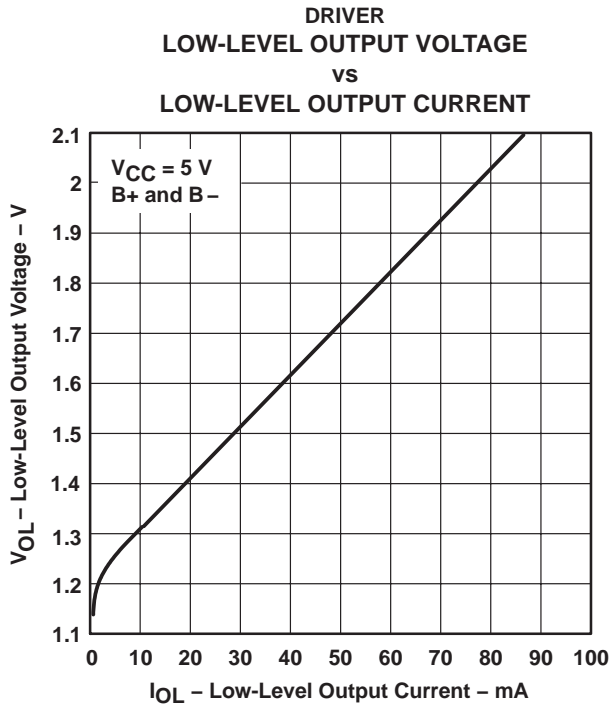

Figure 9

SN75LBC976 9-CHANNEL DIFFERENTIAL TRANSCEIVER

SLLS133D – AUGUST 1992 – REVISED MAY 1995

TYPICAL CHARACTERISTICS



TYPICAL CHARACTERISTICS

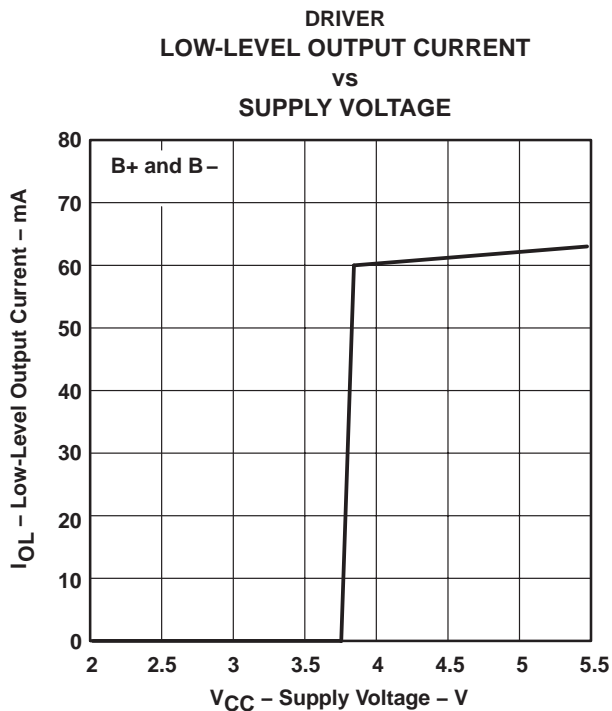

Figure 13

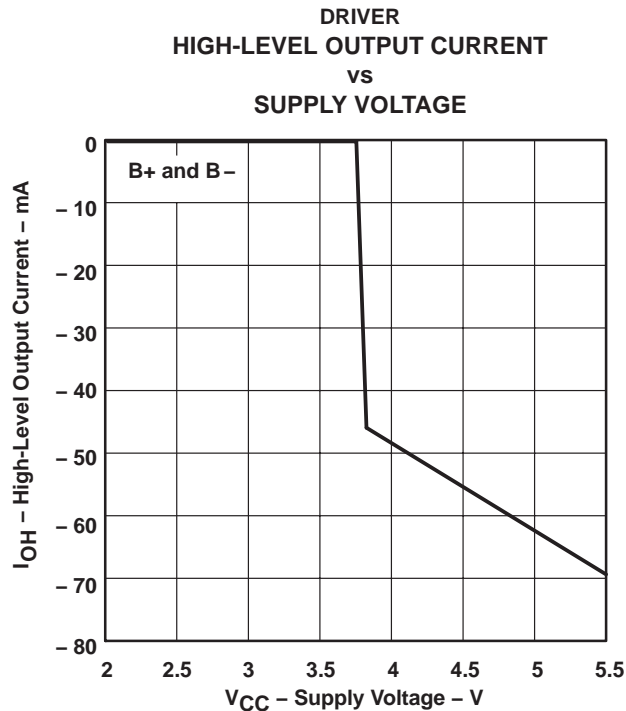

Figure 14

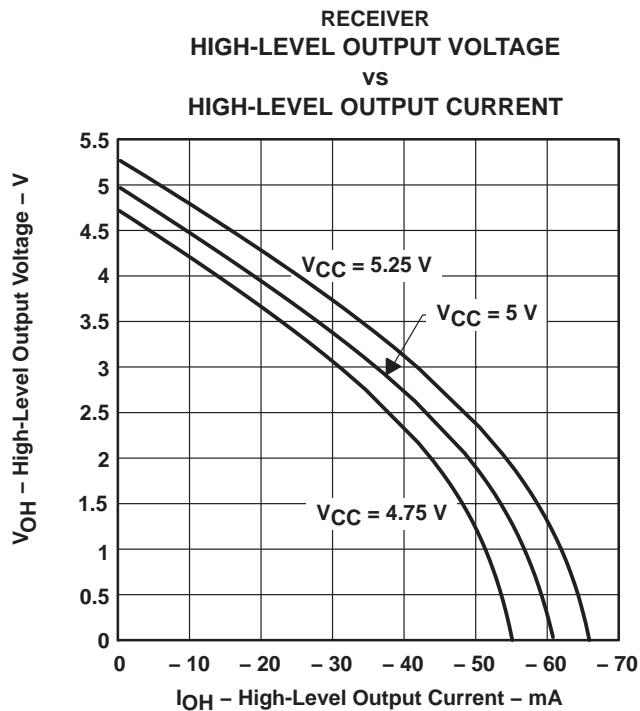

Figure 15

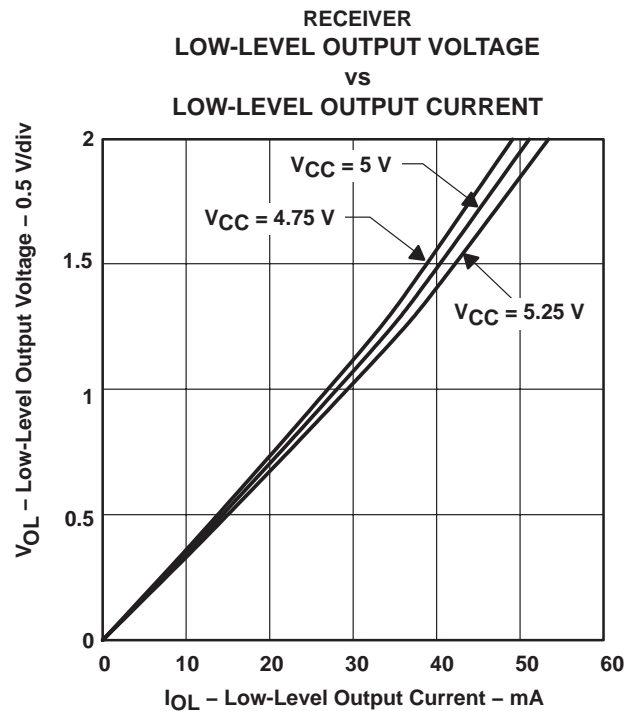
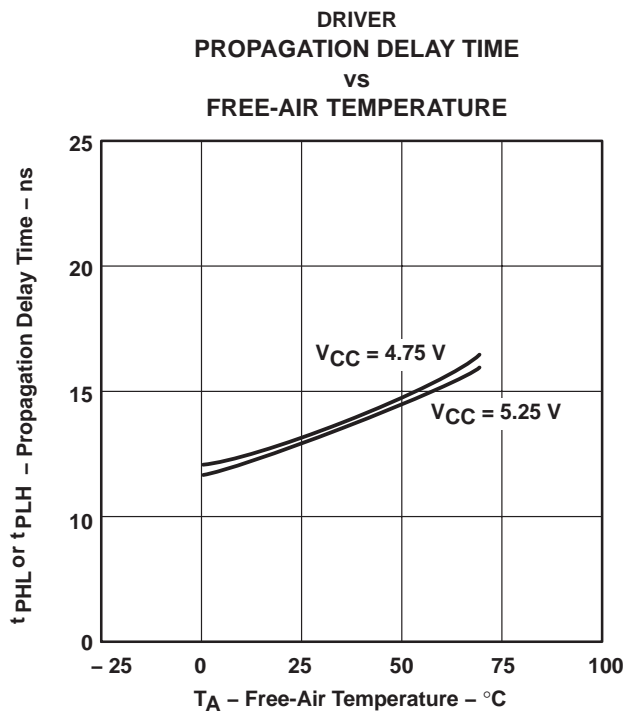
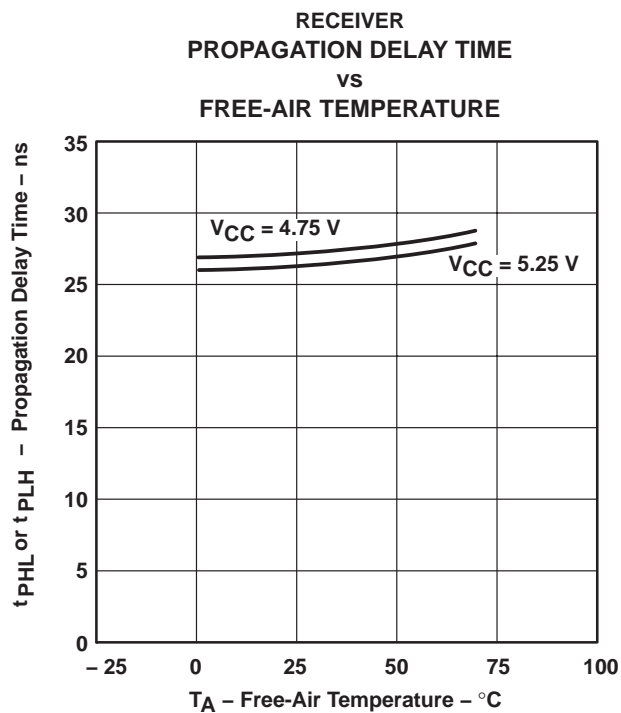
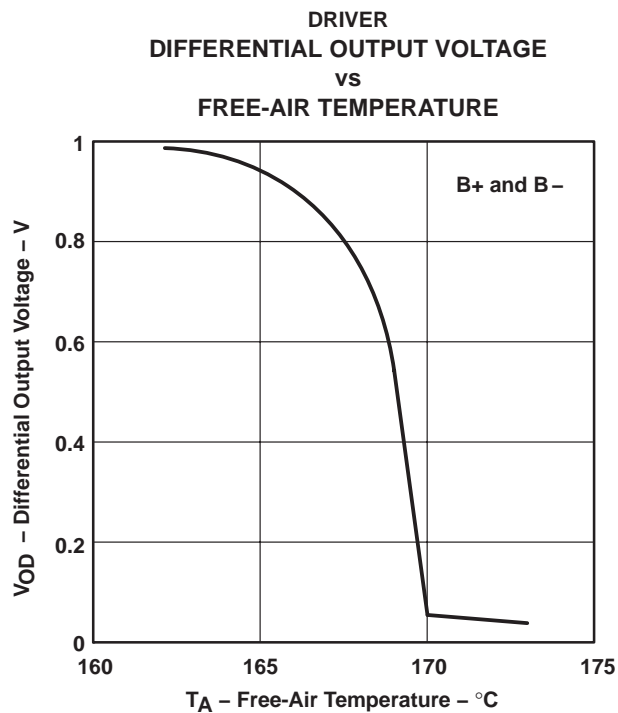

Figure 16

SN75LBC976 9-CHANNEL DIFFERENTIAL TRANSCEIVER

SLLS133D – AUGUST 1992 – REVISED MAY 1995

TYPICAL CHARACTERISTICS



APPLICATION INFORMATION

Table 1. Typical Signal and Terminal Assignments

SIGNAL	TERMINAL	SCSI DATA	SCSI CONTROL	IPI DATA	IPI CONTROL
CDE0	54	DIFFSENSE	DIFFSENSE	V _{CC}	V _{CC}
CDE1	55	GND	GND	XMTA, XMTB	GND
CDE2	56	GND	GND	XMTA, XMTB	SLAVE/MASTER
BSR	2	GND	GND	GND, BSR	GND
$\overline{\text{CRE}}$	3	GND	GND	GND	V _{CC}
1A	4	DB0, DB8	ATN	AD7, BD7	NOT USED
1DE/ $\overline{\text{RE}}$	5	DBE0, DBE8	INIT EN	GND	GND
2A	6	DB1, DB9	BSY	AD6, BD6	NOT USED
2DE/ $\overline{\text{RE}}$	7	DBE1, DBE9	BSY EN	GND	GND
3A	8	DB2, DB10	ACK	AD5, BD5	SYNC IN
3DE/ $\overline{\text{RE}}$	9	DBE2, DBE10	INIT EN	GND	GND
4A	10	DB3, DB11	RST	AD4, BD4	SLAVE IN
4DE/ $\overline{\text{RE}}$	11	DBE3, DBE11	GND	GND	GND
5A	19	DB4, DB12	MSG	AD3, BD3	NOT USED
5DE/ $\overline{\text{RE}}$	20	DBE4, DBE12	TARG EN	GND	GND
6A	21	DB5, DB13	SEL	AD2, BD2	SYNC OUT
6DE/ $\overline{\text{RE}}$	22	DBE5, DBE13	SEL EN	GND	GND
7A	23	DB6, DB14	C/D	AD1, BD1	MASTER OUT
7DE/ $\overline{\text{RE}}$	24	DBE6, DBE14	TARG EN	GND	GND
8A	25	DB7, DB15	REQ	AD0, BD0	SELECT OUT
8DE/ $\overline{\text{RE}}$	26	DBE7, DBE15	TARG EN	GND	GND
9A	27	DBP0, DBP1	I/O	AP, BP	ATTENTION IN
9DE/ $\overline{\text{RE}}$	28	DBPE0, DBPE1	TARG EN	XMTA, XMTB	V _{CC}

ABBREVIATIONS:

- DBn, data bit n, where n = (0,1, . . . ,15)
- DBEn, data bit n enable, where n = (0,1, . . . ,15)
- DBP0, parity bit for data bits 0 through 7 or IPI bus A
- DBPE0, parity bit enable for P0
- DBP1, parity bit for data bits 8 through 15 or IPI bus B
- DBPE1, parity bit enable for P1
- ADn or BDn, IPI Bus A – Bit n (ADn) or Bus B – Bit n (BDn), where n = (0,1, . . . ,7)
- AP or BP, IPI parity bit for bus A or bus B
- XMTA or XMTB, transmit enable for IPI bus A or B
- BSR, bit significant response
- INIT EN, common enable for SCSI initiator mode
- TARG EN, common enable for SCSI target mode

NOTE: Signal inputs are shown as active high. If only active-low inputs are available, logic inversion is accomplished by reversing the B+ and B– connector terminal assignments.



SN75LBC976 9-CHANNEL DIFFERENTIAL TRANSCIEVER

SLLS133D – AUGUST 1992 – REVISED MAY 1995

APPLICATION INFORMATION

Function Tables

RECEIVER



INPUTS		OUTPUT
B+†	B-†	A
L	H	L
H	L	H

DRIVER



INPUT A	OUTPUTS	
	B+	B-
L	L	H
H	H	L

TRANSCIEVER

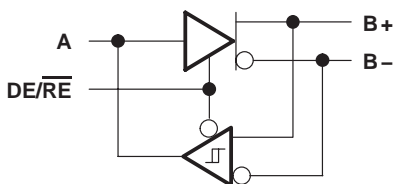

DE/RE	INPUTS			OUTPUTS		
	A	B+†	B-†	A	B+	B-
L	-	L	H	L	-	-
L	-	H	L	H	-	-
H	L	-	-	-	L	H
H	H	-	-	-	H	L

DRIVER WITH ENABLE

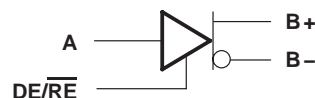

DE/RE	INPUTS		OUTPUTS	
	A		B+	B-
L	L		Z	Z
L	H		Z	Z
H	L		L	H
H	H		H	L

WIRED-OR DRIVER

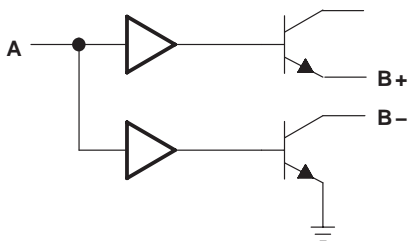

INPUT A	OUTPUTS	
	B+	B-
L	Z	Z
H	H	L

TWO-ENABLE INPUT DRIVER

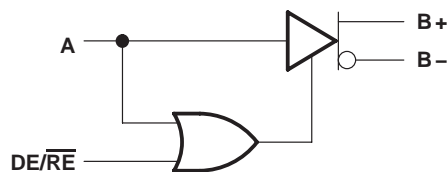

DE/RE	INPUTS		OUTPUTS	
	A		B+	B-
L	L		Z	Z
L	H		H	L
H	L		L	H
H	H		H	L

H = high level, L = low level, X = irrelevant, Z = high impedance (off)

† An H in this column represents a voltage 200 mV higher than the other bus input. An L represents a voltage 200 mV lower than the other bus input. Any voltage less than 200 mV results in an indeterminate receiver output.

APPLICATION INFORMATION

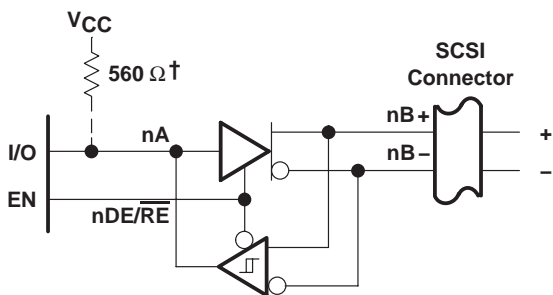

(a) ACTIVE-HIGH BIDIRECTIONAL I/O WITH SEPARATE ENABLE

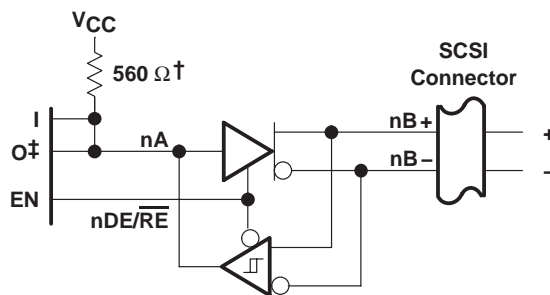

(d) SEPARATE ACTIVE-HIGH INPUT, OUTPUT, AND ENABLE

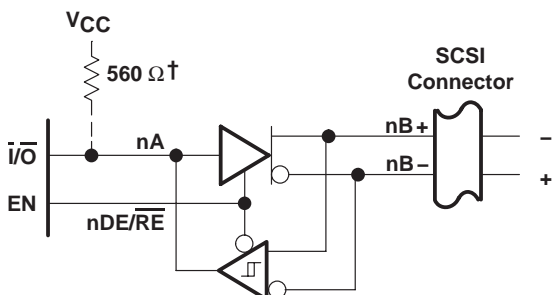

(b) ACTIVE-LOW BIDIRECTIONAL I/O WITH SEPARATE ENABLE

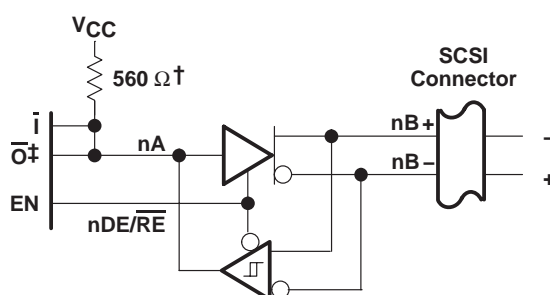

(e) SEPARATE ACTIVE-LOW INPUT AND OUTPUT AND ACTIVE-HIGH ENABLE

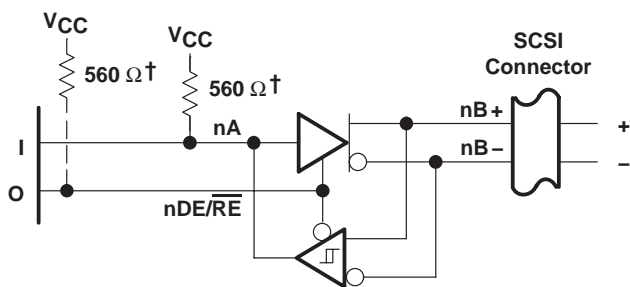

(c) WIRED-OR DRIVER AND ACTIVE-HIGH INPUT

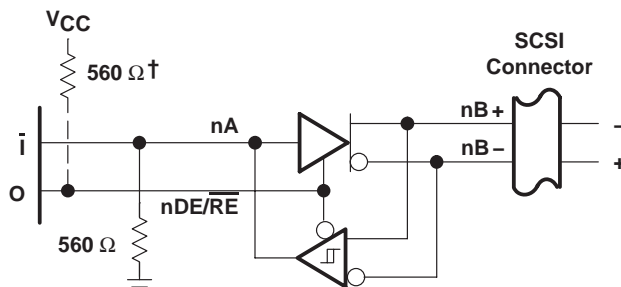

(f) WIRED-OR DRIVER AND ACTIVE-LOW INPUT

† If 0, is open drain

‡ Must be open-drain or 3-state output

NOTE: The BSR, CRE, A, and DE/RE inputs have internal pullups. CDE0, CDE1, and CDE2 have internal pulldowns.

Figure 20. Typical SCSI Transceiver Connections

SN75LBC976 9-CHANNEL DIFFERENTIAL TRANSCIEVER

SLLS133D – AUGUST 1992 – REVISED MAY 1995

APPLICATION INFORMATION

channel logic configurations with control input logic

The following logic diagrams show the positive-logic representation for all combinations of control inputs. The control inputs are from MSB to LSB; BSR, CDE0, CDE1, CDE2, and $\overline{\text{CRE}}$, and are shown below the diagrams. Channel 1 is at the top and channel 9 is at the bottom of the logic diagrams.

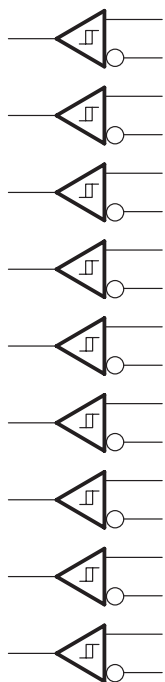

Figure 21. 00000

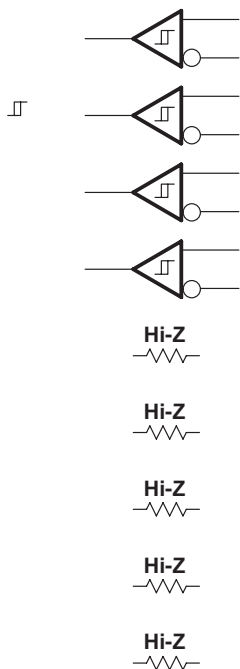

Figure 22. 00001

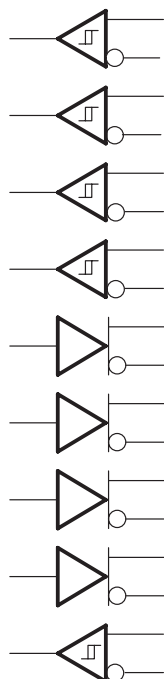

Figure 23. 00010

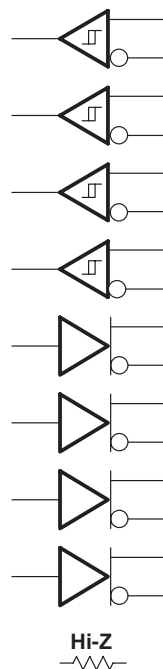

Figure 24. 00011

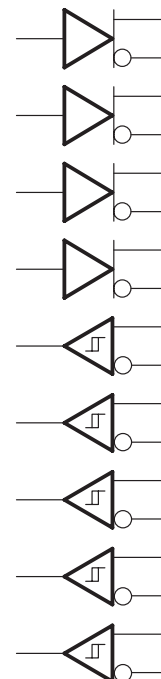

Figure 25. 00100

APPLICATION INFORMATION

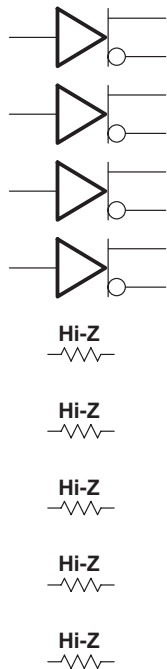

Figure 26. 00101

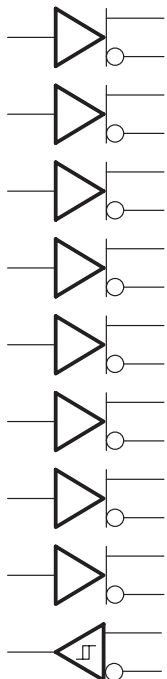

Figure 27. 00110

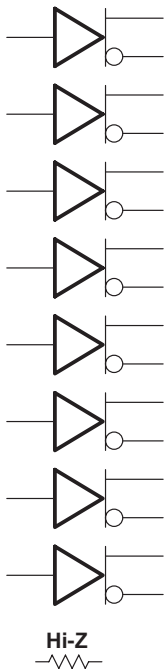

Figure 28. 00111

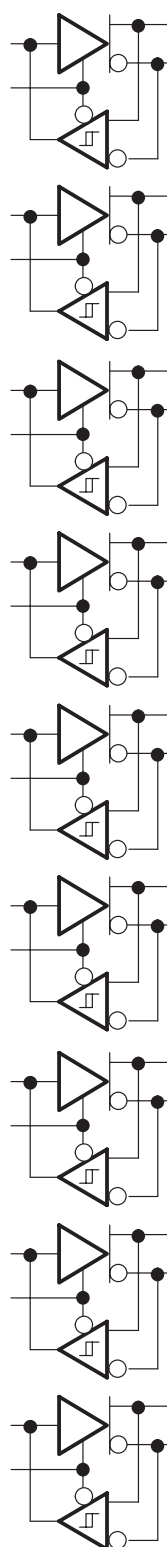

Figure 29. 01000

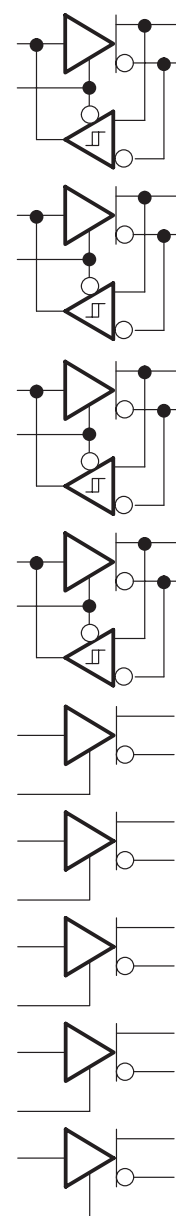

Figure 30. 01001

SN75LBC976 9-CHANNEL DIFFERENTIAL TRANSCIEVER

SLLS133D – AUGUST 1992 – REVISED MAY 1995

APPLICATION INFORMATION

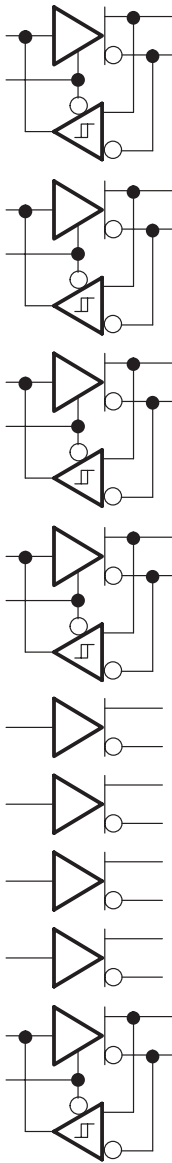

Figure 31. 01010

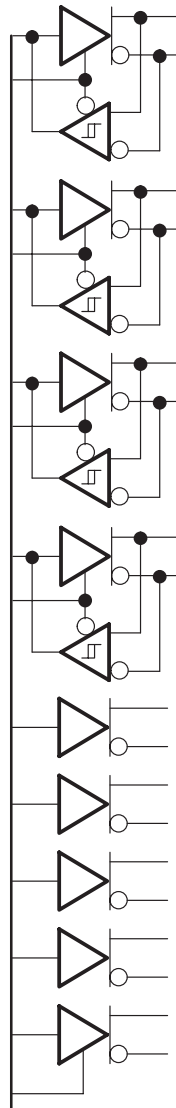

Figure 32. 01011

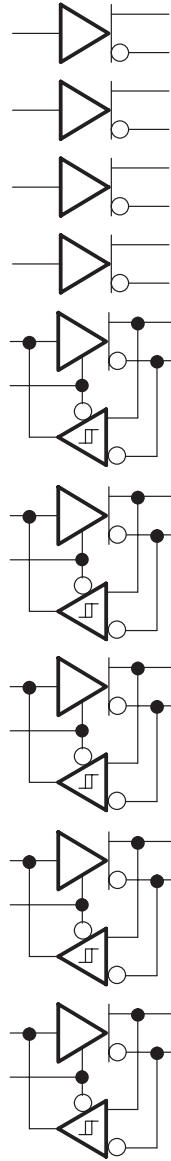

Figure 33. 01100

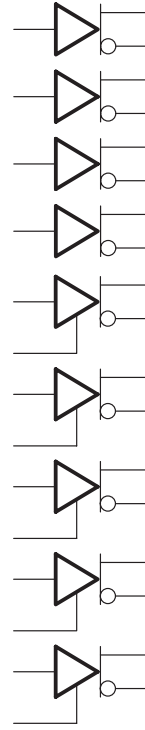

Figure 34. 01101

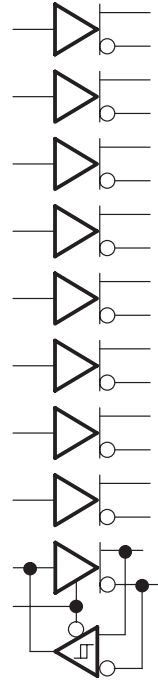

Figure 35. 01110

APPLICATION INFORMATION

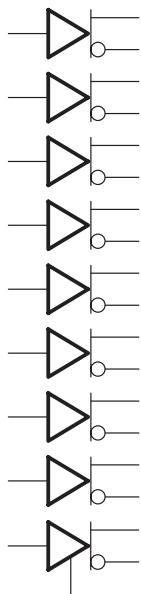

Figure 36. 01111



Figure 37.
10000
and 10001

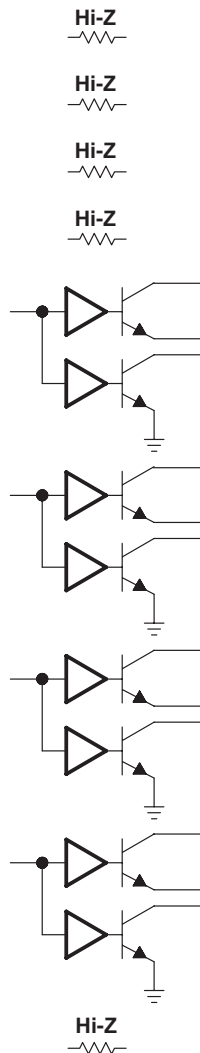

Figure 38. 10010
and 10011

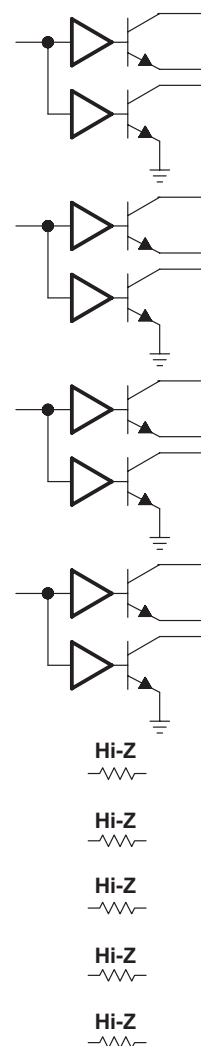

Figure 39. 10100
and 10101

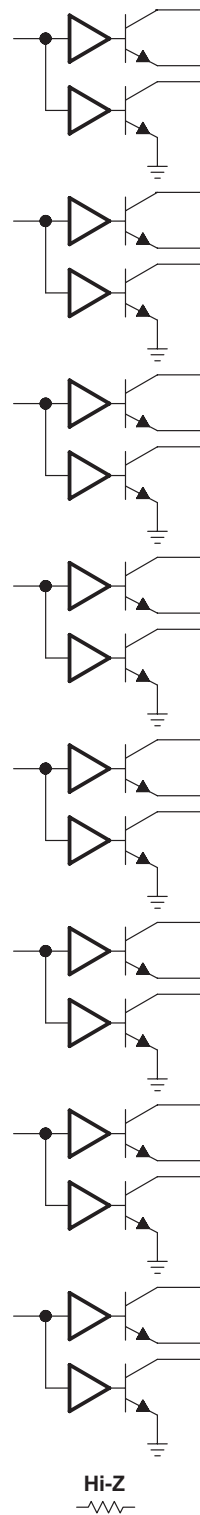

Figure 40. 10110
and 10111

SN75LBC976 9-CHANNEL DIFFERENTIAL TRANSCIEVER

SLLS133D – AUGUST 1992 – REVISED MAY 1995

APPLICATION INFORMATION

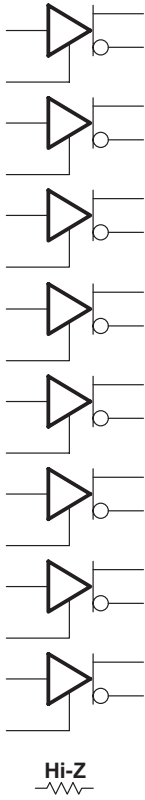

Figure 41. 11000
and 11001

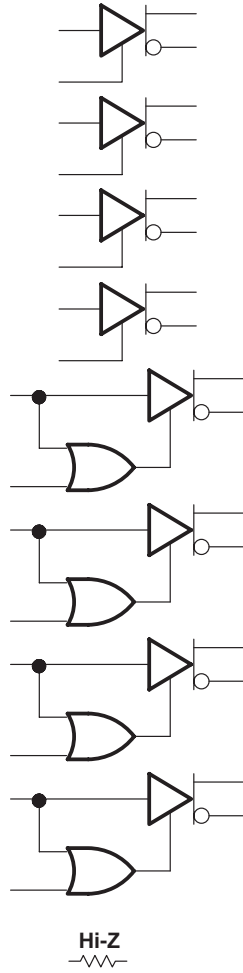

Figure 42. 11010
and 11011

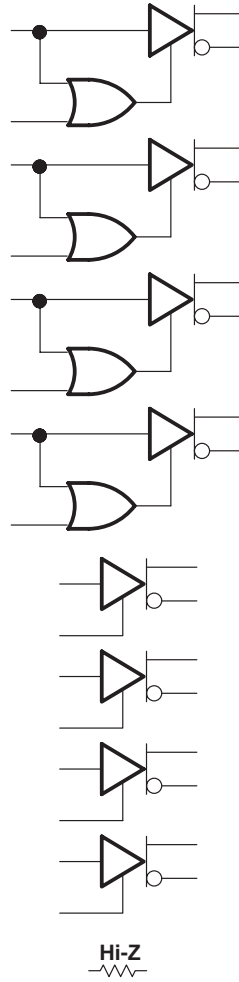

Figure 43. 11100
and 11101

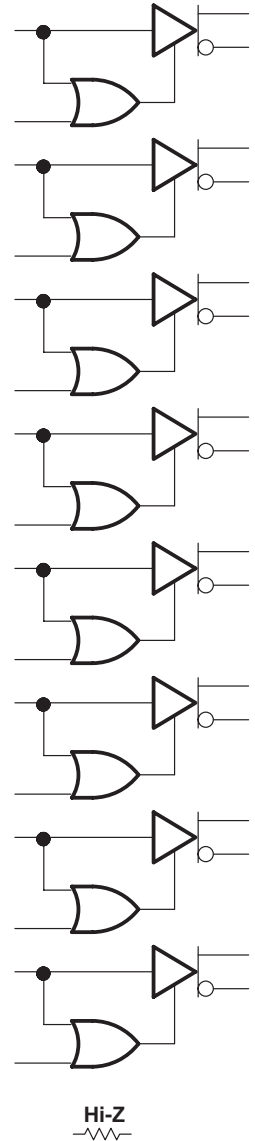

Figure 44. 11110
and 11111

PACKAGING INFORMATION

Orderable Device	Status ⁽¹⁾	Package Type	Package Drawing	Pins	Package Qty	Eco Plan ⁽²⁾	Lead/Ball Finish	MSL Peak Temp ⁽³⁾
SN75LBC976DLR	OBSOLETE	SSOP	DL	56		TBD	Call TI	Call TI

⁽¹⁾ The marketing status values are defined as follows:

ACTIVE: Product device recommended for new designs.

LIFEBUY: TI has announced that the device will be discontinued, and a lifetime-buy period is in effect.

NRND: Not recommended for new designs. Device is in production to support existing customers, but TI does not recommend using this part in a new design.

PREVIEW: Device has been announced but is not in production. Samples may or may not be available.

OBSOLETE: TI has discontinued the production of the device.

⁽²⁾ Eco Plan - The planned eco-friendly classification: Pb-Free (RoHS), Pb-Free (RoHS Exempt), or Green (RoHS & no Sb/Br) - please check <http://www.ti.com/productcontent> for the latest availability information and additional product content details.

TBD: The Pb-Free/Green conversion plan has not been defined.

Pb-Free (RoHS): TI's terms "Lead-Free" or "Pb-Free" mean semiconductor products that are compatible with the current RoHS requirements for all 6 substances, including the requirement that lead not exceed 0.1% by weight in homogeneous materials. Where designed to be soldered at high temperatures, TI Pb-Free products are suitable for use in specified lead-free processes.

Pb-Free (RoHS Exempt): This component has a RoHS exemption for either 1) lead-based flip-chip solder bumps used between the die and package, or 2) lead-based die adhesive used between the die and leadframe. The component is otherwise considered Pb-Free (RoHS compatible) as defined above.

Green (RoHS & no Sb/Br): TI defines "Green" to mean Pb-Free (RoHS compatible), and free of Bromine (Br) and Antimony (Sb) based flame retardants (Br or Sb do not exceed 0.1% by weight in homogeneous material)

⁽³⁾ MSL, Peak Temp. -- The Moisture Sensitivity Level rating according to the JEDEC industry standard classifications, and peak solder temperature.

Important Information and Disclaimer:The information provided on this page represents TI's knowledge and belief as of the date that it is provided. TI bases its knowledge and belief on information provided by third parties, and makes no representation or warranty as to the accuracy of such information. Efforts are underway to better integrate information from third parties. TI has taken and continues to take reasonable steps to provide representative and accurate information but may not have conducted destructive testing or chemical analysis on incoming materials and chemicals. TI and TI suppliers consider certain information to be proprietary, and thus CAS numbers and other limited information may not be available for release.

In no event shall TI's liability arising out of such information exceed the total purchase price of the TI part(s) at issue in this document sold by TI to Customer on an annual basis.

OTHER QUALIFIED VERSIONS OF SN75LBC976 :

- Military: [SN55LBC976](#)

NOTE: Qualified Version Definitions:

- Military - QML certified for Military and Defense Applications

IMPORTANT NOTICE

Texas Instruments Incorporated and its subsidiaries (TI) reserve the right to make corrections, modifications, enhancements, improvements, and other changes to its products and services at any time and to discontinue any product or service without notice. Customers should obtain the latest relevant information before placing orders and should verify that such information is current and complete. All products are sold subject to TI's terms and conditions of sale supplied at the time of order acknowledgment.

TI warrants performance of its hardware products to the specifications applicable at the time of sale in accordance with TI's standard warranty. Testing and other quality control techniques are used to the extent TI deems necessary to support this warranty. Except where mandated by government requirements, testing of all parameters of each product is not necessarily performed.

TI assumes no liability for applications assistance or customer product design. Customers are responsible for their products and applications using TI components. To minimize the risks associated with customer products and applications, customers should provide adequate design and operating safeguards.

TI does not warrant or represent that any license, either express or implied, is granted under any TI patent right, copyright, mask work right, or other TI intellectual property right relating to any combination, machine, or process in which TI products or services are used. Information published by TI regarding third-party products or services does not constitute a license from TI to use such products or services or a warranty or endorsement thereof. Use of such information may require a license from a third party under the patents or other intellectual property of the third party, or a license from TI under the patents or other intellectual property of TI.

Reproduction of TI information in TI data books or data sheets is permissible only if reproduction is without alteration and is accompanied by all associated warranties, conditions, limitations, and notices. Reproduction of this information with alteration is an unfair and deceptive business practice. TI is not responsible or liable for such altered documentation. Information of third parties may be subject to additional restrictions.

Resale of TI products or services with statements different from or beyond the parameters stated by TI for that product or service voids all express and any implied warranties for the associated TI product or service and is an unfair and deceptive business practice. TI is not responsible or liable for any such statements.

TI products are not authorized for use in safety-critical applications (such as life support) where a failure of the TI product would reasonably be expected to cause severe personal injury or death, unless officers of the parties have executed an agreement specifically governing such use. Buyers represent that they have all necessary expertise in the safety and regulatory ramifications of their applications, and acknowledge and agree that they are solely responsible for all legal, regulatory and safety-related requirements concerning their products and any use of TI products in such safety-critical applications, notwithstanding any applications-related information or support that may be provided by TI. Further, Buyers must fully indemnify TI and its representatives against any damages arising out of the use of TI products in such safety-critical applications.

TI products are neither designed nor intended for use in military/aerospace applications or environments unless the TI products are specifically designated by TI as military-grade or "enhanced plastic." Only products designated by TI as military-grade meet military specifications. Buyers acknowledge and agree that any such use of TI products which TI has not designated as military-grade is solely at the Buyer's risk, and that they are solely responsible for compliance with all legal and regulatory requirements in connection with such use.

TI products are neither designed nor intended for use in automotive applications or environments unless the specific TI products are designated by TI as compliant with ISO/TS 16949 requirements. Buyers acknowledge and agree that, if they use any non-designated products in automotive applications, TI will not be responsible for any failure to meet such requirements.

Following are URLs where you can obtain information on other Texas Instruments products and application solutions:

Products

Amplifiers	amplifier.ti.com
Data Converters	dataconverter.ti.com
DSP	dsp.ti.com
Clocks and Timers	www.ti.com/clocks
Interface	interface.ti.com
Logic	logic.ti.com
Power Mgmt	power.ti.com
Microcontrollers	microcontroller.ti.com
RFID	www.ti-rfid.com
RF/IF and ZigBee® Solutions	www.ti.com/lprf

Applications

Audio	www.ti.com/audio
Automotive	www.ti.com/automotive
Broadband	www.ti.com/broadband
Digital Control	www.ti.com/digitalcontrol
Medical	www.ti.com/medical
Military	www.ti.com/military
Optical Networking	www.ti.com/opticalnetwork
Security	www.ti.com/security
Telephony	www.ti.com/telephony
Video & Imaging	www.ti.com/video
Wireless	www.ti.com/wireless

Mailing Address: Texas Instruments, Post Office Box 655303, Dallas, Texas 75265
Copyright © 2008, Texas Instruments Incorporated