

FEATURES

- Member of the Texas Instruments Widebus™ Family
- EPIC™ (Enhanced-Performance Implanted CMOS) Submicron Process
- Output Ports Have Equivalent 26-Ω Series Resistors, So No External Resistors Are Required
- ESD Protection Exceeds 2000 V Per MIL-STD-883, Method 3015; Exceeds 200 V Using Machine Model (C = 200 pF, R = 0)
- Latch-Up Performance Exceeds 250 mA Per JESD 17
- Bus Hold on Data Inputs Eliminates the Need for External Pullup/Pulldown Resistors
- Package Options Include Plastic Shrink Small-Outline (DL) and Thin Shrink Small-Outline (DGG) Packages

NOTE: For tape-and-reel order entry, the DGG package is abbreviated to GR.

DESCRIPTION

This 10-bit flip-flop is designed for 1.65-V to 3.6-V V_{CC} operation.

The SN74ALVCH162820 flip-flops are edge-triggered D-type flip-flops. On the positive transition of the clock (CLK) input, the device provides true data at the Q outputs.

A buffered output-enable (\overline{OE}) input can be used to place the ten outputs in either a normal logic state (high or low logic levels) or the high-impedance state. In the high-impedance state, the outputs neither load nor drive the bus lines significantly. The high-impedance state and increased drive provide the capability to drive bus lines without need for interface or pullup components.

\overline{OE} does not affect the internal operations of the flip-flops. Old data can be retained or new data can be entered while the outputs are in the high-impedance state.

The outputs, which are designed to sink up to 12 mA, include equivalent 26-Ω resistors to reduce overshoot and undershoot.

To ensure the high-impedance state during power up or power down, \overline{OE} should be tied to V_{CC} through a pullup resistor; the minimum value of the resistor is determined by the current-sinking capability of the driver.

Active bus-hold circuitry is provided to hold unused or floating data inputs at a valid logic level.

The SN74ALVCH162820 is characterized for operation from -40°C to 85°C.

DGG OR DL PACKAGE
(TOP VIEW)

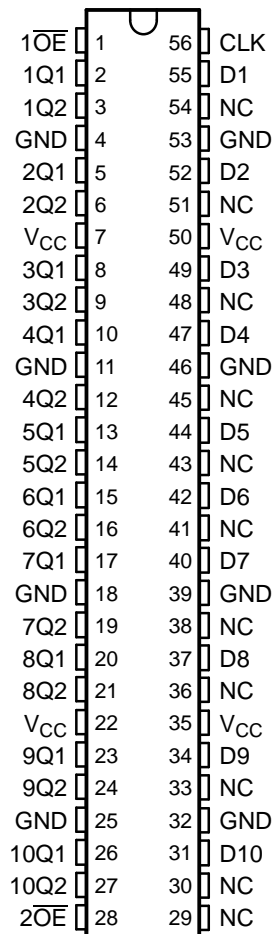

NC – No internal connection



Please be aware that an important notice concerning availability, standard warranty, and use in critical applications of Texas Instruments semiconductor products and disclaimers thereto appears at the end of this data sheet.

Widebus, EPIC are trademarks of Texas Instruments.

SN74ALVCH162820
3.3-V 10-BIT FLIP-FLOP WITH DUAL OUTPUTS
AND 3-STATE OUTPUTS

SCES012H–JULY 1995–REVISED SEPTEMBER 2004

FUNCTION TABLE
(each flip-flop)

INPUTS			OUTPUT Q
$\overline{OE}_n^{(1)}$	CLK	D	
L	↑	H	H
L	↑	L	L
L	L	X	Q_0
H	X	X	Z

(1) $n = 1, 2$

LOGIC DIAGRAM (POSITIVE LOGIC)

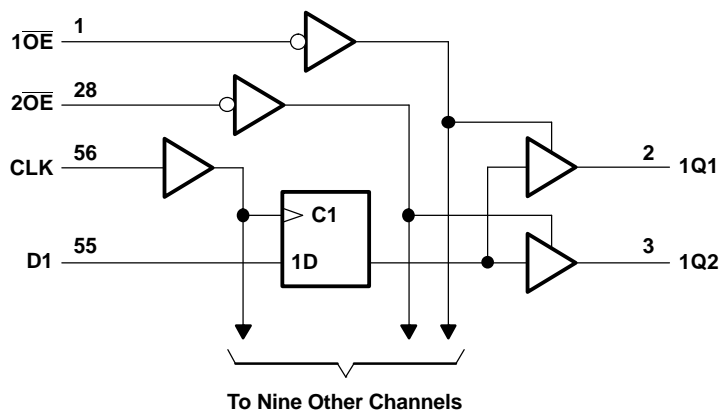

ABSOLUTE MAXIMUM RATINGS⁽¹⁾

over operating free-air temperature range (unless otherwise noted)

		MIN	MAX	UNIT
V_{CC}	Supply voltage range	-0.5	4.6	V
V_I	Input voltage range ⁽²⁾	-0.5	4.6	V
V_O	Output voltage range ⁽²⁾⁽³⁾	-0.5	$V_{CC} + 0.5$	V
I_{IK}	Input clamp current	$V_I < 0$	-50	mA
I_{OK}	Output clamp current	$V_O < 0$	-50	mA
I_O	Continuous output current		±50	mA
	Continuous current through each V_{CC} or GND		±100	mA
θ_{JA}	Package thermal impedance ⁽⁴⁾	DGG package	64	°C/W
		DL package	56	
T_{stg}	Storage temperature range	-65	150	°C

- (1) Stresses beyond those listed under "absolute maximum ratings" may cause permanent damage to the device. These are stress ratings only, and functional operation of the device at these or any other conditions beyond those indicated under "recommended operating conditions" is not implied. Exposure to absolute-maximum-rated conditions for extended periods may affect device reliability.
- (2) The input negative-voltage and output voltage ratings may be exceeded if the input and output current ratings are observed.
- (3) This value is limited to 4.6 V maximum.
- (4) The package thermal impedance is calculated in accordance with JESD 51.

RECOMMENDED OPERATING CONDITIONS⁽¹⁾

		MIN	MAX	UNIT
V_{CC}	Supply voltage	1.65	3.6	V
V_{IH}	High-level input voltage	$V_{CC} = 1.65\text{ V to }1.95\text{ V}$	$0.65 \times V_{CC}$	V
		$V_{CC} = 2.3\text{ V to }2.7\text{ V}$	1.7	
		$V_{CC} = 2.7\text{ V to }3.6\text{ V}$	2	
V_{IL}	Low-level input voltage	$V_{CC} = 1.65\text{ V to }1.95\text{ V}$	$0.35 \times V_{CC}$	V
		$V_{CC} = 2.3\text{ V to }2.7\text{ V}$	0.7	
		$V_{CC} = 2.7\text{ V to }3.6\text{ V}$	0.8	
V_I	Input voltage	0	V_{CC}	V
V_O	Output voltage	0	V_{CC}	V
I_{OH}	High-level output current	$V_{CC} = 1.65\text{ V}$	-2	mA
		$V_{CC} = 2.3\text{ V}$	-6	
		$V_{CC} = 2.7\text{ V}$	-8	
		$V_{CC} = 3\text{ V}$	-12	
I_{OL}	Low-level output current	$V_{CC} = 1.65\text{ V}$	2	mA
		$V_{CC} = 2.3\text{ V}$	6	
		$V_{CC} = 2.7\text{ V}$	8	
		$V_{CC} = 3\text{ V}$	12	
$\Delta t/\Delta v$	Input transition rise or fall rate		10	ns/V
T_A	Operating free-air temperature	-40	85	°C

(1) All unused control inputs of the device must be held at V_{CC} or GND to ensure proper device operation. Refer to the TI application report, *Implications of Slow or Floating CMOS Inputs*, literature number SCBA004.

SN74ALVCH162820
3.3-V 10-BIT FLIP-FLOP WITH DUAL OUTPUTS
AND 3-STATE OUTPUTS

SCES012H–JULY 1995–REVISED SEPTEMBER 2004

ELECTRICAL CHARACTERISTICS

over recommended operating free-air temperature range (unless otherwise noted)

PARAMETER	TEST CONDITIONS	V _{CC}	MIN	TYP ⁽¹⁾	MAX	UNIT
V _{OH}	I _{OH} = -100 μA	1.65 V to 3.6 V	V _{CC} - 0.2			V
	I _{OH} = -2 mA	1.65 V	1.2			
	I _{OH} = -4 mA	2.3 V	1.9			
	I _{OH} = -6 mA	2.3 V	1.7			
		3 V	2.4			
	I _{OH} = -8 mA	2.7 V	2			
I _{OH} = -12 mA	3 V	2				
V _{OL}	I _{OL} = 100 μA	1.65 V to 3.6 V	0.2			V
	I _{OL} = 2 mA	1.65 V	0.45			
	I _{OL} = 4 mA	2.3 V	0.4			
	I _{OL} = 6 mA	2.3 V	0.55			
		3 V	0.55			
	I _{OL} = 8 mA	2.7 V	0.6			
I _{OL} = 12 mA	3 V	0.8				
I _I	V _I = V _{CC} or GND	3.6 V	±5			μA
I _{I(hold)}	V _I = 0.58 V	1.65 V	25			μA
	V _I = 1.07 V	1.65 V	-25			
	V _I = 0.7 V	2.3 V	45			
	V _I = 1.7 V	2.3 V	-45			
	V _I = 0.8 V	3 V	75			
	V _I = 2 V	3 V	-75			
	V _I = 0 to 3.6 V ⁽²⁾	3.6 V	±500			
I _{OZ}	V _O = V _{CC} or GND	3.6 V	±10			μA
I _{CC}	V _I = V _{CC} or GND I _O = 0	3.6 V	40			μA
ΔI _{CC}	One input at V _{CC} - 0.6 V, Other inputs at V _{CC} or GND	3 V to 3.6 V	750			μA
C _i	Control inputs	V _I = V _{CC} or GND	3.5			pF
	Data inputs		6			
C _o	Outputs	V _O = V _{CC} or GND	7			pF

(1) All typical values are at V_{CC} = 3.3 V, T_A = 25°C.

(2) This is the bus-hold maximum dynamic current. It is the minimum overdrive current required to switch the input from one state to another.

TIMING REQUIREMENTS

over recommended operating free-air temperature range (unless otherwise noted) (see Figure 1 through Figure 3)

		V _{CC} = 1.8 V		V _{CC} = 2.5 V ± 0.2 V		V _{CC} = 2.7 V		V _{CC} = 3.3 V ± 0.3 V		UNIT
		MIN	MAX	MIN	MAX	MIN	MAX	MIN	MAX	
f _{clock}	Clock frequency	(1)		150		150		150		MHz
t _w	Pulse duration, CLK high or low	(1)		3.3		3.3		3.3		ns
t _{su}	Setup time, data before CLK↑	(1)		1.7		1.8		1.4		ns
t _h	Hold time, data after CLK↑	(1)		1.1		1.1		1		ns

(1) This information was not available at the time of publication.

SWITCHING CHARACTERISTICS

over recommended operating free-air temperature range (unless otherwise noted) (see Figure 1 through Figure 3)

PARAMETER	FROM (INPUT)	TO (OUTPUT)	$V_{CC} = 1.8\text{ V}$		$V_{CC} = 2.5\text{ V}$ $\pm 0.2\text{ V}$		$V_{CC} = 2.7\text{ V}$		$V_{CC} = 3.3\text{ V}$ $\pm 0.3\text{ V}$		UNIT
			MIN	TYP	MIN	MAX	MIN	MAX	MIN	MAX	
f_{\max}			(1)		150		150		150		MHz
t_{pd}	CLK	Q		(1)	1	6.4		6.2	1	5.4	ns
t_{en}	\overline{OE}	Q		(1)	1	6.9		6.8	1	5.6	ns
t_{dis}	\overline{OE}	Q		(1)	1	6.2		5.5	1	5	ns

(1) This information was not available at the time of publication.

OPERATING CHARACTERISTICS

$T_A = 25^\circ\text{C}$

PARAMETER		TEST CONDITIONS	$V_{CC} = 1.8\text{ V}$	$V_{CC} = 2.5\text{ V}$	$V_{CC} = 3.3\text{ V}$	UNIT
			TYP	TYP	TYP	
C_{pd}	Power dissipation capacitance per flip-flop	All outputs enabled	(1)	68	66	pF
		All outputs disabled	(1)	39	47	

(1) This information was not available at the time of publication.

PARAMETER MEASUREMENT INFORMATION

$V_{CC} = 1.8\text{ V}$

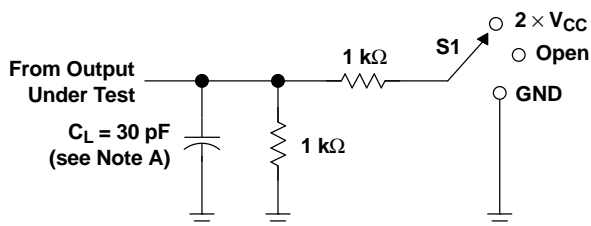

LOAD CIRCUIT

TEST	S1
t_{pd}	Open
t_{PLZ}/t_{PZL}	2 \times V_{CC}
t_{PHZ}/t_{PZH}	GND

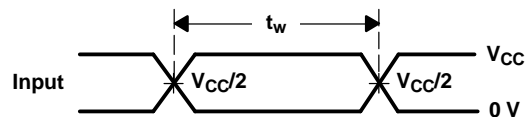
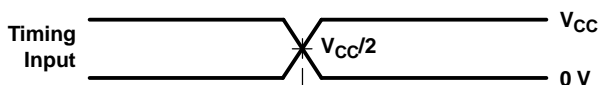

VOLTAGE WAVEFORMS
 PULSE DURATION

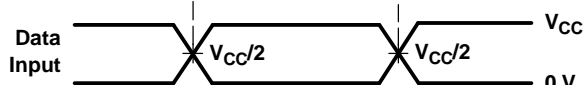

VOLTAGE WAVEFORMS
 SETUP AND HOLD TIMES

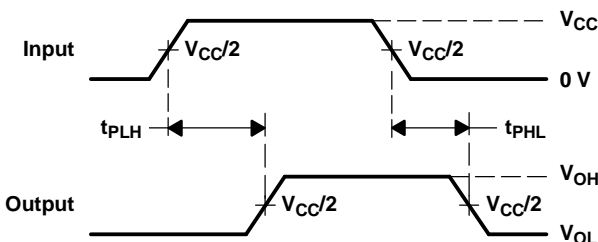
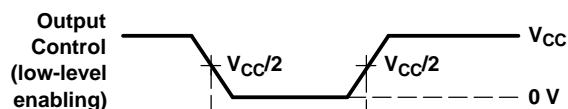

VOLTAGE WAVEFORMS
 PROPAGATION DELAY TIMES

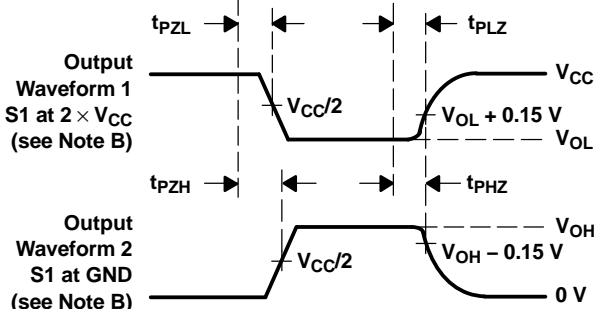

VOLTAGE WAVEFORMS
 ENABLE AND DISABLE TIMES

- NOTES: A. C_L includes probe and jig capacitance.
 B. Waveform 1 is for an output with internal conditions such that the output is low, except when disabled by the output control. Waveform 2 is for an output with internal conditions such that the output is high, except when disabled by the output control.
 C. All input pulses are supplied by generators having the following characteristics: $PRR \leq 10\text{ MHz}$, $Z_O = 50\ \Omega$, $t_r \leq 2\text{ ns}$, $t_f \leq 2\text{ ns}$.
 D. The outputs are measured one at a time, with one transition per measurement.
 E. t_{PLZ} and t_{PHZ} are the same as t_{dis} .
 F. t_{PZL} and t_{PZH} are the same as t_{en} .
 G. t_{PLH} and t_{PHL} are the same as t_{pd} .

Figure 1. Load Circuit and Voltage Waveforms

PARAMETER MEASUREMENT INFORMATION

$V_{CC} = 2.5 \text{ V} \pm 0.2 \text{ V}$

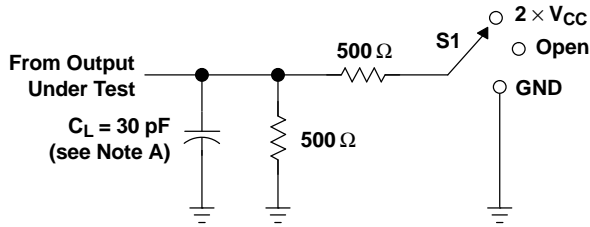

LOAD CIRCUIT

TEST	S1
t_{pd}	Open
t_{PLZ}/t_{PZL}	2 $\times V_{CC}$
t_{PHZ}/t_{PZH}	GND

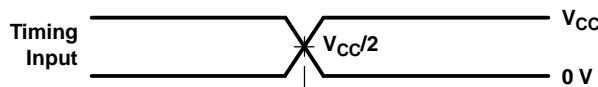

VOLTAGE WAVEFORMS
PULSE DURATION

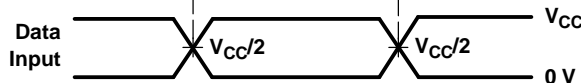

VOLTAGE WAVEFORMS
SETUP AND HOLD TIMES

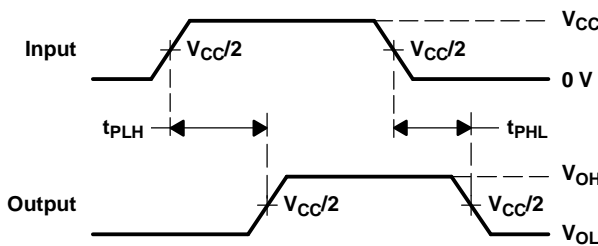
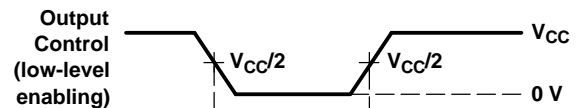

VOLTAGE WAVEFORMS
PROPAGATION DELAY TIMES

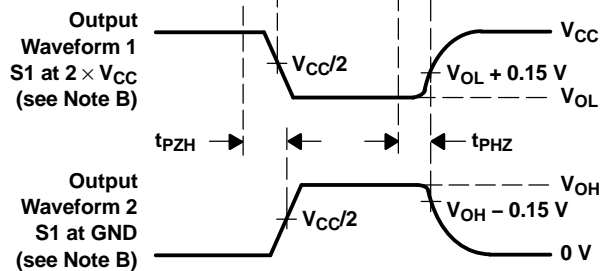

VOLTAGE WAVEFORMS
ENABLE AND DISABLE TIMES

- NOTES: A. C_L includes probe and jig capacitance.
 B. Waveform 1 is for an output with internal conditions such that the output is low, except when disabled by the output control. Waveform 2 is for an output with internal conditions such that the output is high, except when disabled by the output control.
 C. All input pulses are supplied by generators having the following characteristics: $PRR \leq 10 \text{ MHz}$, $Z_O = 50 \Omega$, $t_r \leq 2 \text{ ns}$, $t_f \leq 2 \text{ ns}$.
 D. The outputs are measured one at a time, with one transition per measurement.
 E. t_{PLZ} and t_{PHZ} are the same as t_{dis} .
 F. t_{PZL} and t_{PZH} are the same as t_{en} .
 G. t_{PLH} and t_{PHL} are the same as t_{pd} .

Figure 2. Load Circuit and Voltage Waveforms

PARAMETER MEASUREMENT INFORMATION

$V_{CC} = 2.7\text{ V}$ AND $3.3\text{ V} \pm 0.3\text{ V}$

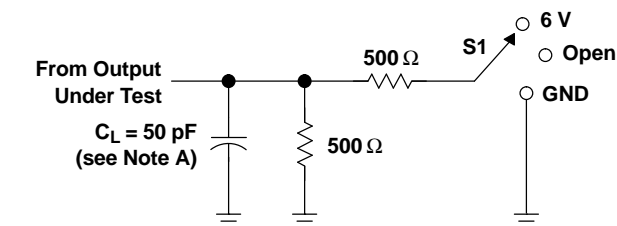

LOAD CIRCUIT

TEST	S1
t_{pd}	Open
t_{PLZ}/t_{PZL}	6 V
t_{PHZ}/t_{PZH}	GND

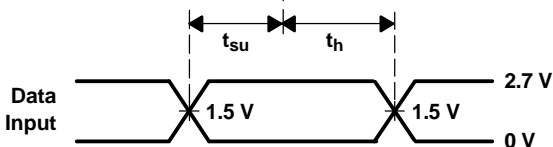
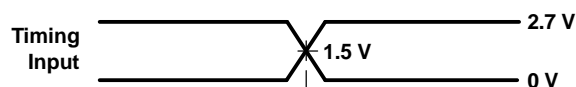

VOLTAGE WAVEFORMS
 SETUP AND HOLD TIMES

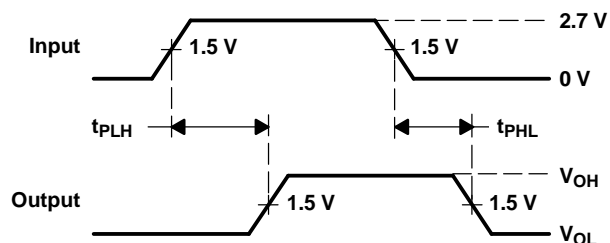

VOLTAGE WAVEFORMS
 PROPAGATION DELAY TIMES

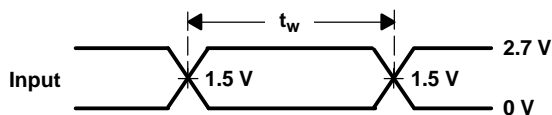

VOLTAGE WAVEFORMS
 PULSE DURATION

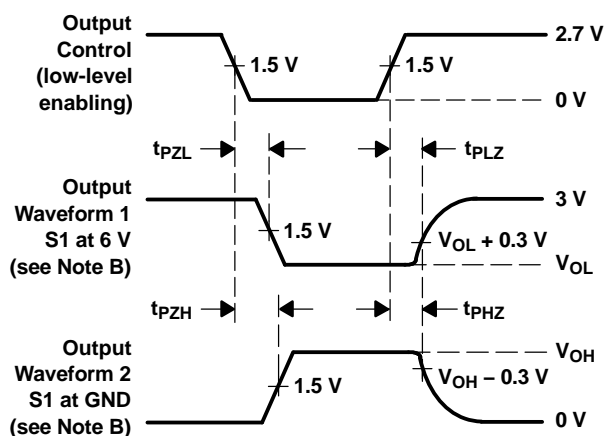

VOLTAGE WAVEFORMS
 ENABLE AND DISABLE TIMES

- NOTES: A. C_L includes probe and jig capacitance.
 B. Waveform 1 is for an output with internal conditions such that the output is low, except when disabled by the output control. Waveform 2 is for an output with internal conditions such that the output is high, except when disabled by the output control.
 C. All input pulses are supplied by generators having the following characteristics: PRR $\leq 10\text{ MHz}$, $Z_O = 50\ \Omega$, $t_r \leq 2.5\text{ ns}$, $t_f \leq 2.5\text{ ns}$.
 D. The outputs are measured one at a time, with one transition per measurement.
 E. t_{PLZ} and t_{PHZ} are the same as t_{dis} .
 F. t_{PZL} and t_{PZH} are the same as t_{en} .
 G. t_{PLH} and t_{PHL} are the same as t_{pd} .

Figure 3. Load Circuit and Voltage Waveforms

PACKAGING INFORMATION

Orderable Device	Status ⁽¹⁾	Package Type	Package Drawing	Pins	Package Qty	Eco Plan ⁽²⁾	Lead/ Ball Finish	MSL Peak Temp ⁽³⁾	Samples (Requires Login)
74ALVCH162820DLG4	ACTIVE	SSOP	DL	56	20	Green (RoHS & no Sb/Br)	CU NIPDAU	Level-1-260C-UNLIM	Contact TI Distributor or Sales Office
74ALVCH162820DLRG4	ACTIVE	SSOP	DL	56	1000	Green (RoHS & no Sb/Br)	CU NIPDAU	Level-1-260C-UNLIM	Purchase Samples
SN74ALVCH162820DGGR	OBSOLETE	TSSOP	DGG	56		TBD	Call TI	Call TI	
SN74ALVCH162820DL	ACTIVE	SSOP	DL	56	20	Green (RoHS & no Sb/Br)	CU NIPDAU	Level-1-260C-UNLIM	Contact TI Distributor or Sales Office
SN74ALVCH162820DLR	ACTIVE	SSOP	DL	56	1000	Green (RoHS & no Sb/Br)	CU NIPDAU	Level-1-260C-UNLIM	Purchase Samples

⁽¹⁾ The marketing status values are defined as follows:

ACTIVE: Product device recommended for new designs.

LIFEBUY: TI has announced that the device will be discontinued, and a lifetime-buy period is in effect.

NRND: Not recommended for new designs. Device is in production to support existing customers, but TI does not recommend using this part in a new design.

PREVIEW: Device has been announced but is not in production. Samples may or may not be available.

OBSOLETE: TI has discontinued the production of the device.

⁽²⁾ Eco Plan - The planned eco-friendly classification: Pb-Free (RoHS), Pb-Free (RoHS Exempt), or Green (RoHS & no Sb/Br) - please check <http://www.ti.com/productcontent> for the latest availability information and additional product content details.

TBD: The Pb-Free/Green conversion plan has not been defined.

Pb-Free (RoHS): TI's terms "Lead-Free" or "Pb-Free" mean semiconductor products that are compatible with the current RoHS requirements for all 6 substances, including the requirement that lead not exceed 0.1% by weight in homogeneous materials. Where designed to be soldered at high temperatures, TI Pb-Free products are suitable for use in specified lead-free processes.

Pb-Free (RoHS Exempt): This component has a RoHS exemption for either 1) lead-based flip-chip solder bumps used between the die and package, or 2) lead-based die adhesive used between the die and leadframe. The component is otherwise considered Pb-Free (RoHS compatible) as defined above.

Green (RoHS & no Sb/Br): TI defines "Green" to mean Pb-Free (RoHS compatible), and free of Bromine (Br) and Antimony (Sb) based flame retardants (Br or Sb do not exceed 0.1% by weight in homogeneous material)

⁽³⁾ MSL, Peak Temp. -- The Moisture Sensitivity Level rating according to the JEDEC industry standard classifications, and peak solder temperature.

Important Information and Disclaimer: The information provided on this page represents TI's knowledge and belief as of the date that it is provided. TI bases its knowledge and belief on information provided by third parties, and makes no representation or warranty as to the accuracy of such information. Efforts are underway to better integrate information from third parties. TI has taken and continues to take reasonable steps to provide representative and accurate information but may not have conducted destructive testing or chemical analysis on incoming materials and chemicals. TI and TI suppliers consider certain information to be proprietary, and thus CAS numbers and other limited information may not be available for release.

In no event shall TI's liability arising out of such information exceed the total purchase price of the TI part(s) at issue in this document sold by TI to Customer on an annual basis.

TAPE AND REEL INFORMATION

REEL DIMENSIONS



TAPE DIMENSIONS



A0	Dimension designed to accommodate the component width
B0	Dimension designed to accommodate the component length
K0	Dimension designed to accommodate the component thickness
W	Overall width of the carrier tape
P1	Pitch between successive cavity centers

TAPE AND REEL INFORMATION

*All dimensions are nominal

Device	Package Type	Package Drawing	Pins	SPQ	Reel Diameter (mm)	Reel Width W1 (mm)	A0 (mm)	B0 (mm)	K0 (mm)	P1 (mm)	W (mm)	Pin1 Quadrant
SN74ALVCH162820DLR	SSOP	DL	56	1000	330.0	32.4	11.35	18.67	3.1	16.0	32.0	Q1

TAPE AND REEL BOX DIMENSIONS

*All dimensions are nominal

Device	Package Type	Package Drawing	Pins	SPQ	Length (mm)	Width (mm)	Height (mm)
SN74ALVCH162820DLR	SSOP	DL	56	1000	367.0	367.0	55.0

DL (R-PDSO-G**)

PLASTIC SMALL-OUTLINE PACKAGE

48 PINS SHOWN



- NOTES: A. All linear dimensions are in inches (millimeters).
 B. This drawing is subject to change without notice.
 C. Body dimensions do not include mold flash or protrusion not to exceed 0.006 (0,15).
 D. Falls within JEDEC MO-118

DGG (R-PDSO-G**)

PLASTIC SMALL-OUTLINE PACKAGE

48 PINS SHOWN



- NOTES: A. All linear dimensions are in millimeters.
 B. This drawing is subject to change without notice.
 C. Body dimensions do not include mold protrusion not to exceed 0,15.
 D. Falls within JEDEC MO-153

IMPORTANT NOTICE

Texas Instruments Incorporated and its subsidiaries (TI) reserve the right to make corrections, enhancements, improvements and other changes to its semiconductor products and services per JESD46C and to discontinue any product or service per JESD48B. Buyers should obtain the latest relevant information before placing orders and should verify that such information is current and complete. All semiconductor products (also referred to herein as "components") are sold subject to TI's terms and conditions of sale supplied at the time of order acknowledgment.

TI warrants performance of its components to the specifications applicable at the time of sale, in accordance with the warranty in TI's terms and conditions of sale of semiconductor products. Testing and other quality control techniques are used to the extent TI deems necessary to support this warranty. Except where mandated by applicable law, testing of all parameters of each component is not necessarily performed.

TI assumes no liability for applications assistance or the design of Buyers' products. Buyers are responsible for their products and applications using TI components. To minimize the risks associated with Buyers' products and applications, Buyers should provide adequate design and operating safeguards.

TI does not warrant or represent that any license, either express or implied, is granted under any patent right, copyright, mask work right, or other intellectual property right relating to any combination, machine, or process in which TI components or services are used. Information published by TI regarding third-party products or services does not constitute a license to use such products or services or a warranty or endorsement thereof. Use of such information may require a license from a third party under the patents or other intellectual property of the third party, or a license from TI under the patents or other intellectual property of TI.

Reproduction of significant portions of TI information in TI data books or data sheets is permissible only if reproduction is without alteration and is accompanied by all associated warranties, conditions, limitations, and notices. TI is not responsible or liable for such altered documentation. Information of third parties may be subject to additional restrictions.

Resale of TI components or services with statements different from or beyond the parameters stated by TI for that component or service voids all express and any implied warranties for the associated TI component or service and is an unfair and deceptive business practice. TI is not responsible or liable for any such statements.

Buyer acknowledges and agrees that it is solely responsible for compliance with all legal, regulatory and safety-related requirements concerning its products, and any use of TI components in its applications, notwithstanding any applications-related information or support that may be provided by TI. Buyer represents and agrees that it has all the necessary expertise to create and implement safeguards which anticipate dangerous consequences of failures, monitor failures and their consequences, lessen the likelihood of failures that might cause harm and take appropriate remedial actions. Buyer will fully indemnify TI and its representatives against any damages arising out of the use of any TI components in safety-critical applications.

In some cases, TI components may be promoted specifically to facilitate safety-related applications. With such components, TI's goal is to help enable customers to design and create their own end-product solutions that meet applicable functional safety standards and requirements. Nonetheless, such components are subject to these terms.

No TI components are authorized for use in FDA Class III (or similar life-critical medical equipment) unless authorized officers of the parties have executed a special agreement specifically governing such use.

Only those TI components which TI has specifically designated as military grade or "enhanced plastic" are designed and intended for use in military/aerospace applications or environments. Buyer acknowledges and agrees that any military or aerospace use of TI components which have **not** been so designated is solely at the Buyer's risk, and that Buyer is solely responsible for compliance with all legal and regulatory requirements in connection with such use.

TI has specifically designated certain components which meet ISO/TS16949 requirements, mainly for automotive use. Components which have not been so designated are neither designed nor intended for automotive use; and TI will not be responsible for any failure of such components to meet such requirements.

Products

Audio	www.ti.com/audio
Amplifiers	amplifier.ti.com
Data Converters	dataconverter.ti.com
DLP® Products	www.dlp.com
DSP	dsp.ti.com
Clocks and Timers	www.ti.com/clocks
Interface	interface.ti.com
Logic	logic.ti.com
Power Mgmt	power.ti.com
Microcontrollers	microcontroller.ti.com
RFID	www.ti-rfid.com
OMAP Mobile Processors	www.ti.com/omap
Wireless Connectivity	www.ti.com/wirelessconnectivity

Applications

Automotive and Transportation	www.ti.com/automotive
Communications and Telecom	www.ti.com/communications
Computers and Peripherals	www.ti.com/computers
Consumer Electronics	www.ti.com/consumer-apps
Energy and Lighting	www.ti.com/energy
Industrial	www.ti.com/industrial
Medical	www.ti.com/medical
Security	www.ti.com/security
Space, Avionics and Defense	www.ti.com/space-avionics-defense
Video and Imaging	www.ti.com/video

TI E2E Community e2e.ti.com