



Gates, Series 54/74

DM5404/DM7404 (SN5404/SN7404) hex inverter

general description

The DM5404/DM7404 is a hex inverter utilizing TTL to achieve high speed at nominal power dissipation. It is totally compatible with other Series 54/74 devices.

Features include:

- Input clamping diodes
- Typical Noise Immunity 1V

- Guaranteed Noise Immunity 400 mV
- Fan-out 10
- Allowable Power Supply Variation

DM5404	4.5V to 5.5V
DM7404	4.75V to 5.25V
- Average Propagation Delay 12 ns (with 50 pF)
- Average Power Dissipation 10 mW per gate

schematic and connection diagrams

DM5404/DM7404

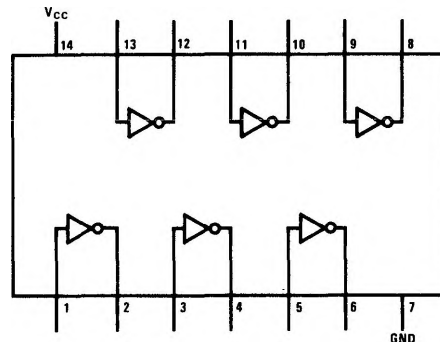
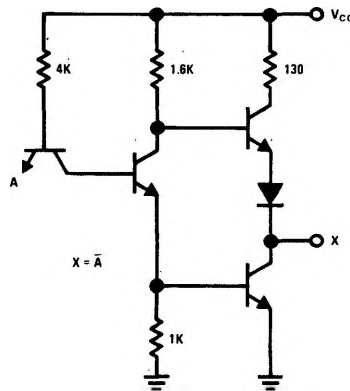

absolute maximum ratings

V_{CC}	7V
Input Voltage	5.5V
Operating Temperature Range	
DM7404	0°C to 70°C
DM5404	-55°C to +125°C
Storage Temperature Range	-65°C to +150°C
Lead Temperature (soldering, 10 sec)	300°C

electrical characteristics (Note 1)

PARAMETER	CONDITIONS		MIN	TYP	MAX	UNITS
Input diode clamp voltage	$V_{CC} = 5.0V$ $I_{IN} = -12 mA$	$T_A = 25^\circ C$			-1.5	V
Logical "1" Input Voltage	DM5404 $V_{CC} = 4.5V$ DM7404 $V_{CC} = 4.75V$		2.0			V
Logical "0" Input Voltage	DM5404 $V_{CC} = 4.5V$ DM7404 $V_{CC} = 4.75V$				0.8	V
Logical "1" Output Voltage	DM5404 $V_{CC} = 4.5V$ DM7404 $V_{CC} = 4.75V$	$V_{IN} = 0.8V, I_{OUT} = -400 \mu A$	2.4			V
Logical "0" Output Voltage	DM5404 $V_{CC} = 4.5V$ DM7404 $V_{CC} = 4.75V$	$V_{IN} = 2.0V, I_{OUT} = 16 mA$			0.4	V
Logical "1" Input Current	DM5404 $V_{CC} = 5.5V$ DM7404 $V_{CC} = 5.25V$	$V_{IN} = 2.4V$			40	μA
Logical "1" Input Current	DM5404 $V_{CC} = 5.5V$ DM7404 $V_{CC} = 5.25V$	$V_{IN} = 5.5V$			1	mA
Logical "0" Input Current	DM5404 $V_{CC} = 5.5V$ DM7404 $V_{CC} = 5.25V$	$V_{IN} = 0.4V$		-1.0	-1.6	mA
Output Short Circuit Current (Note 2)	DM5404 $V_{CC} = 5.5V$ DM7404 $V_{CC} = 5.25V$	$V_{OUT} = 0$	-20 -18	-30	-55	mA
Supply Current - Logical "0" (each gate)	DM5404 $V_{CC} = 5.5V$ DM7404 $V_{CC} = 5.25V$	$V_{IN} = 5.0V$		3.0	5.1	mA
Supply Current - Logical "1" (each gate)	DM5404 $V_{CC} = 5.5V$ DM7404 $V_{CC} = 5.25V$	$V_{IN} = 0$		1.0	1.8	mA
Propagation Delay to a Logical "1", t_{pd1}	$T_A = 25^\circ C$ N = 10	$V_{CC} = 5.0V$ C = 50 pF	5	16	22	ns
Propagation Delay to a Logical "0" t_{pd0}	$T_A = 25^\circ C$ N = 10	$V_{CC} = 5.0V$ C = 50 pF	3	9	15	ns

Note 1. Min/Max limits apply across the guaranteed temperature range of 0°C to 70°C for the DM7404, and -55°C to +125°C for the DM5404, unless otherwise specified. All typicals are given for $V_{CC} = 5.0V$ and $T_A = 25^\circ C$.

Note 2. Only one output at a time should be short circuited.

typical performance characteristics

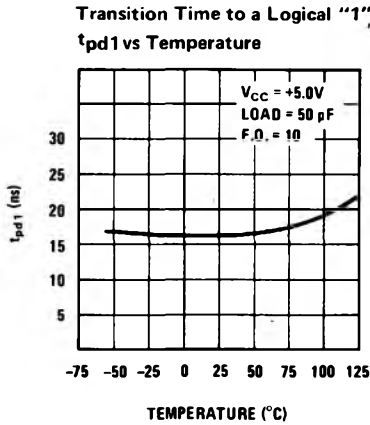
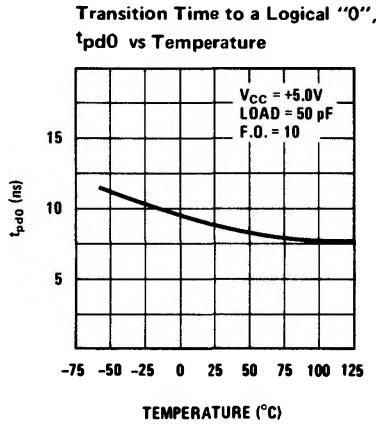
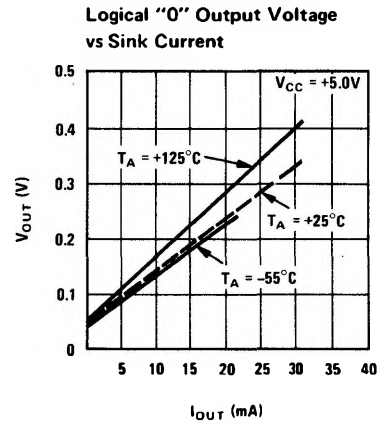
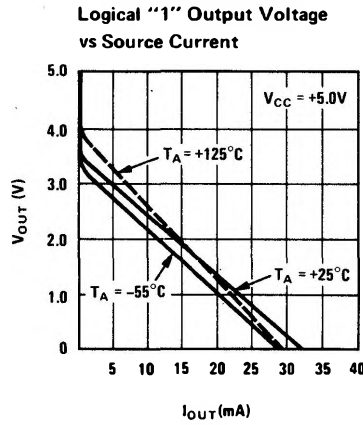
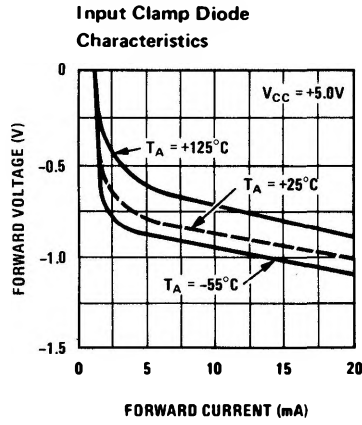

ac test circuit

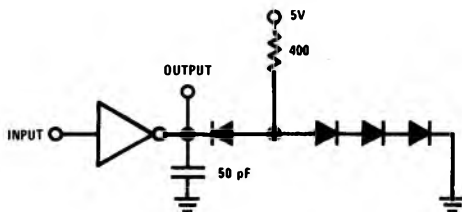

switching time waveform

