

## FEATURES

- Avalanche Rugged Technology
- Rugged Gate Oxide Technology
- Lower Input Capacitance
- Improved Gate Charge
- 175°C Operating Temperature
- Extended Safe Operating Area
- Lower Leakage Current : 10  $\mu$ A (Max.) @  $V_{DS} = -100V$
- Lower  $R_{DS(ON)}$  : 0.161  $\Omega$  (Typ.)

$$BV_{DSS} = -100 V$$

$$R_{DS(on)} = 0.2 \Omega$$

$$I_D = -13.2 A$$

### TO-3PF

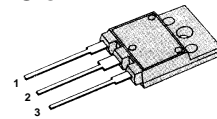

1.Gate 2. Drain 3. Source

## Absolute Maximum Ratings

Symbol	Characteristic	Value	Units
$V_{DSS}$	Drain-to-Source Voltage	-100	V
$I_D$	Continuous Drain Current ( $T_C=25^\circ C$ )	-13.2	A
	Continuous Drain Current ( $T_C=100^\circ C$ )	-9.2	
$I_{DM}$	Drain Current-Pulsed ①	53	A
$V_{GS}$	Gate-to-Source Voltage	+ 20	V
$E_{AS}$	Single Pulsed Avalanche Energy ②	348	mJ
$I_{AR}$	Avalanche Current ①	-13.2	A
$E_{AR}$	Repetitive Avalanche Energy ①	8.0	mJ
dv/dt	Peak Diode Recovery dv/dt ③	-6.5	V/ns
$P_D$	Total Power Dissipation ( $T_C=25^\circ C$ )	80	W
	Linear Derating Factor	0.53	
$T_J, T_{STG}$	Operating Junction and Storage Temperature Range	- 55 to +175	$^\circ C$
$T_L$	Maximum Lead Temp. for Soldering Purposes, 1/8" from case for 5-seconds	300	

## Thermal Resistance

Symbol	Characteristic	Typ.	Max.	Units
$R_{\theta JC}$	Junction-to-Case	--	1.88	$^\circ C/W$
$R_{\theta JA}$	Junction-to-Ambient	--	40	

### Electrical Characteristics ( $T_C=25^\circ\text{C}$ unless otherwise specified)

Symbol	Characteristic	Min.	Typ.	Max.	Units	Test Condition
$BV_{DSS}$	Drain-Source Breakdown Voltage	-100	--	--	V	$V_{GS}=0V, I_D=-250\mu A$
$\Delta BV/\Delta T_J$	Breakdown Voltage Temp. Coeff.	--	-0.11	--	V/ $^\circ\text{C}$	$I_D=-250\mu A$ <b>See Fig 7</b>
$V_{GS(th)}$	Gate Threshold Voltage	-2.0	--	-4.0	V	$V_{DS}=-5V, I_D=-250\mu A$
$I_{GSS}$	Gate-Source Leakage, Forward	--	--	-100	nA	$V_{GS}=-20V$
	Gate-Source Leakage, Reverse	--	--	100		$V_{GS}=20V$
$I_{DSS}$	Drain-to-Source Leakage Current	--	--	-10	$\mu A$	$V_{DS}=-100V$
		--	--	-100		$V_{DS}=-80V, T_C=150^\circ\text{C}$
$R_{DS(on)}$	Static Drain-Source On-State Resistance	--	--	0.2	$\Omega$	$V_{GS}=-10V, I_D=-6.6A$ ④
$g_{fs}$	Forward Transconductance	--	8.9	--	$\text{S}$	$V_{DS}=-40V, I_D=-6.6A$ ④
$C_{iss}$	Input Capacitance	--	1180	1535	pF	$V_{GS}=0V, V_{DS}=-25V, f=1\text{MHz}$ <b>See Fig 5</b>
$C_{oss}$	Output Capacitance	--	240	360		
$C_{rss}$	Reverse Transfer Capacitance	--	83	125		
$t_{d(on)}$	Turn-On Delay Time	--	14	40	ns	$V_{DD}=-50V, I_D=-17A,$ $R_G=12\Omega$ <b>See Fig 13</b> ④⑤
$t_r$	Rise Time	--	22	55		
$t_{d(off)}$	Turn-Off Delay Time	--	45	100		
$t_f$	Fall Time	--	26	60		
$Q_g$	Total Gate Charge	--	43	54	nC	$V_{DS}=-80V, V_{GS}=-10V,$ $I_D=-17A$ <b>See Fig 6 &amp; Fig 12</b> ④⑤
$Q_{gs}$	Gate-Source Charge	--	7.4	--		
$Q_{gd}$	Gate-Drain( " Miller " ) Charge	--	17.8	--		

### Source-Drain Diode Ratings and Characteristics

Symbol	Characteristic	Min.	Typ.	Max.	Units	Test Condition
$I_S$	Continuous Source Current	--	--	-13.2	A	Integral reverse pn-diode in the MOSFET
$I_{SM}$	Pulsed-Source Current ①	--	--	-53		
$V_{SD}$	Diode Forward Voltage ④	--	--	-4.0	V	$T_J=25^\circ\text{C}, I_S=-13.2A, V_{GS}=0V$
$t_{rr}$	Reverse Recovery Time	--	135	--	ns	$T_J=25^\circ\text{C}, I_F=-17A$
$Q_{rr}$	Reverse Recovery Charge	--	0.7	--	$\mu\text{C}$	$di_F/dt=100A/\mu\text{s}$ ④

#### Notes ;

- ① Repetitive Rating : Pulse Width Limited by Maximum Junction Temperature
- ②  $L=3.0\text{mH}, I_{AS}=-13.2A, V_{DD}=-25V, R_G=27\Omega^*,$  Starting  $T_J=25^\circ\text{C}$
- ③  $I_{SD} \leq -17A, di/dt \leq 450A/\mu\text{s}, V_{DD} \leq BV_{DSS},$  Starting  $T_J=25^\circ\text{C}$
- ④ Pulse Test : Pulse Width = 250  $\mu\text{s}$ , Duty Cycle  $\leq 2\%$
- ⑤ Essentially Independent of Operating Temperature

Fig 1. Output Characteristics

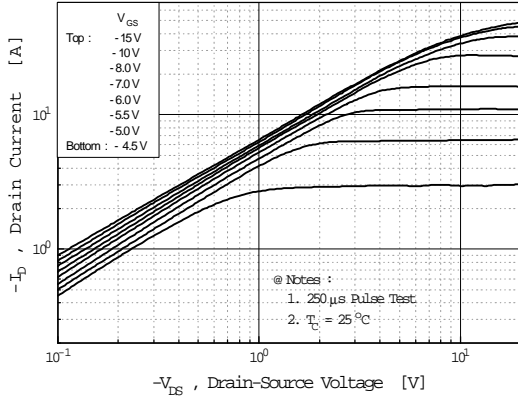

Fig 2. Transfer Characteristics

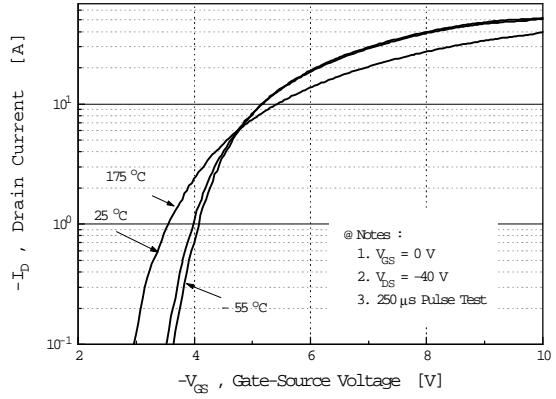

Fig 3. On-Resistance vs. Drain Current

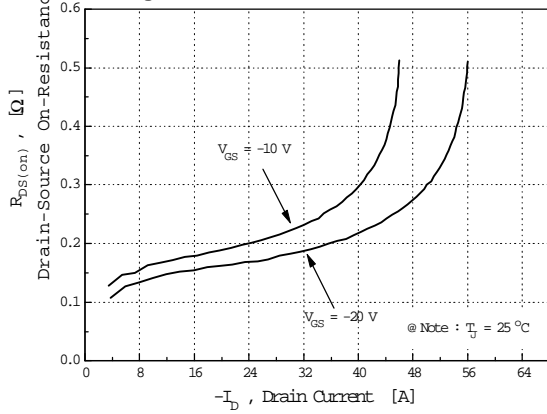

Fig 4. Source-Drain Diode Forward Voltage

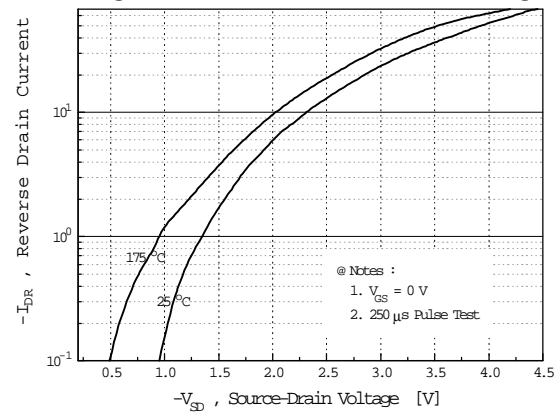

Fig 5. Capacitance vs. Drain-Source Voltage

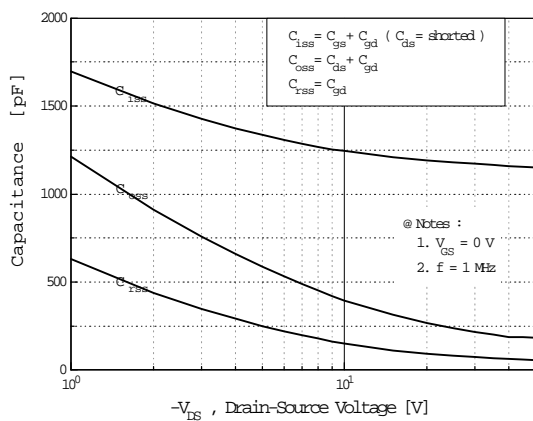
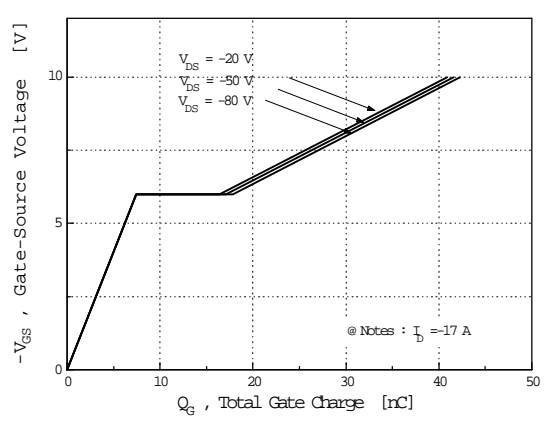
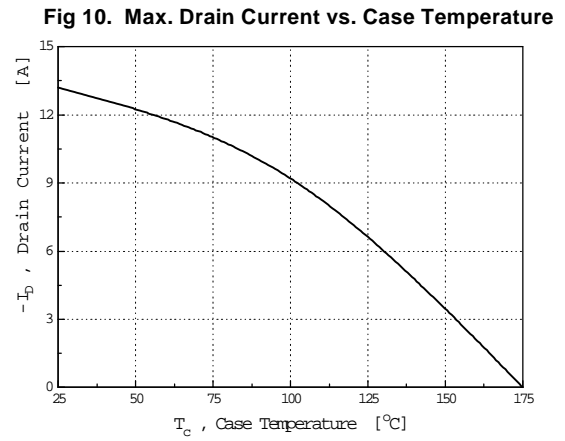
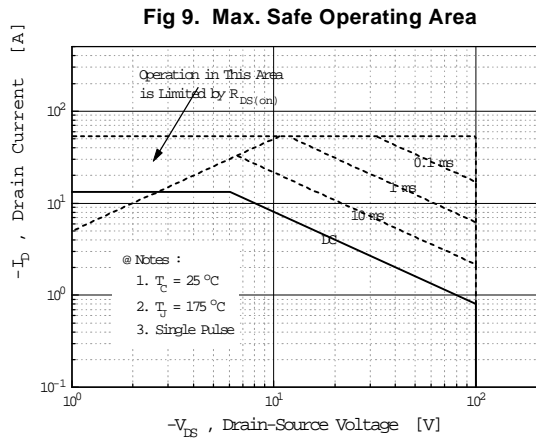
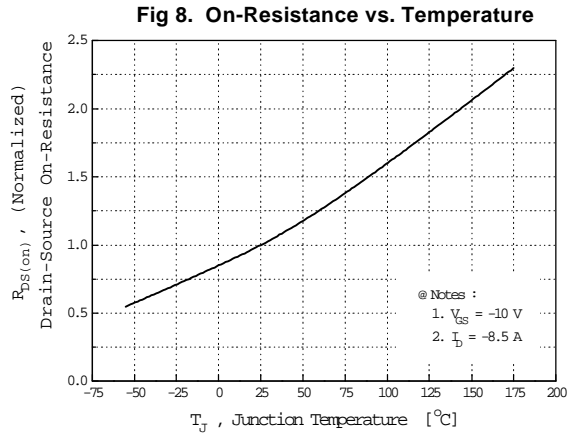
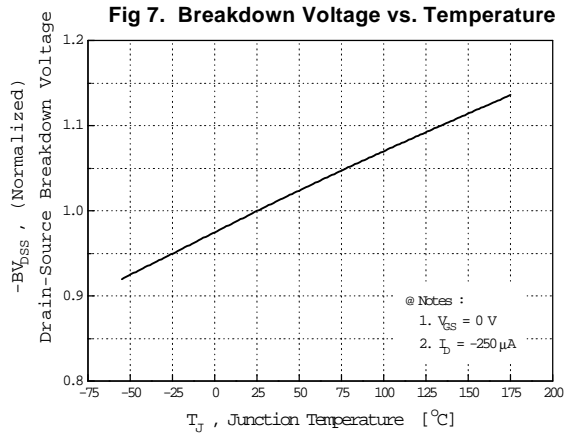

Fig 6. Gate Charge vs. Gate-Source Voltage





**Fig 11. Thermal Response**

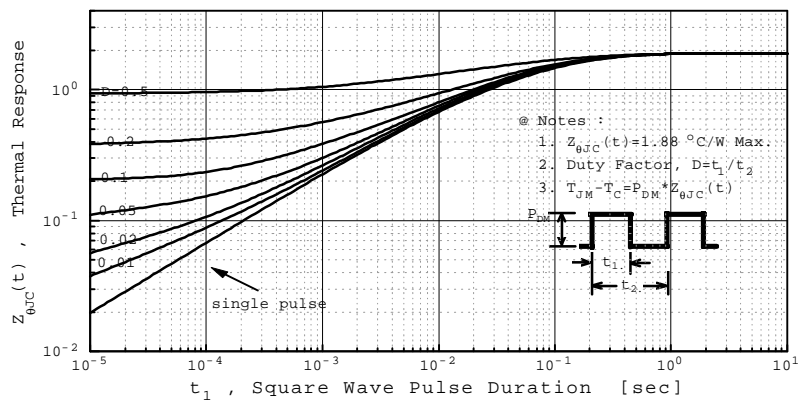

Fig 12. Gate Charge Test Circuit & Waveform

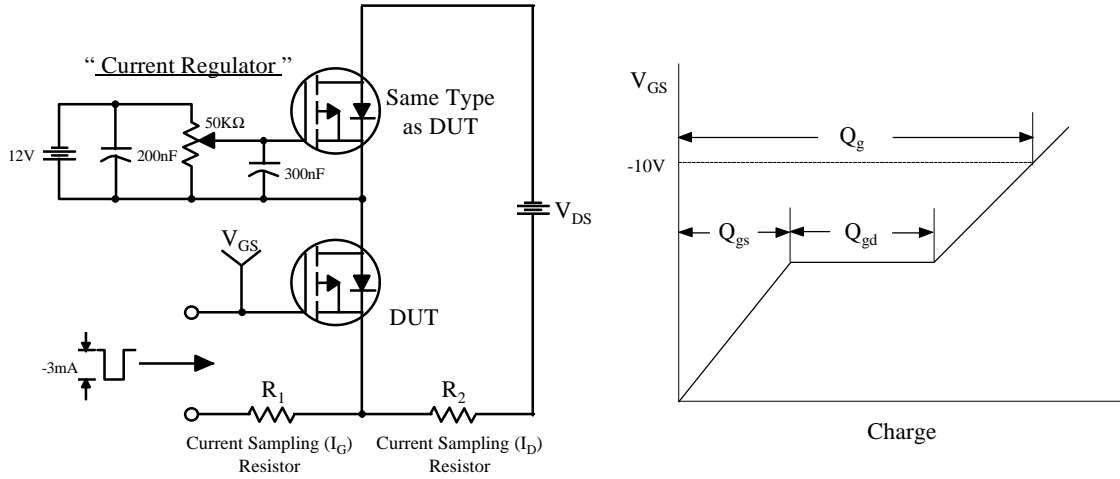

Fig 13. Resistive Switching Test Circuit & Waveforms

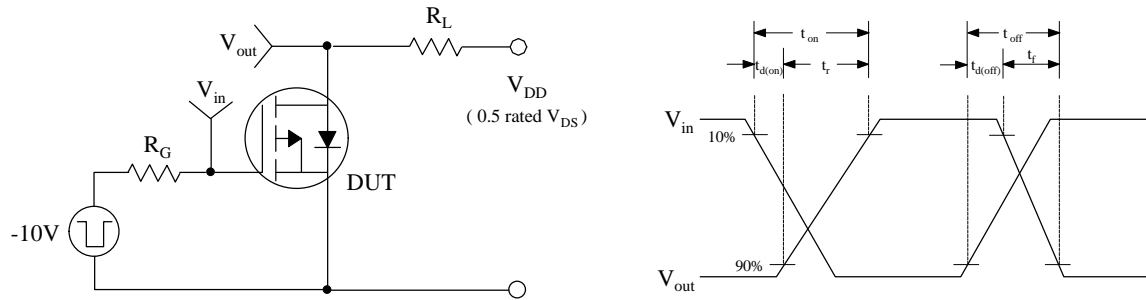

Fig 14. Unclamped Inductive Switching Test Circuit & Waveforms

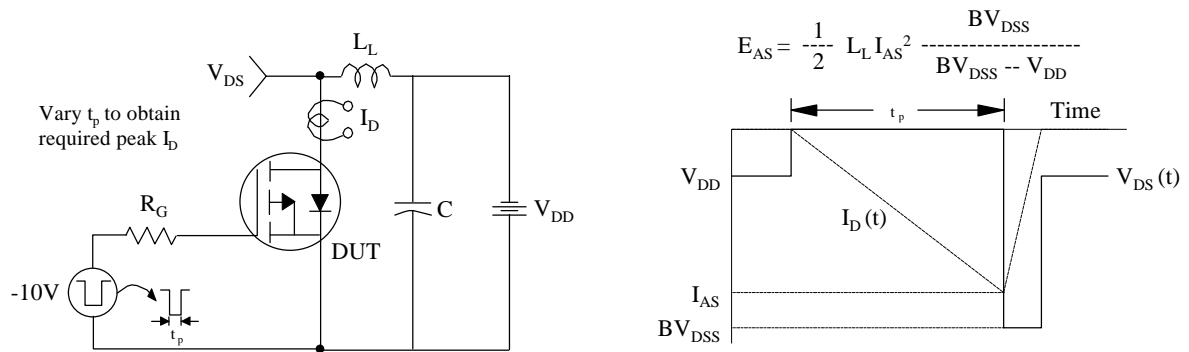

Fig 15. Peak Diode Recovery dv/dt Test Circuit & Waveforms

