

DATA SHEET



SAA8113HL Digital PC-camera signal processor

Preliminary specification
File under Integrated Circuits, IC22

1999 Sep 27

Digital PC-camera signal processor**SAA8113HL****CONTENTS**

1	FEATURES
2	APPLICATIONS
3	GENERAL DESCRIPTION
4	ORDERING INFORMATION
5	QUICK REFERENCE DATA
6	BLOCK DIAGRAM
7	PINNING
8	FUNCTIONAL DESCRIPTION
8.1	Black offset preprocessing
8.2	Y, C _R and C _B separation
8.3	RGB processing
8.4	Y processing
8.5	RGB to UV conversion
8.6	UV processing
8.7	Display function
8.8	Analog output processing
8.9	Measurement engine
8.10	VH reference and window timing and control
8.11	Pulse pattern generator
8.12	Miscellaneous functions
8.13	Mode control
8.14	Microcontroller
8.15	Audio amplifier
8.16	I ² C-bus interface
9	LIMITING VALUES
10	THERMAL CHARACTERISTICS
11	OPERATING CHARACTERISTICS
12	ELECTRICAL CHARACTERISTICS
13	APPLICATION INFORMATION
14	PACKAGE OUTLINE
15	SOLDERING
15.1	Introduction to soldering surface mount packages
15.2	Reflow soldering
15.3	Wave soldering
15.4	Manual soldering
15.5	Suitability of surface mount IC packages for wave and reflow soldering methods
16	DEFINITIONS
17	LIFE SUPPORT APPLICATIONS
18	PURCHASE OF PHILIPS I ² C COMPONENTS

Digital PC-camera signal processor

SAA8113HL



1 FEATURES

- High precision digital processing with 10-bit input
- Medium resolution complementary mosaic CCD sensors PAL or NTSC (interlaced mode only)
- Internal PPG, dedicated to SHARP, TOSHIBA and PANASONIC sensors
- Integrated microcontroller (80C51) for control loops Auto Optical Black (AOB), Auto White Balance (AWB) and Auto Exposure (AE)
- Black offset preprocessing
- RGB separation
- RGB processing (colour correction matrix, programmable knee and gamma)
- Separate Y-processing (saturation concealment, programmable knee and gamma)
- RGB to UV conversion (including down-sampling filters)
- Noise reduction in Y and UV
- Display function for system evaluation
- Analog output processing, including PAL/NTSC encoder and 9-bit Video Digital-to-Analog Converter (VDAC)
- Measurement engine (prepared for AE and AWB features)
- Miscellaneous functions, e.g. power management, 7-bit Control DAC (CDAC) serial interface with preprocessing
- VH reference and window timing for internal use
- Master I²C-bus interface for communication with an external EEPROM (containing the default settings)
- Slave I²C-bus interface for communication with an external microcontroller
- Parallel interface for communication with an external EPROM (for ROM code debugging)
- Integrated audio amplifier.

2 APPLICATIONS

- Low-cost desktop video applications
- Videophone systems.

4 ORDERING INFORMATION

TYPE NUMBER	PACKAGE		
	NAME	DESCRIPTION	VERSION
SAA8113HL	LQFP100	plastic low profile quad flat package; 100 leads; body 14 × 14 × 1.4 mm	SOT407-1

3 GENERAL DESCRIPTION

The SAA8113HL is a 2nd generation camera Digital Signal Processor (DSP) designed for low-cost DTV applications. It integrates the DSP core, the Pulse Pattern Generator (PPG), the 80C51 microcontroller and the VDAC in one IC. It is the successor of the SAA8110G, dedicated to analog output cameras.

The SAA8113HL must be applied together with an analog front-end that includes a Correlated Double Sampling (CDS), an Automatic Gain Control (AGC) and an Analog-to-Digital Converter (ADC). This may be the TDA8786 or the TDA8784.

The PPG generates the timing pulses to drive medium resolution PAL/NTSC complementary mosaic CCD sensors (512 × 492 NTSC and 512 × 582 PAL).

The input of the DSP is 10 bits with a maximum pixel frequency equal to 9.66 MHz. The DSP core processes this sensor signal to a standard video output signal. The SAA8113HL output is an analog CVBS video signal.

The microcontroller provides the settings for the IC registers from EEPROM at power-up or reset and controls the AWB, AE and AOB loops. It also provides a hardware I²C-bus interface, so the microcontroller can be used as an I²C-bus slave. The software code is embedded in an internal ROM but it is also possible to use a combined data and address bus, connected to an external program EPROM.

A built-in power management function allows the power dissipation to be optimized.

Digital PC-camera signal processor

SAA8113HL

5 QUICK REFERENCE DATA

Measured over full voltage and temperature range.

SYMBOL	PARAMETER	CONDITIONS	MIN.	TYP.	MAX.	UNIT
V_{DDD}	digital supply voltage		3.0	3.3	3.6	V
V_{DDA}	analog supply voltage		3.0	3.3	3.6	V
$I_{DD(tot)}$	total supply current	$V_{DDD} = 3.3\text{ V}$	–	60	–	mA
V_I	input voltage	$3.0\text{ V} < V_{DDD} < 3.6\text{ V}$	low-voltage TTL compatible			V
		note 1	5 V tolerant, TTL compatible			V
V_O	output voltage	$3.0\text{ V} < V_{DDD} < 3.6\text{ V}$	low-voltage TTL compatible			V
		note 1	5 V tolerant, TTL compatible			V
f_{clk}	clock frequency input		–	38	–	MHz
δ	duty factor of f_{clk}		–	50	–	%
P_{tot}	total power dissipation	$T_{amb} = 25\text{ }^\circ\text{C}$	–	200	250	mW
T_{stg}	storage temperature		–55	–	+150	$^\circ\text{C}$
T_{amb}	ambient temperature		0	25	70	$^\circ\text{C}$
T_j	junction temperature	$T_{amb} = 70\text{ }^\circ\text{C}$	–40	–	+125	$^\circ\text{C}$

Note

1. This concerns pins SCL and SDA.

Digital PC-camera signal processor

SAA8113HL

6 BLOCK DIAGRAM

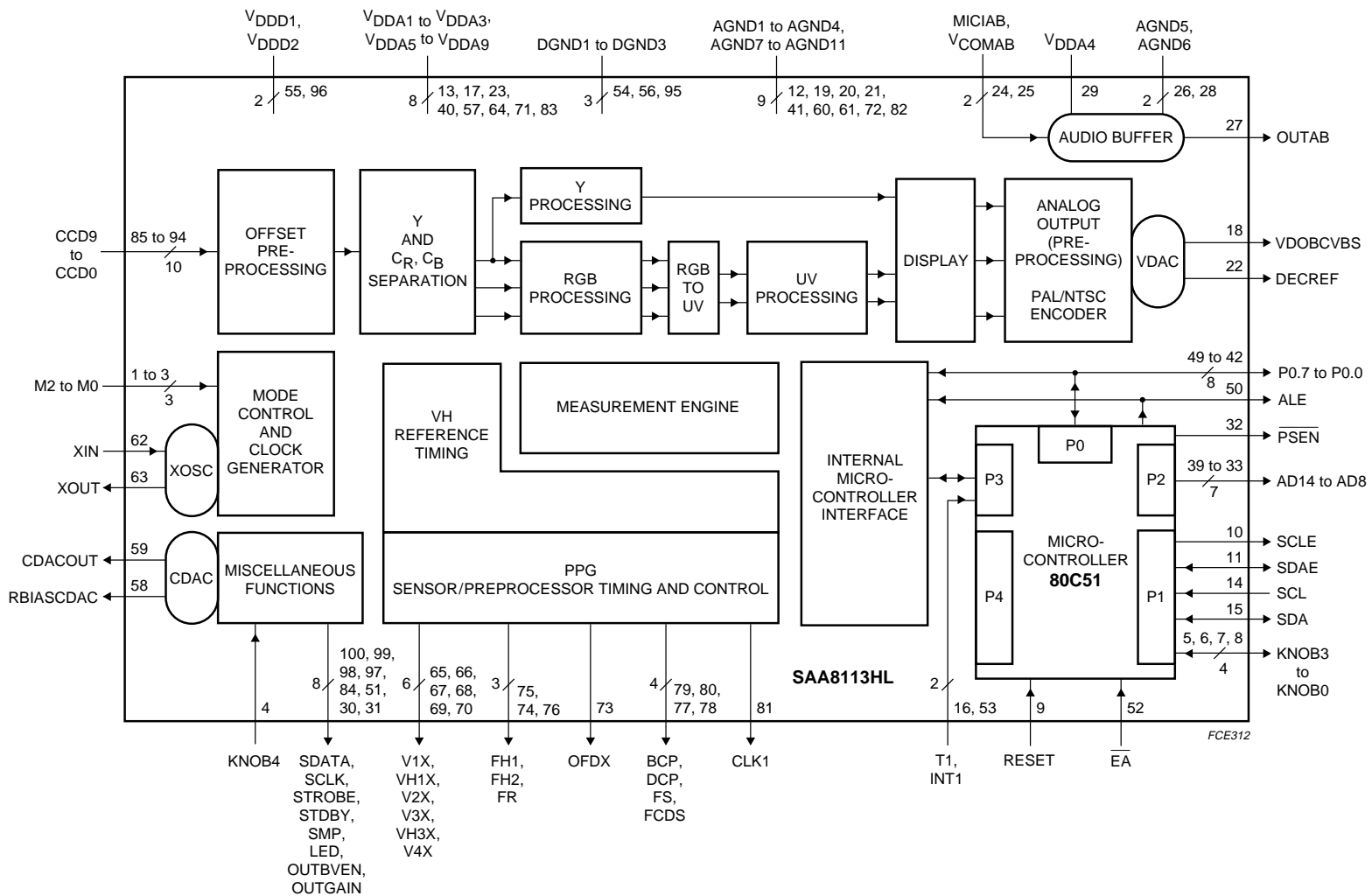

Fig.1 Block diagram.

Digital PC-camera signal processor

SAA8113HL

7 PINNING

SYMBOL	PIN	I/O	DESCRIPTION
M2	1	I	test mode control signal bit 2
M1	2	I	test mode control signal bit 1
M0	3	I	test mode control signal bit 0
KNOB4	4	I	input connected to DSP core
KNOB3	5	I/O	I/O connected to internal 80C51
KNOB2	6	I/O	I/O connected to internal 80C51
KNOB1	7	I/O	I/O connected to internal 80C51
KNOB0	8	I/O	I/O connected to internal 80C51
RESET	9	I	Power-on reset
SCLE	10	O	master I ² C-bus clock output to control EEPROM
SDAE	11	I/O	master I ² C-bus data I/O to control EEPROM
AGND1	12	I	analog ground 1 for output buffers
V _{DDA1}	13	I	analog supply voltage 1 for output buffers
SCL	14	I	slave I ² C-bus clock input
SDA	15	I/O	slave I ² C-bus data I/O
T1	16	I	Timer 1 for internal 80C51
V _{DDA2}	17	I	analog supply voltage 2 for DAC output buffer
VDOBCVBS	18	O	VDAC output buffer for CVBS signal
AGND2	19	I	analog ground 2 for DAC output buffer
AGND3	20	I	analog ground 3 for analog DAC core and band gap (connected to substrate)
AGND4	21	I	analog ground 4 for analog DAC core and band gap (not connected to substrate)
DECREF	22	O	decoupled pin for reference voltage HIGH
V _{DDA3}	23	I	analog supply voltage 3 for analog DAC core and band gap
MICIAB	24	I	microphone input audio buffer
V _{COMAB}	25	I	common voltage for audio buffer
AGND5	26	I	analog ground 5 for audio buffer (not connected to substrate)
OUTAB	27	O	output audio buffer
AGND6	28	I	analog ground 6 for audio buffer (connected to substrate)
V _{DDA4}	29	I	analog supply voltage 4 for audio buffer
OUTBVEN	30	O	output to enable the bias voltage of the microphone for the audio buffer
OUTGAIN	31	O	output to control the gain factor of an external audio buffer
$\overline{\text{PSEN}}$	32	O	program store enable; read strobe for external program memory (active LOW)
AD8	33	O	address bit 8 for external program memory (PROM)
AD9	34	O	address bit 9 for external program memory (PROM)
AD10	35	O	address bit 10 for external program memory (PROM)
AD11	36	O	address bit 11 for external program memory (PROM)
AD12	37	O	address bit 12 for external program memory (PROM)
AD13	38	O	address bit 13 for external program memory (PROM)
AD14	39	O	address bit 14 for external program memory (PROM)
V _{DDA5}	40	I	analog supply voltage 5 for output buffers

Digital PC-camera signal processor

SAA8113HL

SYMBOL	PIN	I/O	DESCRIPTION
AGND7	41	I	analog ground 7 for output buffers
P0.0	42	I/O	port 0 bidirectional bit 0 for external program memory data I/O (PROM)
P0.1	43	I/O	port 0 bidirectional bit 1 for external program memory data I/O (PROM)
P0.2	44	I/O	port 0 bidirectional bit 2 for external program memory data I/O (PROM)
P0.3	45	I/O	port 0 bidirectional bit 3 for external program memory data I/O (PROM)
P0.4	46	I/O	port 0 bidirectional bit 4 for external program memory data I/O (PROM)
P0.5	47	I/O	port 0 bidirectional bit 5 for external program memory data I/O (PROM)
P0.6	48	I/O	port 0 bidirectional bit 6 for external program memory data I/O (PROM)
P0.7	49	I/O	port 0 bidirectional bit 7 for external program memory data I/O (PROM)
ALE	50	O	address latch enable pulse for external latch
LED	51	O	output to drive LED
$\bar{E}A$	52	I	external access select bit for internal 80C51 (active LOW)
INT1	53	I	interrupt 1 for internal 80C51
DGND1	54	I	digital ground 1 for input buffers, predrivers and the digital core
V_{DD1}	55	I	digital supply voltage 1 for input buffers, predrivers and the digital core
DGND2	56	I	digital ground 2 for input buffers, predrivers and the digital core
V_{DDA6}	57	I	analog supply voltage 6 for CDAC
RBIASCDAC	58	O	bias resistor for CDAC
CDACOUT	59	O	output CDAC
AGND8	60	I	analog ground 8 for CDAC
AGND9	61	I	analog ground 9 for 38 MHz (fundamental) crystal oscillator
XIN	62	I	oscillator input
XOUT	63	O	oscillator output
V_{DDA7}	64	I	analog supply voltage 7 for 38 MHz (fundamental) crystal oscillator
V1X	65	O	vertical CCD transfer pulse 1X
VH1X	66	O	vertical CCD load pulse H1X
V2X	67	O	vertical CCD transfer pulse 2X
V3X	68	O	vertical CCD transfer pulse 3X
VH3X	69	O	vertical CCD load pulse H3X
V4X	70	O	vertical CCD transfer pulse 4X
V_{DDA8}	71	I	analog supply voltage 8 for output buffers
AGND10	72	I	analog ground 10 for output buffers
OFDX	73	O	overflow drain pulse for shutter control
FH2	74	O	horizontal CCD transfer pulse F2
FH1	75	O	horizontal CCD transfer pulse F1
FR	76	O	CCD output amplifier reset pulse (TDA8786 or TDA8784)
FS	77	O	CCD output level sample and hold pulse (TDA8786 or TDA8784)
FCDS	78	O	reference level sample and hold pulse (TDA8786 or TDA8784)
BCP	79	O	black pixel clamp pulse (TDA8786 or TDA8784)
DCP	80	O	dummy pixel clamp pulse (TDA8786 or TDA8784)
CLK1	81	O	pixel clock to preprocessor (TDA8786 or TDA8784)

Digital PC-camera signal processor

SAA8113HL

SYMBOL	PIN	I/O	DESCRIPTION
AGND11	82	I	analog ground 11 for output buffers
V _D DA9	83	I	analog supply voltage 9 for output buffers
SMP	84	O	switch mode pulse for DC-to-DC power supply
CCD9	85	I	(preprocessed) AD-converted CCD signal bit 9
CCD8	86	I	(preprocessed) AD-converted CCD signal bit 8
CCD7	87	I	(preprocessed) AD-converted CCD signal bit 7
CCD6	88	I	(preprocessed) AD-converted CCD signal bit 6
CCD5	89	I	(preprocessed) AD-converted CCD signal bit 5
CCD4	90	I	(preprocessed) AD-converted CCD signal bit 4
CCD3	91	I	(preprocessed) AD-converted CCD signal bit 3
CCD2	92	I	(preprocessed) AD-converted CCD signal bit 2
CCD1	93	I	(preprocessed) AD-converted CCD signal bit 1
CCD0	94	I	(preprocessed) AD-converted CCD signal bit 0
DGND3	95	I	digital ground 3 for input buffers, predrivers and the digital core
V _D DD2	96	I	digital supply voltage 2 for input buffers, predrivers and the digital core
STDBY	97	O	standby control output to TDA8786 or TDA8784
STROBE	98	O	strobe to TDA8786 or TDA8784
SCLK	99	O	serial clock to TDA8786 or TDA8784
SDATA	100	O	serial data to TDA8786 or TDA8784

Digital PC-camera signal processor

SAA8113HL

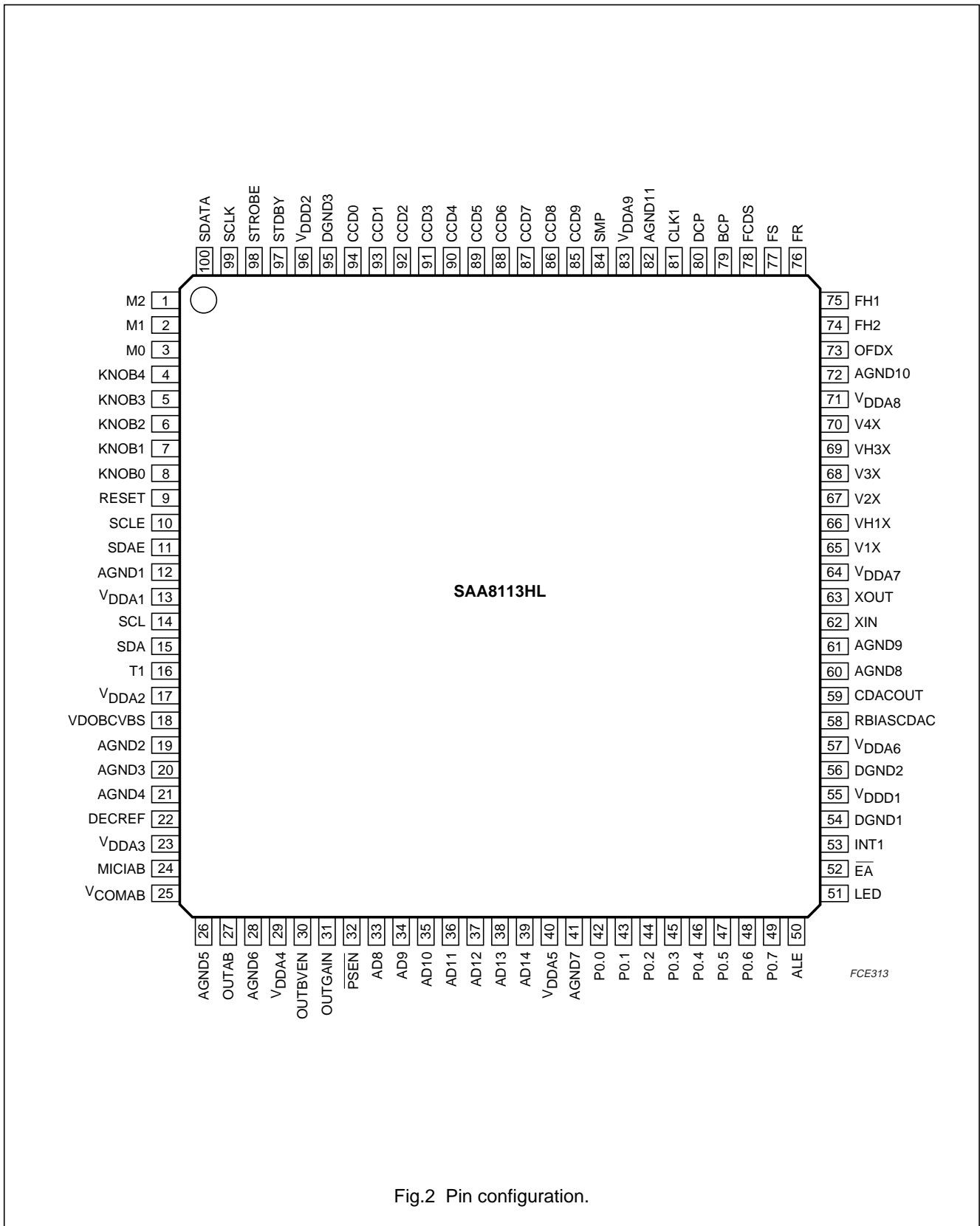

Fig.2 Pin configuration.

Digital PC-camera signal processor

SAA8113HL

8 FUNCTIONAL DESCRIPTION**8.1 Black offset preprocessing**

The CCD signal contains additional pixels outside the active window, which are used to measure the reference black level. These pixels are located in the optical black window, whose position can be set through the serial interface. The optical black level can be adjusted by the microcontroller in order to proceed rapidly. In this case, the microcontroller directly adjusts the analog preprocessing clamp included in the TDA8786 or TDA8784 and takes

advantage of the full code range. Otherwise, the black level is fixed by settings that are downloaded through the serial interface.

8.2 Y, C_R and C_B separation

For each pixel value, this block (see Fig.3) generates the three components: the luminance signal Y and the two colour signals C_R (2R – G) and C_B (2B – G). Two line memories are required for this function. This block also provides vertical contour and white clip information.

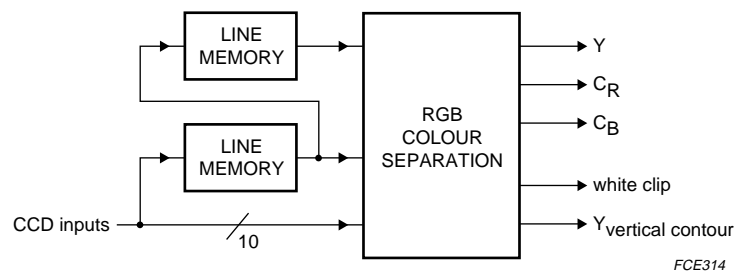

Fig.3 Y, C_R and C_B separation diagram.

Digital PC-camera signal processor

SAA8113HL

8.3 RGB processing

The RGB processing (see Fig.4) includes several features:

- Colour space matrix to handle different types of colour sensors. The result is an optimum colour reproduction through the minimization of colour errors. The default matrix coefficients (positive or negative) can be adjusted through an external interface.
- Separate and adjustable black offsets for R, G and B signals.
- Separate gain controls for R and B signals dedicated to white balance control. The colour temperature can be adjusted independently of the colour matrix.
- Knee function (compression factor and knee point are adjustable).
- Adjustable gamma function to compensate for the non-linearity of display devices.

The RGB path has a reduced bandwidth (less than 1 MHz), which is required for CVBS output.

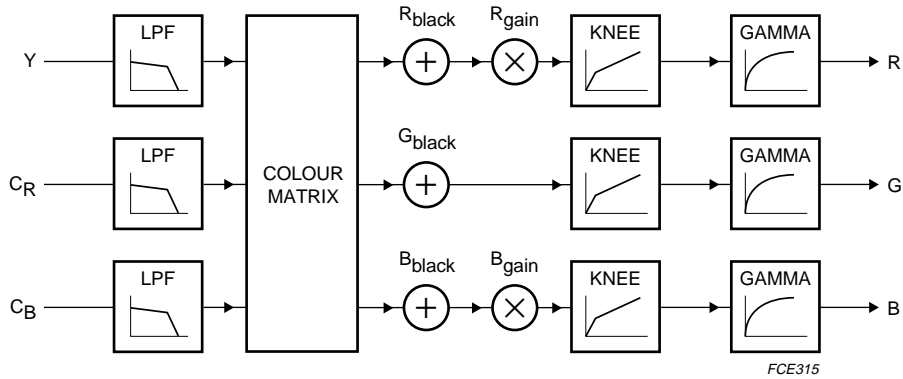

Fig.4 RGB processing diagram.

Digital PC-camera signal processor

SAA8113HL

8.4 Y processing

The separate Y processing (see Fig.5) includes the following features:

- Saturation concealment to reduce the typical saturation distortion
- Contour processing to improve picture sharpness
- Noise reduction
- Black offset
- Pre-gain control to adjust the Y signal with respect to the gamma range
- Knee function (compression factor and knee point are adjustable)
- Adjustable gamma function
- Gain control.

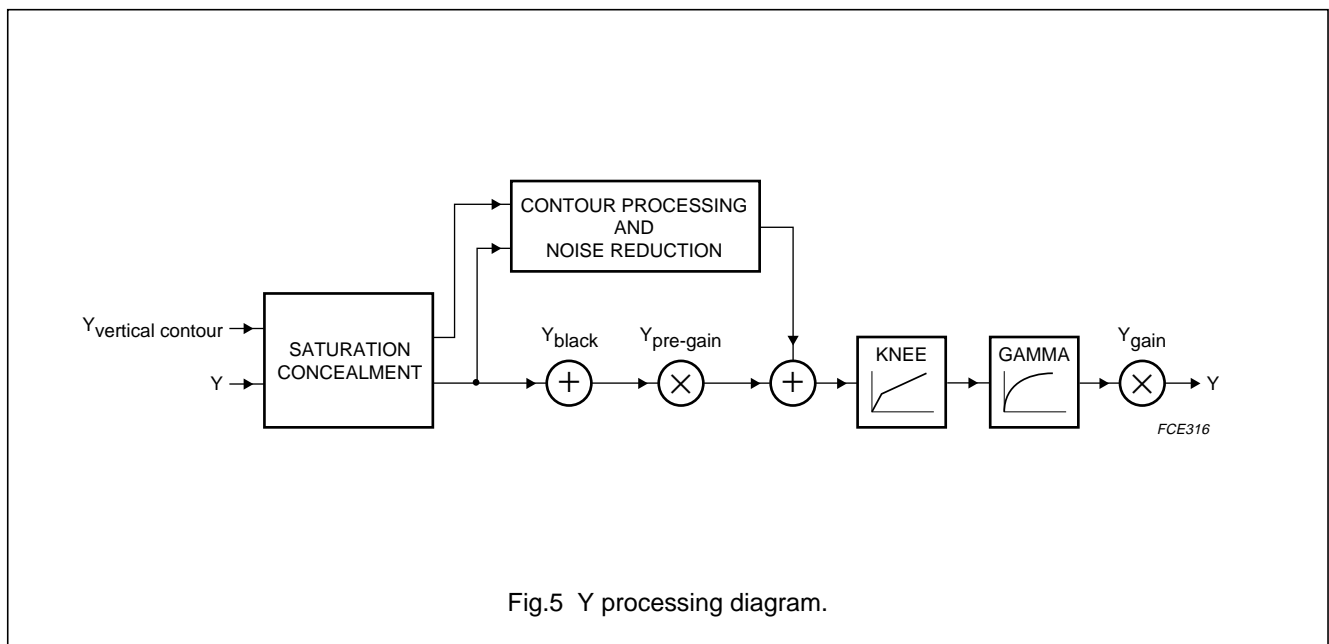
**8.5 RGB to UV conversion**

After R, G and B processing, the data path is converted to U and V signals (see Fig.1). As a result of the reduced bandwidth, the Y signal is only used as an input for control loop purposes (measurement engine).

8.6 UV processing

The chrominance processing consists of a noise reduction by coring and the UV gain control.

8.7 Display function

As an optional feature and for software debugging, it is possible to visualize:

- Eight display bars (assigned via the microcontroller)
- Several measurement engine inputs.

Digital PC-camera signal processor

SAA8113HL

8.8 Analog output processing

The analog output processing (see Fig.6) contains a PAL/NTSC encoder to transform the YUV data path to the CVBS output. The YUV input signals are up-sampled to

twice the pixel clock and digitally prefiltered to keep the external analog filter simple. The block also contains an adjustable luminance clipper.

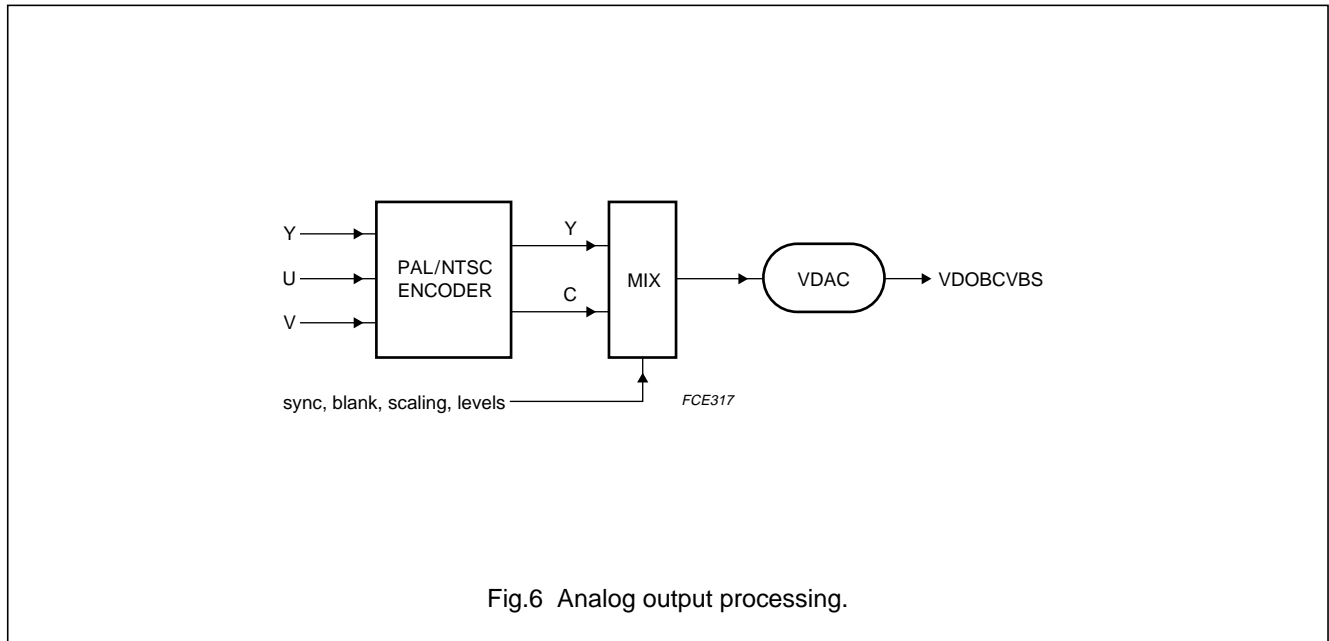

Fig.6 Analog output processing.

8.9 Measurement engine

The measurement engine performs data measurements on a field basis to get inputs for the AE and AWB control loops of the microcontroller. Up to 16 programmable windows can be used for the measurement. There are two down-samplers to prepare the data for two separate accumulators. It is possible to proceed with eight different measurements per field (odd and even fields separately). An internal RAM workspace is used for data handling operation.

8.10 VH reference and window timing and control

This block generates internal control signals for different purposes:

- Vertical, horizontal and field references (V_D , H_D and F_I) for PAL or NTSC sensors
- Specification of the active window and the optical black window
- Specification of the measurement window grid with respect to the active window
- Specification of the vertical position of the display bars, see Section 8.7.

All these specifications can be controlled through the serial interface.

Digital PC-camera signal processor

SAA8113HL

8.11 Pulse pattern generator

The PPG generates timing pulses (Figs. 7 to 10) for driving the CCD sensor (including the vertical driver) and pulses for the preprocessor TDA8786 or TDA8784 (correlated double sampling and black clamping).

The PPG is dedicated to the medium resolution sensors with complementary mosaic colour filters (512 × 492 NTSC and 512 × 582 PAL) described in Table 1. Figs. 11 and 12 show the PPG outputs.

Table 1 Medium resolution CCD sensors driven by the internal PPG; note 1

BRAND	FORMAT	TYPE
SHARP	PAL 1/4"	LZ2423A
	NTSC 1/4"	LZ2413A
	PAL 1/5"	LZ2523
	NTSC 1/5"	LZ2513
TOSHIBA	PAL 1/4"	TCD5391AP
	NTSC 1/4"	TCD5381AP
SHARP low voltage	PAL 1/4"	LZ2425
	NTSC 1/4"	LZ2415
PANASONIC	PAL 1/4"	MN37210FP
	PAL 1/4"	MN37201FP
	NTSC 1/4"	MN37110FP
	NTSC 1/4"	MN37101FP

Note

1. All sensors are used with the vertical driver: NEC μ PD16510.

The PPG includes special features:

- A charge reset is possible in every active line during the horizontal line blanking and multiple times during the vertical blanking
- A fast shutter interface is available.

Digital PC-camera signal processor

SAA8113HL

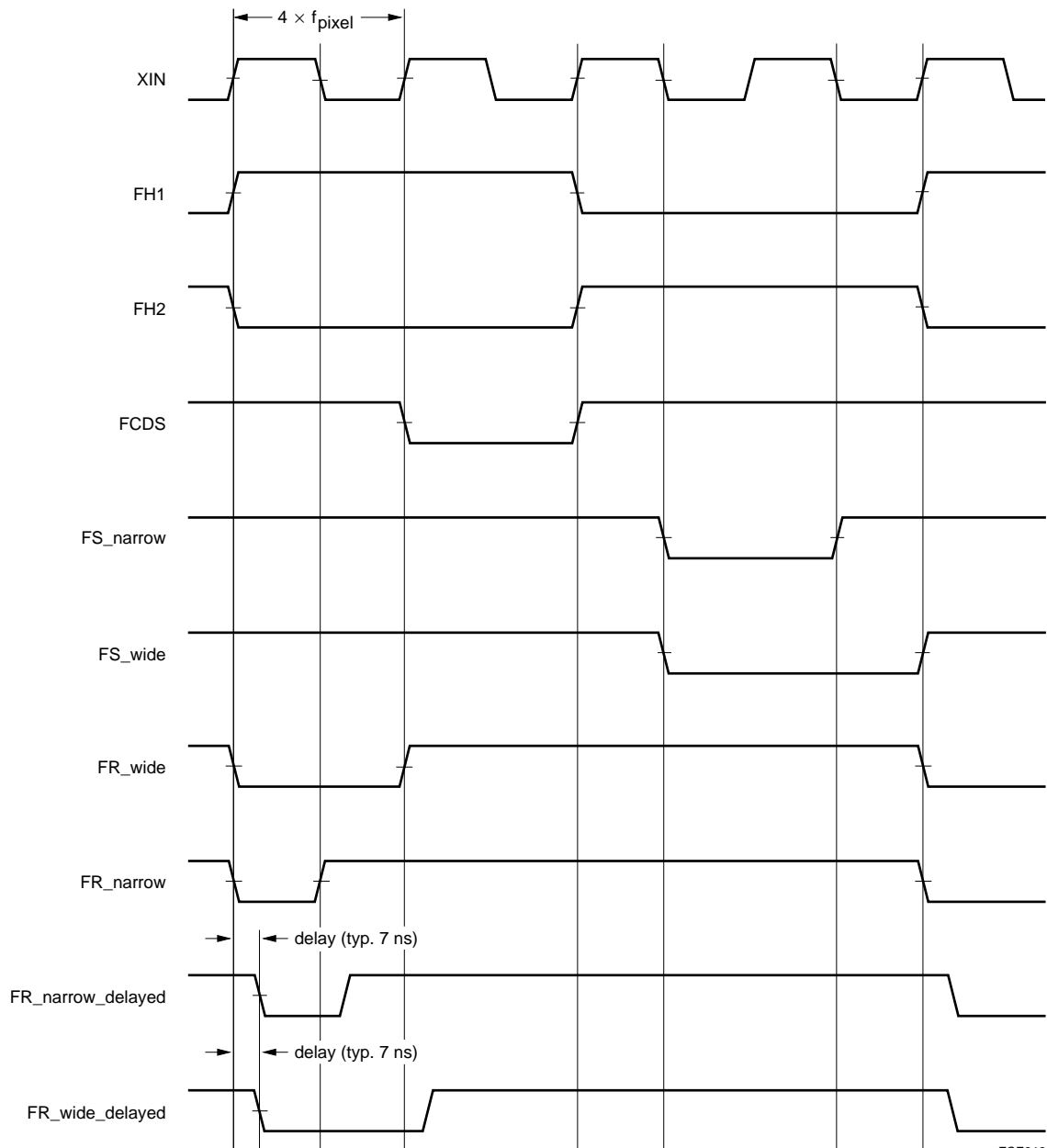

FCE318

Fig.7 High speed pulse timing (CCD sensor and preprocessor).

Digital PC-camera signal processor

SAA8113HL

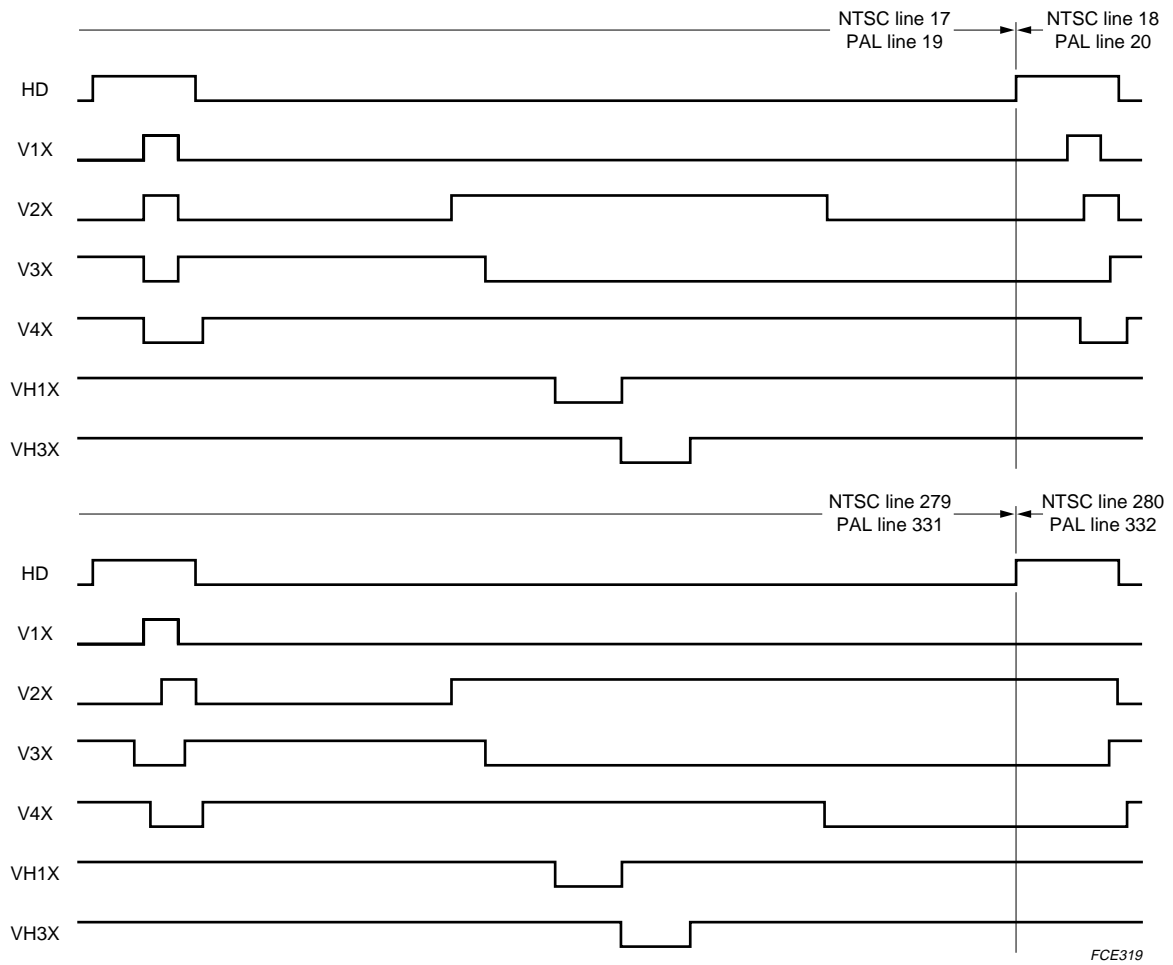
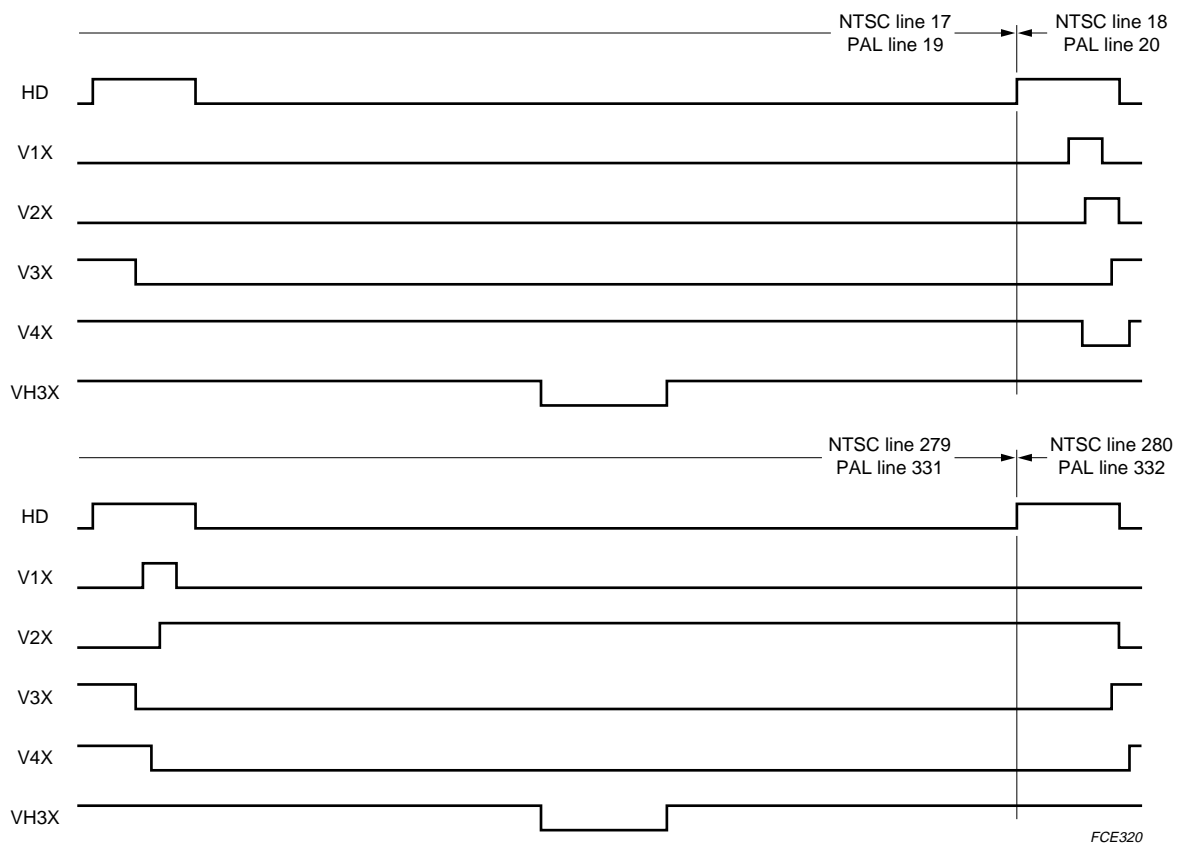

Fig.8 SHARP and TOSHIBA CCD sensors/vertical drivers.

Digital PC-camera signal processor

SAA8113HL



FCE320

Fig.9 SHARP low-voltage CCD sensors/vertical drivers.

Digital PC-camera signal processor

SAA8113HL

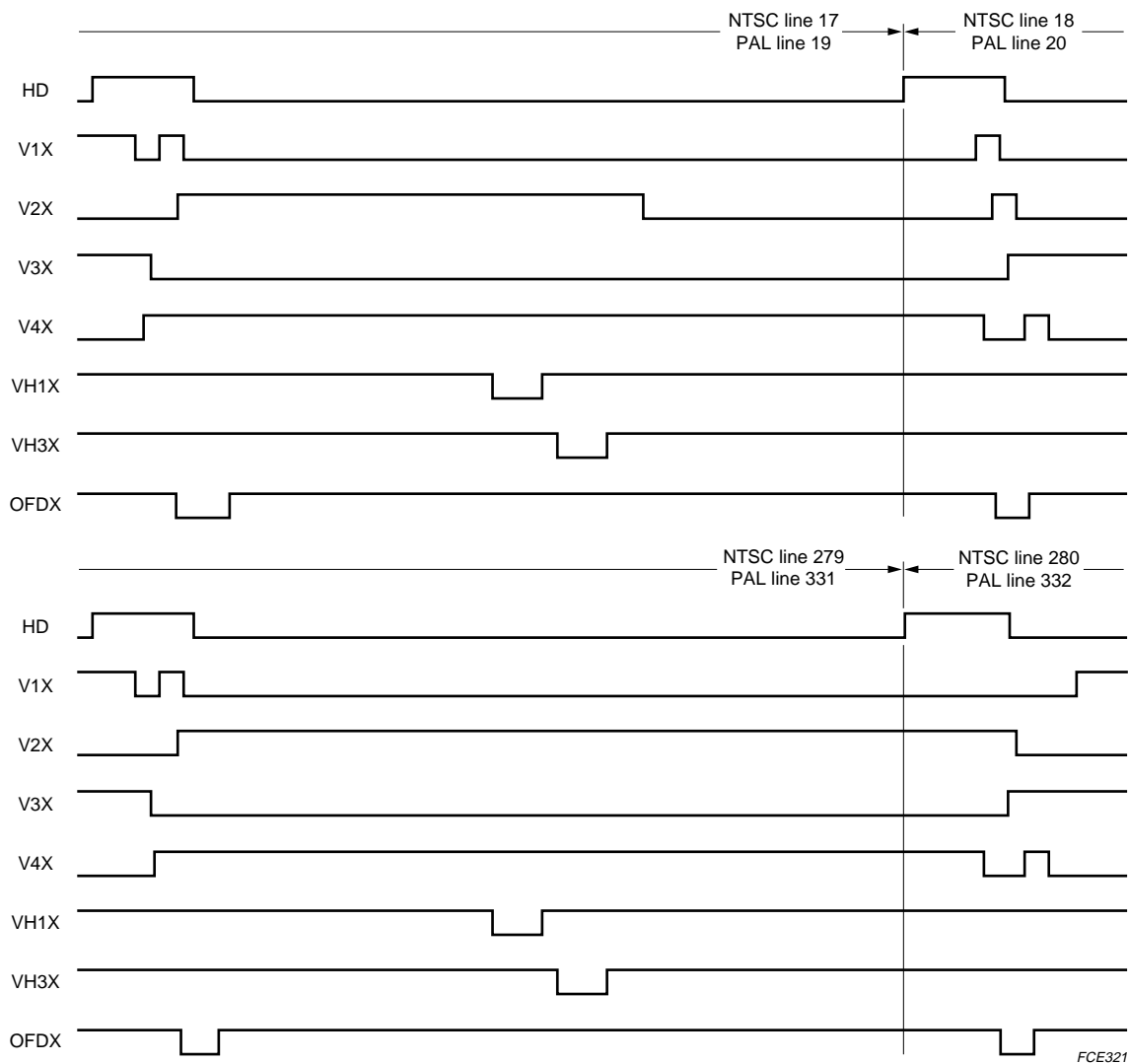

FCE321

Fig.10 PANASONIC CCD sensors/vertical drivers.

Digital PC-camera signal processor

SAA8113HL

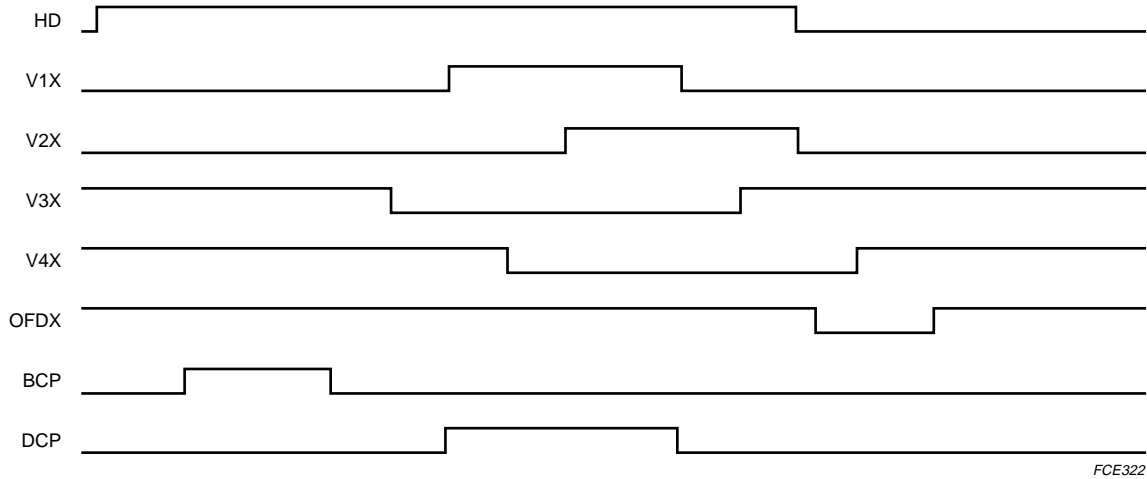

Fig.11 SHARP, all types, PPG output.

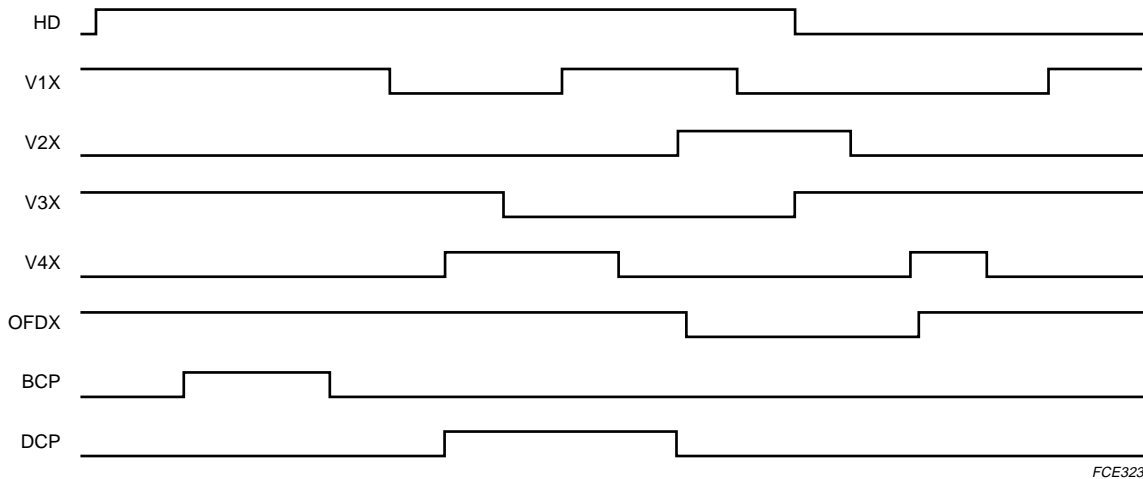

Fig.12 PANASONIC PPG output.

Digital PC-camera signal processor

SAA8113HL

8.12 Miscellaneous functions

- Power consumption: it is possible to switch the DSP off without switching off the microcontroller.
- Oscillator frequency: a 7-bit CDAC tunes the oscillator frequency according to the external quartz frequency to guarantee the typical value of 38 MHz.

The control digital value is downloaded through the serial interface.

- A 3-wire serial bus transfers the settings from the microcontroller to the preprocessor (TDA8786 or TDA8784).

8.13 Mode control

This block controls the operational modes of the SAA8113HL: application or test modes, see Table 2. For a smooth adaptability, it is possible to bypass the main modules.

Table 2 Mode control

M2	M1	M0	EA	MODE
0	0	0	\overline{EA} ; note 1	application mode
0	0	1	–	application mode with bypassed PPG
0	1	0	–	application mode with bypassed microcontroller
0	1	1	0	application mode with bypassed PPG and microcontroller

Note

1. \overline{EA} can be high or low, according to the application (high is for internal ROM access, low for external access).

8.14 Microcontroller

The embedded microcontroller is basically an 80C654 core (80C51 family) with four ports. Its functionality is standard, except that the core has no clock divided by 2 and the ports are dedicated input, output or I/O ports. Ports P0 and P2 are available for connection to a debugger or to an external program EPROM. The microcontroller controls the AOB, the AE and the AWB loops and downloads the settings for the DSP registers from EEPROM at power-up or reset. Table 3 lists the 80C51 Standard Function Registers.

The microcontroller includes the following features:

- 16 kbyte internal ROM
- 256 byte RAM
- Hardware I²C-bus interface for communication with external microcontroller: SDA and SCL
- Software I²C-bus interface for communication with external EEPROM containing DSP settings: SDAE and SCLE
- Four I/O pins which can be used as human interface (knobs): P1.0, P1.1, P1.2 and P1.3.

Digital PC-camera signal processor

SAA8113HL

Table 3 80C51 Standard Function Registers

SFR NAME	DESCRIPTION	SFR ADDRESS	DATA BIT 7	DATA BIT 6	DATA BIT 5	DATA BIT 4	DATA BIT 3	DATA BIT 2	DATA BIT 1	DATA BIT 0
B	B register	F0H	B7	B6	B5	B4	B3	B2	B1	B0
ACC	accumulator	E0H	ACC7	ACC6	ACC5	ACC4	ACC3	ACC2	ACC1	ACC0
SIADR	serial interface address	DBH	SA6	SA5	SA4	SA3	SA2	SA1	SA0	GC
SIDAT	serial interface data	DAH	SD7	SD6	SD5	SD4	SD3	SD2	SD1	SD0
SISTA	serial interface status	D9H	ST7	ST6	ST5	ST4	ST3	0	0	0
SICON	serial interface control	D8H	CR2	ENS1	STA	STO	SI	AA	CR1	CR0
PSW	program status word	D0H	CY	AC	F0	RS1	RS0	OV	–	P
P4	port 4	C7H	–	–	–	–	–	–	–	STBY
IP	interrupt priority	B8H	–	IP6	IP5	IP4	PT1	PX1	PT0	PX0
P3	port 3	B0H	RDN	WRN	T1	T0	INT1	INT0	FI	CRST
IE	interrupt enable	A8H	EA	IE6	IE5	IE4	ET1	EX1	ET0	EX0
P2	port 2	A0H	AD15	AD14	AD13	AD12	AD11	AD10	AD9	AD8
P1	port 1	90H	SDA	SCL	SDAE	SCLE	P1.3	P1.2	P1.1	P1.0
TH1	timer HIGH 1	8DH	–	–	–	–	–	–	–	–
TH0	timer HIGH 0	8CH	–	–	–	–	–	–	–	–
TL1	timer LOW 1	8BH	–	–	–	–	–	–	–	–
TL0	timer LOW 0	8AH	–	–	–	–	–	–	–	–
TMOD	timer mode	89H	GATE	C/T	M1	M0	Gate	C/T	M1	M0
TCON	timer control	88H	TF1	TR1	TF0	TR0	IE1	IT1	IE0	IT0
PCON	power control	87H	–	–	–	–	–	–	PD	IDL
DPH	data pointer HIGH	83H	–	–	–	–	–	–	–	–
DPL	data pointer LOW	82H	–	–	–	–	–	–	–	–
SP	stack pointer	81H	SP7	SP6	SP5	SP4	SP3	SP2	SP1	SP0
P0	port 0	80H	AD7	AD6	AD5	AD4	AD3	AD2	AD1	AD0

8.15 Audio amplifier

An analog audio amplifier is integrated in the SAA8113HL. Its gain can be adjusted between a high (45 dB typical) and a low (13 dB typical) value through the serial interface.

8.16 I²C-bus interface

Table 4 gives the command list of the I²C-bus interface.

Digital PC-camera signal processor

SAA8113HL

Table 4 Command list

ADD	NAME	FUNCTION	FORMAT	RANGE
0	CONTROL0	see Table 5 for explanation	byte	n.a.
1	CONTROL1	see Table 7 for explanation	byte	n.a.
2	CONTROL2	see Table 8 for explanation	byte	n.a.
3	OB_STARTL_F0	first line optical black window in field 0	byte	[0 to 255]
4	OB_STARTL_F1	first line optical black window in field 1	byte	256 + [0 to 255]
5	OB_STARTP	first pixel optical black window	byte	[0 to 255]
6	OB_PE_F0	fixed optical black level for even pixel in field 0	byte	[0 to 127]
7	OB_PO_F0	fixed optical black level for odd pixel in field 0	byte	[0 to 127]
8	OB_PE_F1	fixed optical black level for even pixel in field 1	byte	[0 to 127]
9	OB_PO_F1	fixed optical black level for odd pixel in field 1	byte	[0 to 127]
10	COL_MAT_P11	colour matrix coefficient p11	byte	[-128 to 127]/16
11	COL_MAT_P12	colour matrix coefficient p12	byte	[-128 to 127]/16
12	COL_MAT_P13	colour matrix coefficient p13	byte	[-128 to 127]/16
13	COL_MAT_P21	colour matrix coefficient p21	byte	[-128 to 127]/16
14	COL_MAT_P22	colour matrix coefficient p22	byte	[-128 to 127]/16
15	COL_MAT_P23	colour matrix coefficient p23	byte	[-128 to 127]/16
16	COL_MAT_P31	colour matrix coefficient p31	byte	[-128 to 127]/16
17	COL_MAT_P32	colour matrix coefficient p32	byte	[-128 to 127]/16
18	COL_MAT_P33	colour matrix coefficient p33	byte	[-128 to 127]/16
19	R_BLACK	fixed R-black level offset	byte	[-128 to 127]
20	G_BLACK	fixed G-black level offset	byte	[-128 to 127]
21	B_BLACK	fixed B-black level offset	byte	[-128 to 127]
22	COL_MAT_RGAIN	colour matrix R-gain factor	byte	[0 to 255]/128
23	COL_MAT_BGAIN	colour matrix B-gain factor	byte	[0 to 255]/64
24	THR_LUM	threshold luminance for fader	byte	[0 to 255]
25	THR_COLOR	threshold colour for fader	byte	[0 to 255]
26	Y_BLACK	fixed Y-black level offset	byte	[-128 to 127]
27	K1	gain correction for Y path	byte	[0 to 255]/128
28	RGB_KNEE_OFFSET	offset for RGB knee	byte	[0 to 255]
29	Y_KNEE_OFFSET	offset for Y knee	byte	[0 to 255]
30	RGB_GAMMA_BALANCE	gamma multiplication factor (for RGB data path)	6 bits	[0 to 63]/64
31	Y_GAMMA_BALANCE	gamma multiplication factor (for Y data path)	6 bits	[0 to 63]/64
32	KCOMB	vertical contour comb filter coefficient (MS)	4 bits	[0 to 7]/8
	VCGAIN	vertical contour gain (LS)	4 bits	[0 to 15]/16
33	CLDLEV	contour level dependency level	byte	[0 to 255]/2
34	HCLGAIN	horizontal contour BPF low gain (LS)	4 bits	[0 to 15]/16
	HCHGAIN	horizontal contour BPF high gain (MS)	4 bits	[0 to 15]/16
35	CNCLEV	contour noise coring level	6 bits	[0 to 63]
36	CONGAIN	contour gain factor; see Table 9	2 bits	[0 to 63]/16
37	VU_VALUE 1	length of VU_Bar 1	byte	2 × [0 to 255]

Digital PC-camera signal processor

SAA8113HL

ADD	NAME	FUNCTION	FORMAT	RANGE
38	VU_VALUE 2	length of VU_Bar 2	byte	2 × [0 to 255]
39	VU_VALUE 3	length of VU_Bar 3	byte	2 × [0 to 255]
40	VU_VALUE 4	length of VU_Bar 4	byte	2 × [0 to 255]
41	VU_VALUE 5	length of VU_Bar 5	byte	2 × [0 to 255]
42	VU_VALUE 6	length of VU_Bar 6	byte	2 × [0 to 255]
43	VU_VALUE 7	length of VU_Bar 7	byte	2 × [0 to 255]
44	VU_VALUE 8	length of VU_Bar 8	byte	2 × [0 to 255]
45	Y_DISPLAY_OFFSET	display offset (to be used with D_Contour)	byte	4 × [0 to 255]
46	UNCLEV	U (chrominance) noise coring level	byte	[0 to 255]/4
47	VNCLEV	V (chrominance) noise coring level	byte	[0 to 255]/4
48	YGAIN	Y (luminance) gain factor	byte	[0 to 255]/128
49	UGAIN	U (B-Y) gain factor	byte	[0 to 255]/128
50	VGAIN	V (R-Y) gain factor	byte	[0 to 255]/128
51	CTR_UPD_LINE	number of line for DB-update control registers	byte	[0 to 255]
52	BURST_LEVEL	burst level colour burst	byte	[0 to 255]
53	A	AWB_A (Measurement Engine)	byte	[-128 to 127]/128
54	B	AWB_B (Measurement Engine)	byte	[-128 to 127]/128
55	C	AWB_C (Measurement Engine)	byte	[-128 to 127]/128
56	D	AWB_D (Measurement Engine)	byte	[-128 to 127]/128
57	E	AWB_E (Measurement Engine)	6 bits	[0 to 63]
58	F	AWB_F (Measurement Engine)	6 bits	[0 to 63]
59	HIGHLIGHTTHR	highlight threshold (Measurement Engine)	byte	[0 to 255]
60	ME_RESSCALE	ME sync + ME result scale (ME); see Table 10	4 bits	n.a.
61	DISP_CNTRL	control bits for display function; see Table 11	byte	n.a.
62	YDISPLEV	luminance display level in display function	byte	[0 to 255]
63	DMWSEL	display measurement window select; see Table 13	byte	n.a.
64	ANA_WHITECLIP	white clip limiter level for analog outputs	byte	256 + [0 to 255]
65	PRE_SI_LSB	control data for analog processing	byte	[0 to 255]
66	PRE_SI_MSB	control data and address for analog processing; see Table 14	5 bits	[0 to 63]
67	SMP_CNTRL	control for switch mode power supply	byte	[0 to 255]
68	CDAC_DATA	CDAC data (7-bit); see Table 15	7 bits	[0 to 127]
69	BLANKLEV	blanking level in analog output	byte	[0 to 255]
70	BL-SETUP	setup level in analog output	byte	[0 to 255]
71	PRE_PROC_DEL	control compensation delay w.r.t. preprocessing	4 bits	[0 to 15]
72	BCP_START	B clamp pulse start	byte	[0 to 255]
73	BCP_STOP	B clamp pulse stop	byte	[0 to 255]
74	DCP_START	D clamp pulse start	byte	[0 to 255]
75	DCP_STOP	D clamp pulse stop	byte	[0 to 255]
76	EE_CONTROL_LSB	E Exposure LSB	byte	[0 to 255]

Digital PC-camera signal processor

SAA8113HL

ADD	NAME	FUNCTION	FORMAT	RANGE
77	EE_CONTROL_MSB	E Exposure MSB	byte	[0 to 255]
78	MISC_CONTROL	miscellaneous control bits; see Table 16	5 bits	[0 to 31]
79	FPIX_ACT	number of first active pixel on a line	byte	[0 to 255]
80	LPIX_ACT_LSB	number of last active pixel on a line	byte	[0 to 255]
81	FLINE_ACT_F0	number of first active line in field 0	byte	[0 to 255]
82	LLINE_ACT_F0	number of last active line in field 0	byte	[0 to 255]
83	FLINE_ACT_F1	number of first active line in field 1	byte	[0 to 255]
84	LLINE_ACT_F1	number of last active line in field 1	byte	[0 to 255]
85	ACT_LINES_MSB	MSBs of active line numbers; see Table 17	byte	[0 to 255]
86	PPG_POL_SEL	select polarity of the PPG output signals; see Table 18	5 bits	n.a.
128	ME_DPCC_A0_H_F1	ME data path control code A 0_H field 1	byte	[0 to 255]
129	ME_DPCC_A0_L_F1	ME data path control code A 0_L field 1	byte	[0 to 255]
130	ME_DPCC_B0_H_F1	ME data path control code B 0_H field 1	byte	[0 to 255]
131	ME_DPCC_B0_L_F1	ME data path control code B 0_L field 1	byte	[0 to 255]
132	ME_DPCC_A1_H_F1	ME data path control code A 1_H field 1	byte	[0 to 255]
133	ME_DPCC_A1_L_F1	ME data path control code A 1_L field 1	byte	[0 to 255]
134	ME_DPCC_B1_H_F1	ME data path control code B 1_H field 1	byte	[0 to 255]
135	ME_DPCC_B1_L_F1	ME data path control code B 1_L field 1	byte	[0 to 255]
136	ME_DPCC_A2_H_F1	ME data path control code A 2_H field 1	byte	[0 to 255]
137	ME_DPCC_A2_L_F1	ME data path control code A 2_L field 1	byte	[0 to 255]
138	ME_DPCC_B2_H_F1	ME data path control code B 2_H field 1	byte	[0 to 255]
139	ME_DPCC_B2_L_F1	ME data path control code B 2_L field 1	byte	[0 to 255]
140	ME_DPCC_A3_H_F1	ME data path control code A 3_H field 1	byte	[0 to 255]
141	ME_DPCC_A3_L_F1	ME data path control code A 3_L field 1	byte	[0 to 255]
142	ME_DPCC_B3_H_F1	ME data path control code B 3_H field 1	byte	[0 to 255]
143	ME_DPCC_B3_L_F1	ME data path control code B 3_L field 1	byte	[0 to 255]
144	ME_DPCC_A0_H_F2	ME data path control code A 0_H field 2	byte	[0 to 255]
145	ME_DPCC_A0_L_F2	ME data path control code A 0_L field 2	byte	[0 to 255]
146	ME_DPCC_B0_H_F2	ME data path control code B 0_H field 2	byte	[0 to 255]
147	ME_DPCC_B0_L_F2	ME data path control code B 0_L field 2	byte	[0 to 255]
148	ME_DPCC_A1_H_F2	ME data path control code A 1_H field 2	byte	[0 to 255]
149	ME_DPCC_A1_L_F2	ME data path control code A 1_L field 2	byte	[0 to 255]
150	ME_DPCC_B1_H_F2	ME data path control code B 1_H field 2	byte	[0 to 255]
151	ME_DPCC_B1_L_F2	ME data path control code B 1_L field 2	byte	[0 to 255]
152	ME_DPCC_A2_H_F2	ME data path control code A 2_H field 2	byte	[0 to 255]
153	ME_DPCC_A2_L_F2	ME data path control code A 2_L field 2	byte	[0 to 255]
154	ME_DPCC_B2_H_F2	ME data path control code B 2_H field 2	byte	[0 to 255]
155	ME_DPCC_B2_L_F2	ME data path control code B 2_L field 2	byte	[0 to 255]
156	ME_DPCC_A3_H_F2	ME data path control code A 3_H field 2	byte	[0 to 255]
157	ME_DPCC_A3_L_F2	ME data path control code A 3_L field 2	byte	[0 to 255]

Digital PC-camera signal processor

SAA8113HL

ADD	NAME	FUNCTION	FORMAT	RANGE
158	ME_DPCC_B3_H_F2	ME data path control code B 3_H field 2	byte	[0 to 255]
159	ME_DPCC_B3_L_F2	ME data path control code B 3_L field 2	byte	[0 to 255]
160	ME_RES_A0_H	ME data path result accuA 0_H	byte	[0 to 255]
161	ME_RES_A0_L	ME data path result accuA 0_L	byte	[0 to 255]
162	ME_RES_B0_H	ME data path result accuB 0_H	byte	[0 to 255]
163	ME_RES_B0_L	ME data path result accuB 0_L	byte	[0 to 255]
164	ME_RES_A1_H	ME data path result accuA 1_H	byte	[0 to 255]
165	ME_RES_A1_L	ME data path result accuA 1_L	byte	[0 to 255]
166	ME_RES_B1_H	ME data path result accuB 1_H	byte	[0 to 255]
167	ME_RES_B1_L	ME data path result accuB 1_L	byte	[0 to 255]
168	ME_RES_A2_H	ME data path result accuA 2_H	byte	[0 to 255]
169	ME_RES_A2_L	ME data path result accuA 2_L	byte	[0 to 255]
170	ME_RES_B2_H	ME data path result accuB 2_H	byte	[0 to 255]
171	ME_RES_B2_L	ME data path result accuB 2_L	byte	[0 to 255]
172	ME_RES_A3_H	ME data path result accuA 3_H	byte	[0 to 255]
173	ME_RES_A3_L	ME data path result accuA 3_L	byte	[0 to 255]
174	ME_RES_B3_H	ME data path result accuB 3_H	byte	[0 to 255]
175	ME_RES_B3_L	ME data path result accuB 3_L	byte	[0 to 255]
176	ME_SUBRES_A0_H	ME data path sub-result accuA 0_H	byte	[0 to 255]
177	ME_SUBRES_A0_L	ME data path sub-result accuA 0_L	byte	[0 to 255]
178	ME_SUBRES_B0_H	ME data path sub-result accuB 0_H	byte	[0 to 255]
179	ME_SUBRES_B0_L	ME data path sub-result accuB 0_L	byte	[0 to 255]
180	ME_SUBRES_A1_H	ME data path sub-result accuA 1_H	byte	[0 to 255]
181	ME_SUBRES_A1_L	ME data path sub-result accuA 1_L	byte	[0 to 255]
182	ME_SUBRES_B1_H	ME data path sub-result accuB 1_H	byte	[0 to 255]
183	ME_SUBRES_B1_L	ME data path sub-result accuB 1_L	byte	[0 to 255]
184	ME_SUBRES_A2_H	ME data path sub-result accuA 2_H	byte	[0 to 255]
185	ME_SUBRES_A2_L	ME data path sub-result accuA 2_L	byte	[0 to 255]
186	ME_SUBRES_B2_H	ME data path sub-result accuB 2_H	byte	[0 to 255]
187	ME_SUBRES_B2_L	ME data path sub-result accuB 2_L	byte	[0 to 255]
188	ME_SUBRES_A3_H	ME data path sub-result accuA 3_H	byte	[0 to 255]
189	ME_SUBRES_A3_L	ME data path sub-result accuA 3_L	byte	[0 to 255]
190	ME_SUBRES_B3_H	ME data path sub-result accuB 3_H	byte	[0 to 255]
191	ME_SUBRES_B3_L	ME data path sub-result accuB 3_L	byte	[0 to 255]
192	ME_WIN_START_0	simple window 0 (Vstart, Hstart)	4 bits	[0 to 15]
193	ME_WIN_STOP_0	simple window 0 (Vstop, Hstop)	4 bits	[0 to 15]
194	ME_WIN_START_1	simple window 1 (Vstart, Hstart)	4 bits	[0 to 15]
195	ME_WIN_STOP_1	simple window 1 (Vstop, Hstop)	4 bits	[0 to 15]
196	ME_WIN_START_2	simple window 2 (Vstart, Hstart)	4 bits	[0 to 15]
197	ME_WIN_STOP_2	simple window 2 (Vstop, Hstop)	4 bits	[0 to 15]
198	ME_WIN_START_3	simple window 3 (Vstart, Hstart)	4 bits	[0 to 15]

Digital PC-camera signal processor

SAA8113HL

ADD	NAME	FUNCTION	FORMAT	RANGE
199	ME_WIN_STOP_3	simple window 3 (Vstop, Hstop)	4 bits	[0 to 15]
200	ME_WIN_START_4	simple window 4 (Vstart, Hstart)	4 bits	[0 to 15]
201	ME_WIN_STOP_4	simple window 4 (Vstop, Hstop)	4 bits	[0 to 15]
202	ME_WIN_START_5	simple window 5 (Vstart, Hstart)	4 bits	[0 to 15]
203	ME_WIN_STOP_5	simple window 5 (Vstop, Hstop)	4 bits	[0 to 15]
204	ME_WIN_START_6	simple window 6 (Vstart, Hstart)	4 bits	[0 to 15]
205	ME_WIN_STOP_6	simple window 6 (Vstop, Hstop)	4 bits	[0 to 15]
206	ME_WIN_START_7	simple window 7 (Vstart, Hstart)	4 bits	[0 to 15]
207	ME_WIN_STOP_7	simple window 7 (Vstop, Hstop)	4 bits	[0 to 15]
208	ME_WIN_START_8	simple window 8 (Vstart, Hstart)	4 bits	[0 to 15]
209	ME_WIN_STOP_8	simple window 8 (Vstop, Hstop)	4 bits	[0 to 15]
210	ME_WIN_START_9	simple window 9 (Vstart, Hstart)	4 bits	[0 to 15]
211	ME_WIN_STOP_9	simple window 9 (Vstop, Hstop)	4 bits	[0 to 15]
212	ME_WIN_START_10	simple window 10 (Vstart, Hstart)	4 bits	[0 to 15]
213	ME_WIN_STOP_10	simple window 10 (Vstop, Hstop)	4 bits	[0 to 15]
214	ME_WIN_START_11	simple window 11 (Vstart, Hstart)	4 bits	[0 to 15]
215	ME_WIN_STOP_11	simple window 11 (Vstop, Hstop)	4 bits	[0 to 15]
216	ME_WIN_START_12	simple window 12 (Vstart, Hstart)	4 bits	[0 to 15]
218	ME_WIN_STOP_12	simple window 12 (Vstop, Hstop)	4 bits	[0 to 15]
219	ME_WIN_START_13	simple window 13 (Vstart, Hstart)	4 bits	[0 to 15]
220	ME_WIN_STOP_13	simple window 13 (Vstop, Hstop)	4 bits	[0 to 15]
221	ME_WIN_START_14	simple window 14 (Vstart, Hstart)	4 bits	[0 to 15]
222	ME_WIN_STOP_14	simple window 14 (Vstop, Hstop)	4 bits	[0 to 15]
223	ME_RAM_DUMMY_H	dummy read/write (additional RAM storage for 80C51)	byte	n.a.
224	ME_RAM_DUMMY_L	dummy read/write (additional RAM storage for 80C51)	byte	n.a.
225	HIGHLIGHTCOUNT_H	highlight counter H	byte	[0 to 255]
226	HIGHLIGHTCOUNT_L	highlight counter L	byte	[0 to 255]
227	AWBCOUNT_H	AWB counter H	byte	[0 to 255]
228	AWBCOUNT_L	AWB counter L	byte	[0 to 255]
229	ME_OB_PO_F0	measured optical black pixel odd field 0; see Table 19	byte	[0 to 127]
230	ME_OB_PE_F0	measured optical black pixel even field 0; see Table 20	byte	[0 to 127]
231	ME_OB_PO_F1	measured optical black pixel odd field 1; see Table 21	byte	[0 to 127]
232	ME_OB_PE_F1	measured optical black pixel even field 1; see Table 22	byte	[0 to 127]
254	DUMMY_READ	dummy read	byte	[0 to 255]
255	DUMMY_WRITE	dummy write	byte	[0 to 255]

Digital PC-camera signal processor

SAA8113HL

Table 5 Register details: address 0 CONTROL0

BIT	NAME	FUNCTION
CONTROL0.0		not used
CONTROL0.1	RGB_KNEE_K	compression factor for RGB_KNEE; see Table 6
CONTROL0.2	RGB_KNEE_K	compression factor for RGB_KNEE; see Table 6
CONTROL0.3	PIX_PHASE	toggle phase for pixel in colour separation
CONTROL0.4	LINE_PHASE	toggle phase for line in colour separation
CONTROL0.5	INTERLINE_PHASE	toggle colour filter structure (interline)
CONTROL0.6		not used
CONTROL0.7		not used

Table 6 Truth table for bits CONTROL0.1 and CONTROL0.2

BIT NUMBER		COMPRESSION FACTOR
2	1	
0	0	1/8
0	1	1/4
1	0	3/8
1	1	1/2

Table 7 Register details: address 1 CONTROL1

BIT	NAME	FUNCTION
CONTROL1.0	FR_WIDE	FR wide/narrow
CONTROL1.1	FR_SHIFT	FR shifted/unshifted
CONTROL1.2	FS_WIDE	FS wide/narrow
CONTROL1.3	DUALPOWER	SHARP dual power/other sensor select
CONTROL1.4	SHARP	SHARP/PANASONIC sensor select
CONTROL1.5	PAL_NTSC	choose between PAL/NTSC
CONTROL1.6	BCP_MODE	select BCP mode 1/0
CONTROL1.7	CP_TOGGLE	carrier phase toggle/not toggle

Table 8 Register details: address 2 CONTROL2

BIT	NAME	FUNCTION
CONTROL2.0	CATCH_CCD	catch CCD data/normal operation
CONTROL2.1	HFE_BYPASS	high frequency enhancer bypass/active
CONTROL2.2	Y_TEST	select y_test from RGB2(Y)UV instead of Y on/off
CONTROL2.3	MOD_BYPASS	chrominance modulator bypass/active
CONTROL2.4	DOUBLE_C	scale chrominance with factor 2 on/off
CONTROL2.5	Y_SEL	select as luminance input (F0) Y _a /y _n
CONTROL2.6	VCONTOUR_LPF	switch vertical contour LPF on/off
CONTROL2.7	FADER_IMPL	select fader implementation n1/n2

Digital PC-camera signal processor

SAA8113HL

Table 9 Register details: address 36 CONGAIN

NAME	FUNCTION
CONGAIN.0 to CONGAIN.5	contour gain factor (0 to 63/16)
CONGAIN.6	contour gain fading off/on

Table 10 Register details: address 60 ME_RESSCALE

NAME	FUNCTION
ME_RESSCALE.0 to ME_RESSCALE.2	ME result scaler selection (0, 2, 4, 8 and 16)
MECNTRL.3	ME synchronization (synchronize field/frame toggle of Measurement Engine)

Table 11 Register details: address 61 DISP_CNTRL

NAME	FUNCTION
DISP_CNTRL.0 and DISP_CNTRL.1	V display level
DISP_CNTRL.2 and DISP_CNTRL.3	U display level
DISP_CNTRL.4	contrast reduction/level insertion
DISP_CNTRL.5 to DISP_CNTRL.7	display signal selection code; see Table 12

Table 12 Truth table for bits DISP_CNTRL5 to DISP_CNTRL7]

BIT NUMBER			SELECT CODE
7	6	5	
0	0	0	no display
0	0	1	D_VU
0	1	0	D_WC
0	1	1	D_AWBVAL
1	0	0	D_HIGHLIGHT
1	0	1	D_MWG
1	1	X	D_CONTOUR

Table 13 Register details: address 63 DMWSEL

NAME	FUNCTION
DMWSEL.0	display measurement window A for line 0
DMWSEL.1	display measurement window B for line 0
DMWSEL.2	display measurement window A for line 1
DMWSEL.3	display measurement window B for line 1
DMWSEL.4	display measurement window A for line 2
DMWSEL.5	display measurement window B for line 2
DMWSEL.6	display measurement window A for line 3
DMWSEL.7	display measurement window B for line 3

Digital PC-camera signal processor

SAA8113HL

Table 14 Register details: address 66 PRE_SI_MSB

NAME	FUNCTION
PRE_SI_MSB.0 and PRE_SI_MSB.1	control data bits d8 and d9
PRE_SI_MSB.2 to PRE_SI_MSB.4	control address bits a0 to a2

Table 15 Register details: address 68 CDAC_DATA

NAME	FUNCTION
CDAC_DATA.0 to CDAC_DATA.6	CDAC data bits 0 to 6

Table 16 Register details: address 78 MISC_CONTROL

NAME	FUNCTION
MISC_CONTROL.0	LED off/on
MISC_CONTROL.1	audio on/off
MISC_CONTROL.2	audio gain low (13 dB), high (45 dB)
MISC_CONTROL.3	select 1 k Ω mode (output impedance)
MISC_CONTROL.4	standby on/off
MISC_CONTROL.5 to MISC_CONTROL.7	reserved for miscellaneous additional functions

Table 17 Register details: address 85 ACT_LINES_MSB

NAME	FUNCTION
ACT_LINES_MSB.0 and ACT_LINES_MSB.1	bits 8 and 9 for last active pixel number on a line
ACT_LINES_MSB.2 and ACT_LINES_MSB.3	bits 8 and 9 for last active line number in field 0
ACT_LINES_MSB.4 and ACT_LINES_MSB.5	bits 8 and 9 for first active line number in field 1/frame
ACT_LINES_MSB.6 and ACT_LINES_MSB.7	bits 8 and 9 for last active line number in field 1/frame

Table 18 Register details: address 86 PPG_POL_SEL

Name	FUNCTION
PPG_POL_SEL.0	select polarity of PPG output FR as inverted/non-inverted
PPG_POL_SEL.1	select polarity of PPG output FS as inverted/non-inverted
PPG_POL_SEL.2	select polarity of PPG output FCDS as inverted/non-inverted
PPG_POL_SEL.3	select polarity of PPG output FH1 as inverted/non-inverted
PPG_POL_SEL.4	select polarity of PPG output FH2 as inverted/non-inverted

Table 19 Register details: address 229 ME_OB_PO_F0

NAME BIT NO	FUNCTION	
	CCD_CATCH = 0	CCD_CATCH = 1
ME_OB_PO_F0.0 to ME_OB_PO_F0.6	ME_OB_PO_F00 to ME_OB_PO_F06	CCD2 to CCD8
ME_OB_PO_F0.7	0	CCD9

Digital PC-camera signal processor

SAA8113HL

Table 20 Register details: address 230 ME_OB_PE_F0

NAME BIT NO	FUNCTION	
	CCD_CATCH = 0	CCD_CATCH = 1
ME_OB_PE_F0.0 and ME_OB_PE_F0.1	ME_OB_PE_F00 and ME_OB_PE_F01	CCD0 and CCD1
ME_OB_PE_F0.2 to ME_OB_PE_F0.6	ME_OB_PE_F02 to ME_OB_PE_F06	0
ME_OB_PE_F0.7	KNOB4	

Table 21 Register details: address 231 ME_OB_PO_F1

NAME BIT NO	FUNCTION	
	CCD_CATCH = 0	CCD_CATCH = 1
ME_OB_PO_F1.0 to ME_OB_PO_F1.6	ME_OB_PO_F16 to ME_OB_PO_F10	'undefined'
ME_OB_PO_F1.7	0	

Table 22 Register details: address 232 ME_OB_PE_F1

NAME BIT NO	FUNCTION	
	CCD_CATCH = 01	CCD_CATCH = 1
ME_OB_PE_F1.0 to ME_OB_PE_F1.6	ME_OB_PE_F16 to ME_OB_PE_F10	'undefined'
ME_OB_PE_F1.7	0	

9 LIMITING VALUES

In accordance with the Absolute Maximum Rating System (IEC 134); note 1 unless otherwise specified.

SYMBOL	PARAMETER	CONDITIONS	MIN.	MAX.	UNIT
V _{DDn}	digital supply voltages 1 and 2 for input buffer and pre-drivers		-0.5	+4.0	V
V _{DDAn}	analog supply voltages 1, 5, 8 and 9 for output buffers		-0.5	+4.0	V
V _{DDA2}	analog supply voltage 2 for DAC output buffer		-0.5	+4.0	V
V _{DDA3}	analog supply voltage 3 for analog DAC core and band gap		-0.5	+4.0	V
V _{DDA4}	analog supply voltage 4 for audio buffer		-0.5	+4.0	V
V _{DDA6}	analog supply voltage 6 for CDAC		-0.5	+4.0	V
V _{DDA7}	analog supply voltage 7 for 38 MHz crystal oscillator		-0.5	+4.0	V
DGND _n	digital grounds 1, 2, and 3 for input buffer and predrivers		-0.5	+4.0	V
AGND _n	analog grounds 1, 7, 10 and 11 for output buffers		-0.5	+4.0	V
AGND2	analog ground 2 for DAC output buffer		-0.5	+4.0	V
AGND3	analog ground 3 for analog DAC core and band gap, connected to substrate		-0.5	+4.0	V
AGND4	analog ground 4 for analog DAC core and band gap, not connected to substrate		-0.5	+4.0	V
AGND6	analog ground 6 for audio buffer connected to substrate		-0.5	+4.0	V
AGND5	analog ground 5 for audio buffer not connected to substrate		-0.5	+4.0	V
AGND8	analog ground 8 for CDAC		-0.5	+4.0	V
AGND9	analog ground 9 for 38 MHz crystal oscillator		-0.5	+4.0	V

Digital PC-camera signal processor

SAA8113HL

SYMBOL	PARAMETER	CONDITIONS	MIN.	MAX.	UNIT
V _I , V _O	input or output voltage		-0.5	V _{DD} + 0.5	V
		note 2	-0.5	+5.5	V
T _{stg}	storage temperature		-55	+150	°C
T _{amb}	ambient temperature		0	70	°C
T _j	junction temperature		-40	+125	°C

Notes

1. Stress beyond these levels may cause permanent damage to the device.
2. For 5 V-tolerant buffers.

10 THERMAL CHARACTERISTICS

SYMBOL	PARAMETER	CONDITIONS	VALUE	UNIT
R _{th(j-a)}	thermal resistance from junction to ambient	in free air	56	K/W

11 OPERATING CHARACTERISTICS

V_{DDD} = V_{DDA} = 3.3 V ±10%; T_{amb} = 0 to 70 °C; unless otherwise specified.

SYMBOL	PARAMETER	CONDITIONS	MIN.	TYP.	MAX.	UNIT
General supplies						
V _{DDD}	digital supply voltage		3.0	3.3	3.6	V
V _{DDA}	analog supply voltage		3.0	3.3	3.6	V
DGND	digital ground		-0.3	0.0	+0.3	V
AGND	analog ground		-0.3	0.0	+0.3	V
I _{DDD}	digital supply current	T _{amb} = 25 °C	-	45	-	mA
I _{DDA}	analog supply current	T _{amb} = 25 °C	-	15	-	mA
T _{amb}	ambient temperature		0	25	70	°C
Data and control inputs or I/Os (CCD9 to CCD0, M2 to M0, KNOB4 to KNOB0, RESET, EA, T1, INT1 and P0.7 to P0.0)						
V _{IL}	LOW-level input voltage		-	-	0.2V _{DDD}	V
V _{IH}	HIGH-level input voltage		0.8V _{DDD}	-	-	V
Data and control outputs or I/Os (SMP, LED, OUTBVEN, OUTGAIN, SDATA, SCLK, SDAE, SCLE, STROBE, STNDBY, FR, OFDX, AD14 to AD8 and P0.7 to P0.0)						
V _{OL}	LOW-level output voltage		0	-	0.4	V
V _{OH}	HIGH-level output voltage		0.85V _{DDD}	-	V _{DDD}	V
Control outputs (FH1, FH2, FS, FCDS and CLK1)						
V _{OL}	LOW-level output voltage	note 1	-	-	0.8	V
V _{OH}	HIGH-level output voltage	note1	2.2	-	-	V
Control outputs (V1X, V2X, V3X, V4X, VH1X and VH3X)						
V _{OL}	LOW-level output voltage	notes 2 and 3	-	-	0.8	V
V _{OH}	HIGH-level output voltage	notes 2 and 3	2.6	-	-	V

Digital PC-camera signal processor

SAA8113HL

SYMBOL	PARAMETER	CONDITIONS	MIN.	TYP.	MAX.	UNIT
Control outputs (BCP and DCP)						
V_{OL}	LOW-level output voltage		–	–	0.6	V
V_{OH}	HIGH-level output voltage		2.2	–	–	V
Switch Mode Pulse for DC-to-DC power supply (SMP)						
I_o	output current		3	–	–	mA
Output to drive the LED (LED)						
I_o	output current		5	–	–	mA

Notes

1. Connected to HCT (lab resources) with $V_{IH(min)} = 2.0$ V and $V_{IL(max)} = 0.8$ V.
2. Connected to NEC μ PD16510 with $V_{IH(min)} = 0.8V_{DD}$ and $V_{IL(max)} = 0.3V_{DD}$.
3. Connected to ACT/HCT (lab resources) with $V_{IH(min)} = 2.0$ V and $V_{IL(max)} = 0.8$ V.

12 ELECTRICAL CHARACTERISTICS

$V_{DD} = V_{DDA} = 3.3$ V $\pm 10\%$; $T_{amb} = 0$ to 70 °C; unless otherwise specified.

SYMBOL	PARAMETERS	CONDITIONS	MIN.	TYP.	MAX.	UNIT
CDAC specifications						
LOAD						
R_L	load resistance		10	–	–	k Ω
C_L	load capacitance		–	–	100	pF
TRANSFER FUNCTION						
V_O	DC output voltage	at code '0'	–	0.00	0.05	V
	DC output voltage	at code '127'	$V_{DD} - 0.2$	$V_{DD} - 0.12$	V_{DD}	V
RES	resolution		–	7	–	bit
DNL	differential non-linearity		–	–	1/2	LSB
INL	integral non-linearity		–	–	1	LSB
CR	conversion rate		–	–	60	Hz
B_A	analog bandwidth		–	–	60	Hz
R_o	output resistance		–	13	–	Ω
SWITCHING CHARACTERISTICS ON RISING FULL-SCALE STEP						
t_{PD}	propagation delay time	to 50% value	–	–	75	ns
t_{st1}	settling time	10% to 90% full-scale	–	–	120	ns
t_{st2}	settling time	to ± 1 LSB	–	–	156	ns

Digital PC-camera signal processor

SAA8113HL

SYMBOL	PARAMETERS	CONDITIONS	MIN.	TYP.	MAX.	UNIT
VDAC specifications						
LOAD						
R _L	load resistance	with high impedance (1 kΩ mode)	0.8	1	–	kΩ
C _L	load capacitance	with high impedance (1 kΩ mode)	–	–	5	pF
TRANSFER FUNCTION						
V _{o(0)}	DC output voltage at code '0'		0.15	0.212	0.30	V
V _{o(436)}	DC output voltage at code '436'		1.45	1.55	1.75	V
V _{RL(p-p)}	output voltage (436 to 0) (peak-to-peak value)	note 1	1.15	1.288	1.6	V
RES	resolution		–	9	–	bit
DNL	differential non-linearity		–	–	1/2	LSB
INL	integral non-linearity		–	–	1	LSB
CR	conversion rate		–	19	–	MHz
f _{CLK}	clock frequency		–	19	–	MHz
B _A	analog bandwidth		–	6.5	–	MHz
S/N	signal-to-noise ratio	dynamic	43	46	–	dB
THD	total harmonic distortion		–	–50	–42	dB
R _o	output resistance		–	2	3	Ω
SWITCHING CHARACTERISTICS ON RISING FULL-SCALE STEP						
t _{PD}	propagation delay time	to 50% value	–	–	13	ns
t _{st1}	settling time	10% to 90% full-scale	–	–	15	ns
t _{st2}	settling time	to ±1 LSB	–	–	50	ns
Audio amplifier specifications						
LOAD						
R _L	load resistance		5	–	–	kΩ
C _L	load capacitance		–	5	–	pF
TRANSFER FUNCTION						
V _{i(p-p)}	nominal input level (peak-to-peak value)		–	5.6	–	mV
A1	amplification at high level		43	44.8	47	dB
			141.2	173.7	223.8	
A2	amplification at low level		11	12.5	14	dB
			3.5	4.2	5.0	
V _{OH(p-p)}	nominal output level at high level (peak-to-peak value)		–	0.97	–	V

Digital PC-camera signal processor

SAA8113HL

SYMBOL	PARAMETERS	CONDITIONS	MIN.	TYP.	MAX.	UNIT
$V_{OL(rms)}$	nominal output level at high level (RMS value)		–	0.34	–	V
$V_{o2(p-p)}$	nominal output level at low level (peak-to-peak value)		–	23.5	–	mV
$V_{o2(rms)}$	nominal output level at low level (RMS value)		–	8.3	–	mV
$V_{o(max)(p-p)}$	maximum output level (peak-to-peak value)		2	–	–	V
S/N	signal-to-noise ratio		40	–	–	dB
THD	total harmonic distortion at high level		–	–60	–50	dB
Z_i	input impedance		5	–	–	k Ω
Z_o	output impedance		–	–	100	Ω
B-3 dB	frequency range (–3 dB)		0.1	–	20	kHz
BIASSING						
I_{ref}	reference current		–	25	–	μ A
Data input/output timing; (see Fig.13)						
DATA INPUTS RELATED TO XIN (CCD9 TO CCD0 AND KNOB4)						
$t_{su(i)(D)}$	data input setup time	note 2	9.5	–	–	ns
$t_{h(i)(D)}$	data input hold time	note 2	10.5	–	–	ns
DATA OUTPUTS RELATED TO XIN (OUTBVEN, OUTGAIN, SMP, LED, SDATA, SCLK, STROBE AND STNDBY)						
$t_{h(o)(D)}$	data output delay time	note 2	–	5	7	ns
$t_{d(o)(D)}$	data output hold time	note 2	–	3	5.5	ns
PPG high speed pulse timing; $C_L = 10$ pF (see Fig.14)						
t_{d1}	FH2 fall time delay w.r.t. the rising edge of FH1		–3	0	+3	ns
t_{d2}	FH2 rise time delay w.r.t. the falling edge of FH1		–3	0	+3	ns
t_{d3}	FR fall time delay w.r.t. the rising edge of FH1		0	1	2	ns
$t_{d3_delayed}$	FR_delayed fall time delay w.r.t. the rising edge of FH1		7	8	10	ns
t_{d4_wide}	FCDS fall time delay w.r.t. the rising edge of FR_wide		1	2	3	ns
t_{d4_narrow}	FCDS fall time delay w.r.t. the rising edge of FR_narrow		14	15	16	ns
t_{d5}	FH1 fall time delay w.r.t. the rising edge of FCDS		0	1	2	ns
t_{d6_wide}	FH1 rise time delay w.r.t. the rising edge of FS_wide		0	1	2	ns
t_{d6_narrow}	FH1 rise time delay w.r.t. the rising edge of FS_narrow		14	15	16	ns
t_{d7}	CLK1 fall time delay w.r.t. the rising edge of FH1		0	1	2	ns

Digital PC-camera signal processor

SAA8113HL

SYMBOL	PARAMETERS	CONDITIONS	MIN.	TYP.	MAX.	UNIT
t_{d8}	CLK1 rise time delay w.r.t. the falling edge of FH1		0	1	2	ns
t_{wFH1}	FH1 pulse width		–	53	–	ns
t_{rFH1}	FH1 rise time		–	4	–	ns
t_{fFH1}	FH1 fall time		–	4	–	ns
t_{wFH2}	FH2 pulse width		–	53	–	ns
t_{rFH2}	FH2 rise time		–	4	–	ns
t_{fFH2}	FH2 fall time		–	4	–	ns
t_{wFR_wide}	FR_wide pulse width		–	26	–	ns
t_{wFR_narrow}	FR_narrow pulse width		–	13	–	ns
t_{rFR}	FR rise time		–	4	–	ns
t_{fFR}	FR fall time		–	4	–	ns
t_{wFCDS}	FCDS pulse width		–	26	–	ns
t_{rFCDS}	FCDS rise time		–	4	–	ns
t_{fFCDS}	FCDS fall time		–	4	–	ns
t_{wFS_wide}	FS_wide pulse width		–	40	–	ns
t_{wFS_narrow}	FS_narrow pulse width		–	26	–	ns
t_{rFS}	FS rise time		–	4	–	ns
t_{fFS}	FS fall time		–	4	–	ns
t_{wCLK1}	CLK1 pulse width		–	53	–	ns

Notes

1. Full code swing of colour bar with maximum headroom of 16.4%. Above code '436', the DAC works but the settling time will decrease gradually.
2. The internal clock signal used in the DSP core is derived from XIN: XIN divided by 4.

Digital PC-camera signal processor

SAA8113HL

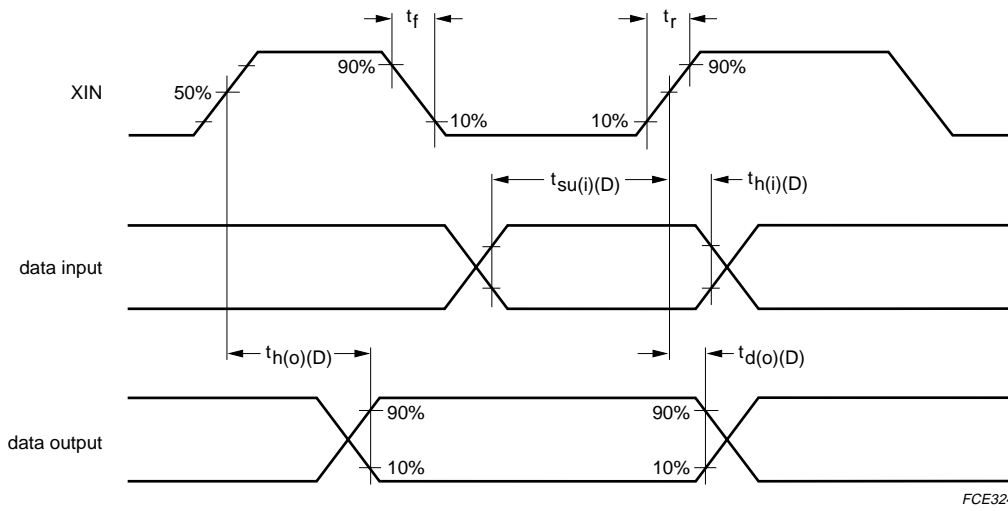

Fig.13 Data input/output timing.

Digital PC-camera signal processor

SAA8113HL

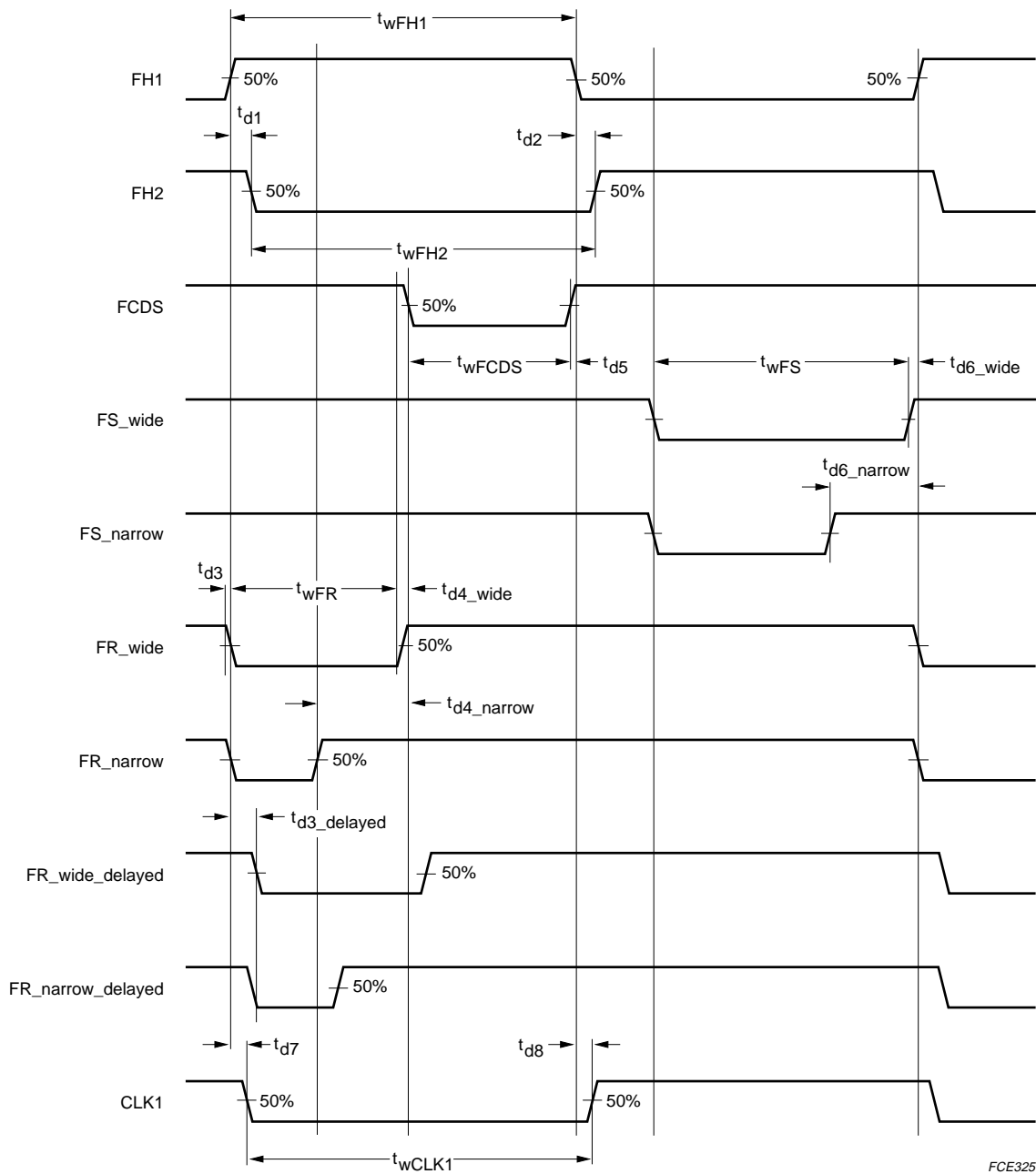

Fig.14 PPG high speed pulse timing diagram.

Digital PC-camera signal processor

SAA8113HL

13 APPLICATION INFORMATION

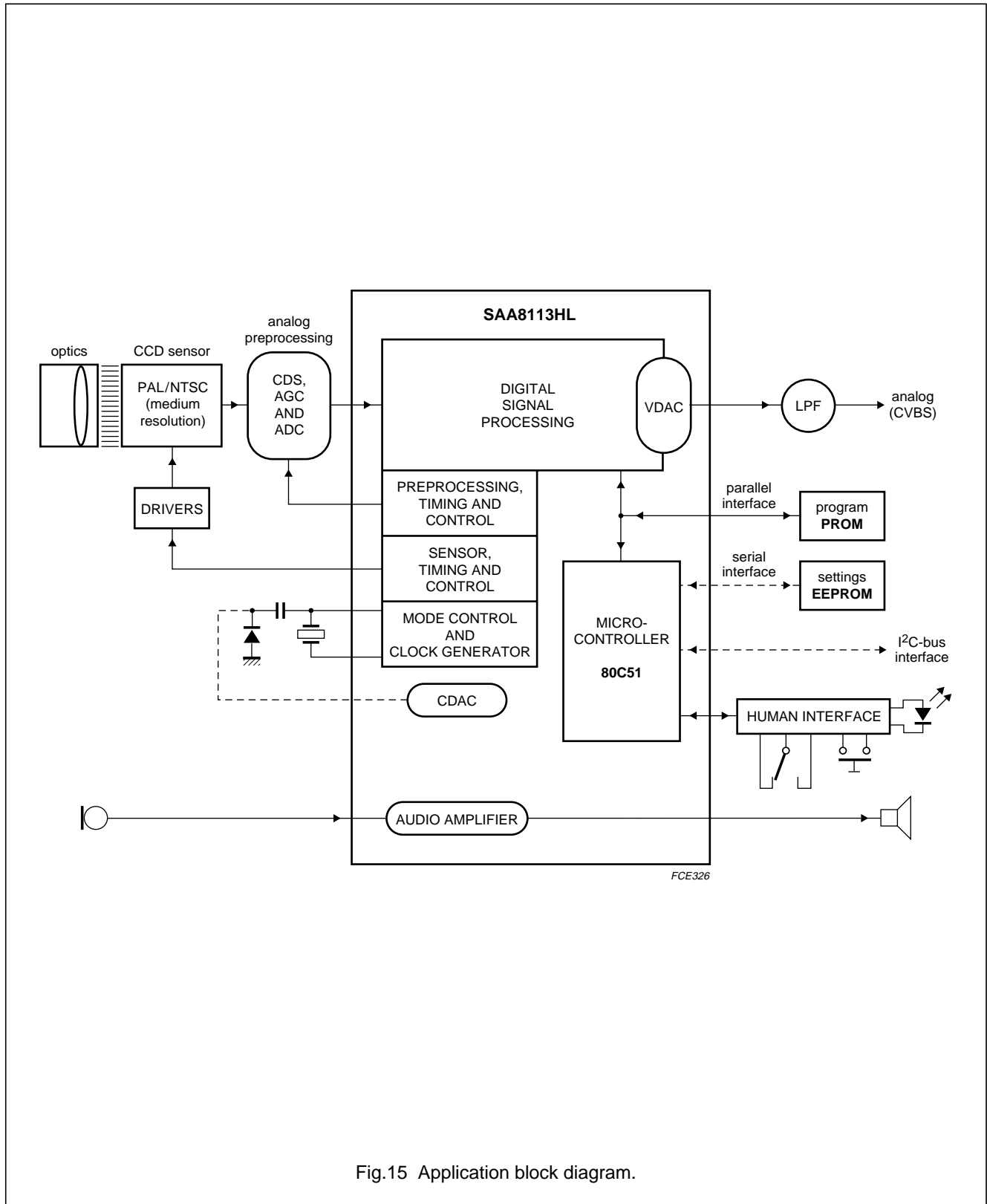

Fig.15 Application block diagram.

Digital PC-camera signal processor

SAA8113HL

14 PACKAGE OUTLINE

LQFP100: plastic low profile quad flat package; 100 leads; body 14 x 14 x 1.4 mm

SOT407-1

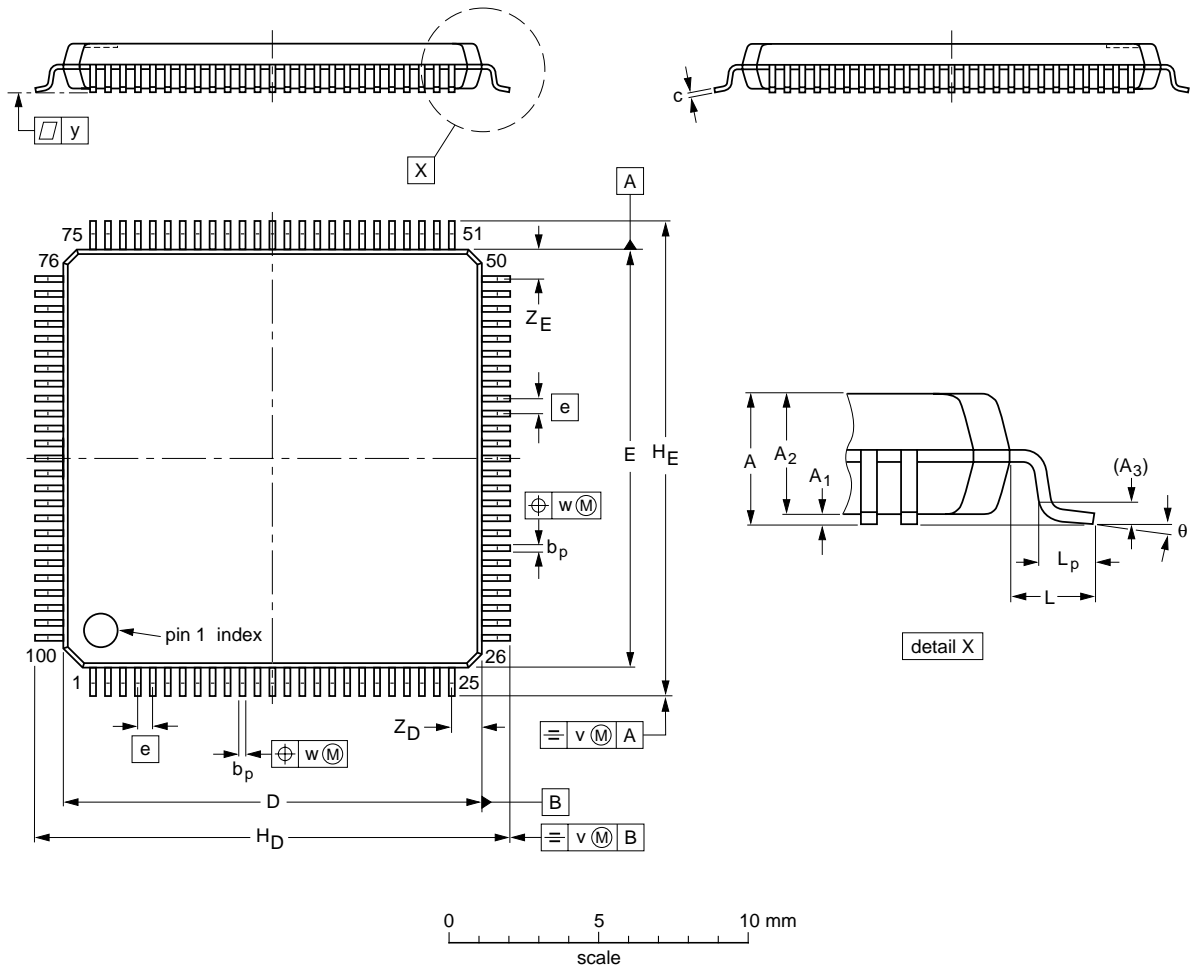

DIMENSIONS (mm are the original dimensions)

UNIT	A max.	A ₁	A ₂	A ₃	b _p	c	D ⁽¹⁾	E ⁽¹⁾	e	H _D	H _E	L	L _p	v	w	y	Z _D ⁽¹⁾	Z _E ⁽¹⁾	θ
mm	1.6	0.20 0.05	1.5 1.3	0.25	0.28 0.16	0.18 0.12	14.1 13.9	14.1 13.9	0.5	16.25 15.75	16.25 15.75	1.0	0.75 0.45	0.2	0.12	0.1	1.15 0.85	1.15 0.85	7° 0°

Note

1. Plastic or metal protrusions of 0.25 mm maximum per side are not included.

OUTLINE VERSION	REFERENCES				EUROPEAN PROJECTION	ISSUE DATE
	IEC	JEDEC	EIAJ			
SOT407-1						95-12-19 97-08-04

Digital PC-camera signal processor

SAA8113HL

15 SOLDERING

15.1 Introduction to soldering surface mount packages

This text gives a very brief insight to a complex technology. A more in-depth account of soldering ICs can be found in our *"Data Handbook IC26; Integrated Circuit Packages"* (document order number 9398 652 90011).

There is no soldering method that is ideal for all surface mount IC packages. Wave soldering is not always suitable for surface mount ICs, or for printed-circuit boards with high population densities. In these situations reflow soldering is often used.

15.2 Reflow soldering

Reflow soldering requires solder paste (a suspension of fine solder particles, flux and binding agent) to be applied to the printed-circuit board by screen printing, stencilling or pressure-syringe dispensing before package placement.

Several methods exist for reflowing; for example, infrared/convection heating in a conveyor type oven. Throughput times (preheating, soldering and cooling) vary between 100 and 200 seconds depending on heating method.

Typical reflow peak temperatures range from 215 to 250 °C. The top-surface temperature of the packages should preferably be kept below 230 °C.

15.3 Wave soldering

Conventional single wave soldering is not recommended for surface mount devices (SMDs) or printed-circuit boards with a high component density, as solder bridging and non-wetting can present major problems.

To overcome these problems the double-wave soldering method was specifically developed.

If wave soldering is used the following conditions must be observed for optimal results:

- Use a double-wave soldering method comprising a turbulent wave with high upward pressure followed by a smooth laminar wave.
- For packages with leads on two sides and a pitch (e):
 - larger than or equal to 1.27 mm, the footprint longitudinal axis is **preferred** to be parallel to the transport direction of the printed-circuit board;
 - smaller than 1.27 mm, the footprint longitudinal axis **must** be parallel to the transport direction of the printed-circuit board.

The footprint must incorporate solder thieves at the downstream end.

- For packages with leads on four sides, the footprint must be placed at a 45° angle to the transport direction of the printed-circuit board. The footprint must incorporate solder thieves downstream and at the side corners.

During placement and before soldering, the package must be fixed with a droplet of adhesive. The adhesive can be applied by screen printing, pin transfer or syringe dispensing. The package can be soldered after the adhesive is cured.

Typical dwell time is 4 seconds at 250 °C. A mildly-activated flux will eliminate the need for removal of corrosive residues in most applications.

15.4 Manual soldering

Fix the component by first soldering two diagonally-opposite end leads. Use a low voltage (24 V or less) soldering iron applied to the flat part of the lead. Contact time must be limited to 10 seconds at up to 300 °C.

When using a dedicated tool, all other leads can be soldered in one operation within 2 to 5 seconds between 270 and 320 °C.

Digital PC-camera signal processor

SAA8113HL

15.5 Suitability of surface mount IC packages for wave and reflow soldering methods

PACKAGE	SOLDERING METHOD	
	WAVE	REFLOW ⁽¹⁾
BGA, SQFP	not suitable	suitable
HLQFP, HSQFP, HSOP, HTSSOP, SMS	not suitable ⁽²⁾	suitable
PLCC ⁽³⁾ , SO, SOJ	suitable	suitable
LQFP, QFP, TQFP	not recommended ⁽³⁾⁽⁴⁾	suitable
SSOP, TSSOP, VSO	not recommended ⁽⁵⁾	suitable

Notes

1. All surface mount (SMD) packages are moisture sensitive. Depending upon the moisture content, the maximum temperature (with respect to time) and body size of the package, there is a risk that internal or external package cracks may occur due to vaporization of the moisture in them (the so called popcorn effect). For details, refer to the Drypack information in the *"Data Handbook IC26; Integrated Circuit Packages; Section: Packing Methods"*.
2. These packages are not suitable for wave soldering as a solder joint between the printed-circuit board and heatsink (at bottom version) can not be achieved, and as solder may stick to the heatsink (on top version).
3. If wave soldering is considered, then the package must be placed at a 45° angle to the solder wave direction. The package footprint must incorporate solder thieves downstream and at the side corners.
4. Wave soldering is only suitable for LQFP, TQFP and QFP packages with a pitch (e) equal to or larger than 0.8 mm; it is definitely not suitable for packages with a pitch (e) equal to or smaller than 0.65 mm.
5. Wave soldering is only suitable for SSOP and TSSOP packages with a pitch (e) equal to or larger than 0.65 mm; it is definitely not suitable for packages with a pitch (e) equal to or smaller than 0.5 mm.

Digital PC-camera signal processor

SAA8113HL

16 DEFINITIONS

Data sheet status	
Objective specification	This data sheet contains target or goal specifications for product development.
Preliminary specification	This data sheet contains preliminary data; supplementary data may be published later.
Product specification	This data sheet contains final product specifications.
Limiting values	
Limiting values given are in accordance with the Absolute Maximum Rating System (IEC 134). Stress above one or more of the limiting values may cause permanent damage to the device. These are stress ratings only and operation of the device at these or at any other conditions above those given in the Characteristics sections of the specification is not implied. Exposure to limiting values for extended periods may affect device reliability.	
Application information	
Where application information is given, it is advisory and does not form part of the specification.	

17 LIFE SUPPORT APPLICATIONS

These products are not designed for use in life support appliances, devices, or systems where malfunction of these products can reasonably be expected to result in personal injury. Philips customers using or selling these products for use in such applications do so at their own risk and agree to fully indemnify Philips for any damages resulting from such improper use or sale.

18 PURCHASE OF PHILIPS I²C COMPONENTS



Purchase of Philips I²C components conveys a license under the Philips' I²C patent to use the components in the I²C system provided the system conforms to the I²C specification defined by Philips. This specification can be ordered using the code 9398 393 40011.

Digital PC-camera signal processor

SAA8113HL

NOTES

Philips Semiconductors – a worldwide company

Argentina: see South America

Australia: 3 Figtree Drive, HOMEBUSH, NSW 2140,
Tel. +61 2 9704 8141, Fax. +61 2 9704 8139

Austria: Computerstr. 6, A-1101 WIEN, P.O. Box 213,
Tel. +43 1 60 101 1248, Fax. +43 1 60 101 1210

Belarus: Hotel Minsk Business Center, Bld. 3, r. 1211, Volodarski Str. 6,
220050 MINSK, Tel. +375 172 20 0733, Fax. +375 172 20 0773

Belgium: see The Netherlands

Brazil: see South America

Bulgaria: Philips Bulgaria Ltd., Energoproject, 15th floor,
51 James Bourchier Blvd., 1407 SOFIA,
Tel. +359 2 68 9211, Fax. +359 2 68 9102

Canada: PHILIPS SEMICONDUCTORS/COMPONENTS,
Tel. +1 800 234 7381, Fax. +1 800 943 0087

China/Hong Kong: 501 Hong Kong Industrial Technology Centre,
72 Tat Chee Avenue, Kowloon Tong, HONG KONG,
Tel. +852 2319 7888, Fax. +852 2319 7700

Colombia: see South America

Czech Republic: see Austria

Denmark: Sydhavnsgade 23, 1780 COPENHAGEN V,
Tel. +45 33 29 3333, Fax. +45 33 29 3905

Finland: Sinikalliontie 3, FIN-02630 ESPOO,
Tel. +358 9 615 800, Fax. +358 9 6158 0920

France: 51 Rue Carnot, BP317, 92156 SURESNES Cedex,
Tel. +33 1 4099 6161, Fax. +33 1 4099 6427

Germany: Hammerbrookstraße 69, D-20097 HAMBURG,
Tel. +49 40 2353 60, Fax. +49 40 2353 6300

Hungary: see Austria

India: Philips INDIA Ltd, Band Box Building, 2nd floor,
254-D, Dr. Annie Besant Road, Worli, MUMBAI 400 025,
Tel. +91 22 493 8541, Fax. +91 22 493 0966

Indonesia: PT Philips Development Corporation, Semiconductors Division,
Gedung Philips, Jl. Buncit Raya Kav.99-100, JAKARTA 12510,
Tel. +62 21 794 0040 ext. 2501, Fax. +62 21 794 0080

Ireland: Newstead, Clonskeagh, DUBLIN 14,
Tel. +353 1 7640 000, Fax. +353 1 7640 200

Israel: RAPAC Electronics, 7 Kehilat Saloniki St, PO Box 18053,
TEL AVIV 61180, Tel. +972 3 645 0444, Fax. +972 3 649 1007

Italy: PHILIPS SEMICONDUCTORS, Via Casati, 23 - 20052 MONZA (MI),
Tel. +39 039 203 6838, Fax +39 039 203 6800

Japan: Philips Bldg 13-37, Kohnan 2-chome, Minato-ku,
TOKYO 108-8507, Tel. +81 3 3740 5130, Fax. +81 3 3740 5057

Korea: Philips House, 260-199 Itaewon-dong, Yongsan-ku, SEOUL,
Tel. +82 2 709 1412, Fax. +82 2 709 1415

Malaysia: No. 76 Jalan Universiti, 46200 PETALING JAYA, SELANGOR,
Tel. +60 3 750 5214, Fax. +60 3 757 4880

Mexico: 5900 Gateway East, Suite 200, EL PASO, TEXAS 79905,
Tel. +9-5 800 234 7381, Fax +9-5 800 943 0087

Middle East: see Italy

Netherlands: Postbus 90050, 5600 PB EINDHOVEN, Bldg. VB,
Tel. +31 40 27 82785, Fax. +31 40 27 88399

New Zealand: 2 Wagener Place, C.P.O. Box 1041, AUCKLAND,
Tel. +64 9 849 4160, Fax. +64 9 849 7811

Norway: Box 1, Manglerud 0612, OSLO,
Tel. +47 22 74 8000, Fax. +47 22 74 8341

Pakistan: see Singapore

Philippines: Philips Semiconductors Philippines Inc.,
106 Valero St. Salcedo Village, P.O. Box 2108 MCC, MAKATI,
Metro MANILA, Tel. +63 2 816 6380, Fax. +63 2 817 3474

Poland: Al.Jerozolimskie 195 B, 02-222 WARSAW,
Tel. +48 22 5710 000, Fax. +48 22 5710 001

Portugal: see Spain

Romania: see Italy

Russia: Philips Russia, Ul. Usatcheva 35A, 119048 MOSCOW,
Tel. +7 095 755 6918, Fax. +7 095 755 6919

Singapore: Lorong 1, Toa Payoh, SINGAPORE 319762,
Tel. +65 350 2538, Fax. +65 251 6500

Slovakia: see Austria

Slovenia: see Italy

South Africa: S.A. PHILIPS Pty Ltd., 195-215 Main Road Martindale,
2092 JOHANNESBURG, P.O. Box 58088 Newville 2114,
Tel. +27 11 471 5401, Fax. +27 11 471 5398

South America: Al. Vicente Pinzon, 173, 6th floor,
04547-130 SÃO PAULO, SP, Brazil,
Tel. +55 11 821 2333, Fax. +55 11 821 2382

Spain: Balmes 22, 08007 BARCELONA,
Tel. +34 93 301 6312, Fax. +34 93 301 4107

Sweden: Kottbygatan 7, Akalla, S-16485 STOCKHOLM,
Tel. +46 8 5985 2000, Fax. +46 8 5985 2745

Switzerland: Allmendstrasse 140, CH-8027 ZÜRICH,
Tel. +41 1 488 2741 Fax. +41 1 488 3263

Taiwan: Philips Semiconductors, 6F, No. 96, Chien Kuo N. Rd., Sec. 1,
TAIPEI, Taiwan Tel. +886 2 2134 2886, Fax. +886 2 2134 2874

Thailand: PHILIPS ELECTRONICS (THAILAND) Ltd.,
209/2 Sanpavuth-Bangna Road Prakanong, BANGKOK 10260,
Tel. +66 2 745 4090, Fax. +66 2 398 0793

Turkey: Yukari Dudullu, Org. San. Blg., 2.Cad. Nr. 28 81260 Umraniye,
ISTANBUL, Tel. +90 216 522 1500, Fax. +90 216 522 1813

Ukraine: PHILIPS UKRAINE, 4 Patrice Lumumba str., Building B, Floor 7,
252042 KIEV, Tel. +380 44 264 2776, Fax. +380 44 268 0461

United Kingdom: Philips Semiconductors Ltd., 276 Bath Road, Hayes,
MIDDLESEX UB3 5BX, Tel. +44 208 730 5000, Fax. +44 208 754 8421

United States: 811 East Arques Avenue, SUNNYVALE, CA 94088-3409,
Tel. +1 800 234 7381, Fax. +1 800 943 0087

Uruguay: see South America

Vietnam: see Singapore

Yugoslavia: PHILIPS, Trg N. Pasica 5/v, 11000 BEOGRAD,
Tel. +381 11 62 5344, Fax.+381 11 63 5777

For all other countries apply to: Philips Semiconductors,
International Marketing & Sales Communications, Building BE-p, P.O. Box 218,
5600 MD EINDHOVEN, The Netherlands, Fax. +31 40 27 24825

Internet: <http://www.semiconductors.philips.com>

© Philips Electronics N.V. 1999

SCA 68

All rights are reserved. Reproduction in whole or in part is prohibited without the prior written consent of the copyright owner.

The information presented in this document does not form part of any quotation or contract, is believed to be accurate and reliable and may be changed without notice. No liability will be accepted by the publisher for any consequence of its use. Publication thereof does not convey nor imply any license under patent- or other industrial or intellectual property rights.

Printed in The Netherlands

545006/25/01/pp44

Date of release: 1999 Sep 27

Document order number: 9397 750 04816

Let's make things better.

Philips
Semiconductors



PHILIPS