

Dual general-purpose operational amplifier

NE/SA/SE4558

DESCRIPTION

The 4558 is a dual operational amplifier that is internally compensated. Excellent channel separation allows the use of a dual device in a single amp application, providing the highest packaging density. The NE/SA/SE4558 is a pin-for-pin replacement for the RC/RM/RV4558.

FEATURES

- 2MHz unity gain bandwidth guaranteed
- Supply voltage $\pm 22V$ for SE4558 and $\pm 18V$ for NE4558
- Short-circuit protection
- No frequency compensation required
- No latch-up
- Large common-mode and differential voltage ranges
- Low power consumption

PIN CONFIGURATIONS

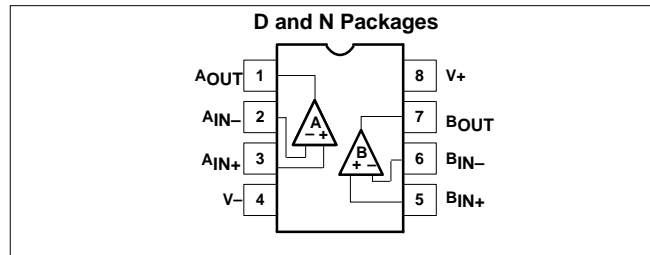

ORDERING INFORMATION

DESCRIPTION	TEMPERATURE RANGE	ORDER CODE	DWG #
8-Pin Plastic Small Outline (SO) Package	0 to +70°C	NE4558D	0174C
8-Pin Plastic Dual In-Line Package (DIP)	0 to +70°C	NE4558N	0404B
8-Pin Plastic Dual In-Line Package (DIP)	-40 to +85°C	SA4558N	0404B
8-Pin Plastic Dual In-Line Package (DIP)	-40 to +85°C	SA4558D	0404B
8-Pin Plastic Dual In-Line Package (DIP)	-55 to +125°C	SE4558N	0404B

EQUIVALENT SCHEMATIC

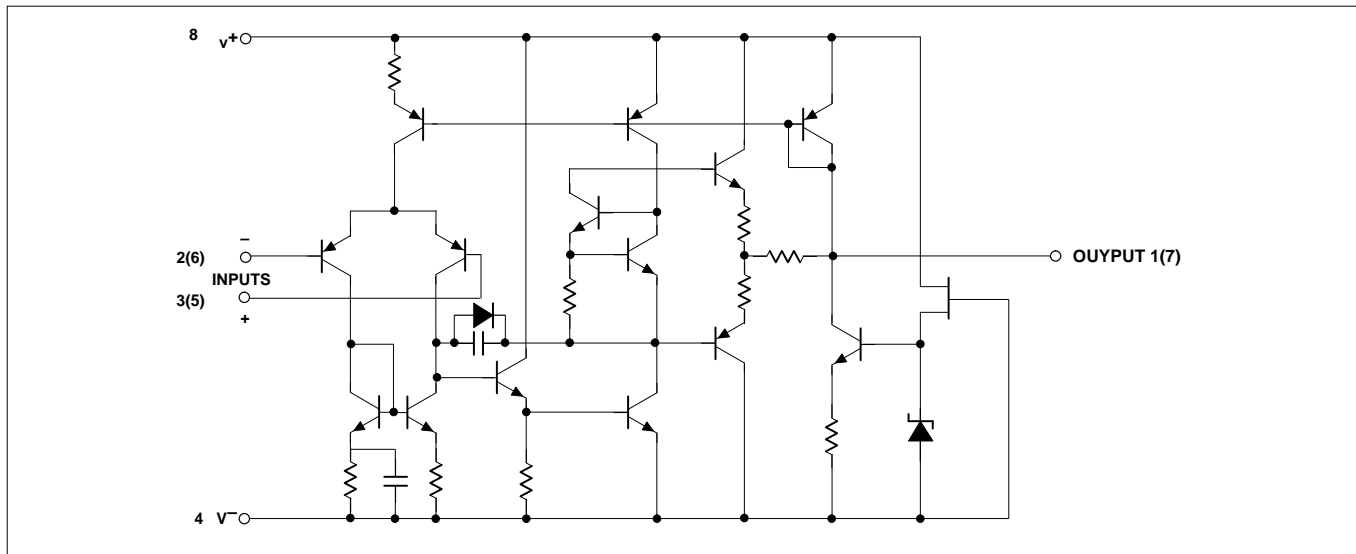

Dual general-purpose operational amplifier

NE/SA/SE4558

ABSOLUTE MAXIMUM RATINGS

SYMBOL	PARAMETER	RATING	UNIT
V _{CC}	Supply voltage		
	SE4558	±22	V
	NE4558, SA4558	±18	V
P _{D MAX}	Maximum power dissipation,		
	T _A =25°C (Still air) ¹		
	N package	1160	mW
	D package	780	mW
	Differential input voltage	±30	V
V _{IN}	Input voltage ²	±15	V
T _{STG}	Storage temperature range	-65 to +150	°C
T _A	Operating ambient temperature range		
	SE4558	-55 to +125	°C
	SA4558	-40 to +85	°C
	NE4558	0 to +70	°C
T _{SOLD}	Lead soldering temperature (10sec max)	300	°C
	Output short-circuit duration ³	Indefinite	

NOTES:

- Derate above 25°C at the following rates:
N package at 9.3mW/°C
D package at 6.2mW/°C
- For supply voltages less than ±15V, the absolute maximum input voltage is equal to the supply voltage.
- Short-circuit may be to ground on one amp only. Rating applies to +125°C case temperature or +75°C ambient temperature for NE4558 and to +85°C ambient temperature for SA4558.

DC ELECTRICAL CHARACTERISTICS

V_{CC}=+15V, T_A= 25°C unless otherwise specified.

SYMBOL	PARAMETER	TEST CONDITIONS	SE4558			SA/NE4558			UNIT
			Min	Typ	Max	Min	Typ	Max	
V _{OS}	Input offset voltage	R _S ≤10kΩ		1.0	5.0		2.0	6.0	mV
	ΔV _{OS} /ΔT	Over temp.		4			4		μV/°C
I _{OS}	Input offset current			50	200		30	200	nA
	ΔI _{OS} /ΔT	Over temp.		20			20		pA/°C
I _{BIAS}	Input bias current			40	500		200	500	nA
	ΔI _B /ΔT	Over temp.		40			40		pA/°C
R _{IN}	Input resistance		0.3	1.0		0.3	1.0	MΩ	
A _V	Large-signal voltage gain	R _L ≥2kΩ V _{OUT} =±10V	50,00 0	300,0 00		20,00 0	300,0 00		V/V
	Output voltage swing	R _L ≥10kΩ R _L ≥2kΩ	±12 ±10	±14 ±13		±12 ±10	±14 ±13		V V
V _{IN}	Input voltage range		±12	±13		±12	±13		V
CMRR	Common-mode rejection ratio	R _S ≤10kΩ	70	100		70	100		dB
PSRR	Power supply rejection ratio	R _S ≤10kΩ		10	150		10	150	μV/V
I _{SC}	Short-circuit current		5	25	60	5	25	60	mA
	Power consumption (all amplifiers)	R _L =∞		120	170		120	170	mW

Dual general-purpose operational amplifier

NE/SA/SE4558

DC ELECTRICAL CHARACTERISTICS (Continued)

SYMBOL	PARAMETER	TEST CONDITIONS	SE4558			SA/NE4558			UNIT
			Min	Typ	Max	Min	Typ	Max	
t_R	Transient response (unity gain)	$V_{IN}=20mV$ $R_L=2k\Omega$ $C_L\leq 100pF$							
	Rise time			100			100		ns
	Overshoot			15.0			15.0		%
SR	Slew rate (unity gain)	$R_L\geq 2k\Omega$		1.0			1.0		V/ μs
	Channel separation (gain=100)	$f=10kHz$ $R_S=1k\Omega$		90			90		dB
GBW	Unity gain bandwidth (gain=1)		2.0	3.0		2.0	3.0		MHz
θ_M	Phase margin			45			45		De- gree
V_{NOISE}	Input noise voltage	$f=1k\Omega$		25			25		nV/ \sqrt{Hz}
NOTE: The following specifications apply over operating temperature range.									
V_{OS}	Input offset voltage	$R_S\leq 10k\Omega$			6.0			7.5	mV
I_{OS}	Input offset current				500			300/500 ¹	nA
I_{BIAS}	Input bias current				1500			800/1500 1	nA
A_V	Large-signal voltage gain	$R_L\geq 2k\Omega$ $V_{OUT}=\pm 10V$	25,000			15,000			V/V
	Output voltage swing	$R_L\geq 2k\Omega$	± 10			± 10			V
P_C	Power consumption	$T_A=HIGH$ $T_A=LOW$		105	150		115	150	mW
				125	200		120	200	mW

NOTES:

- SA4558 only.

Dual general-purpose operational amplifier

NE/SA/SE4558

TYPICAL PERFORMANCE CURVES

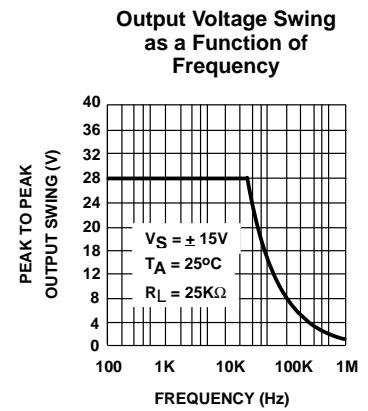
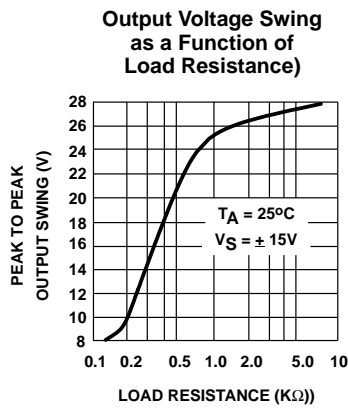
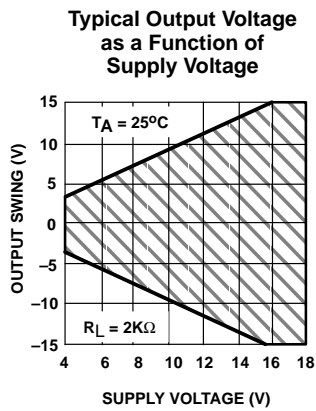
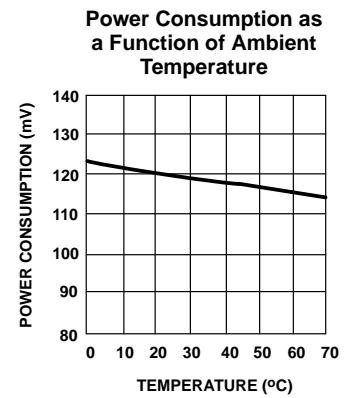
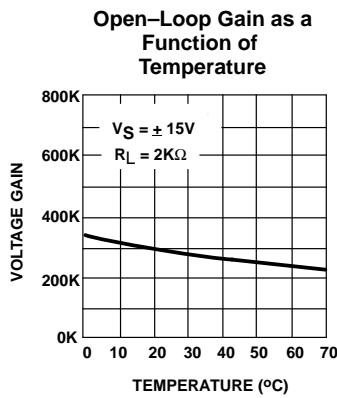
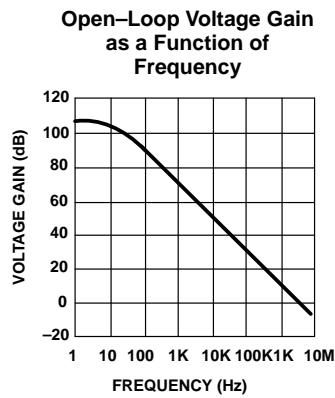
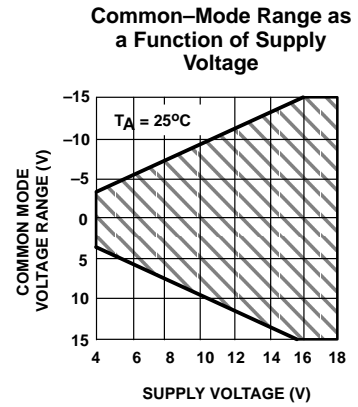
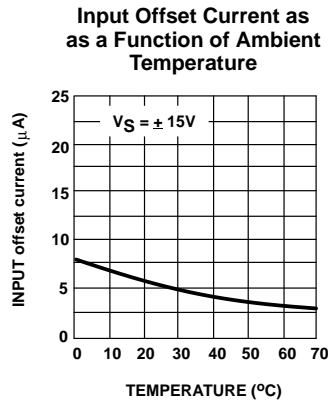
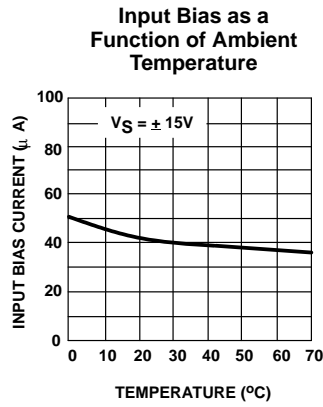

Dual general-purpose operational amplifier

NE/SA/SE4558

TYPICAL PERFORMANCE CURVES (Continued)

Quiescent Current as a Function of Supply Voltage

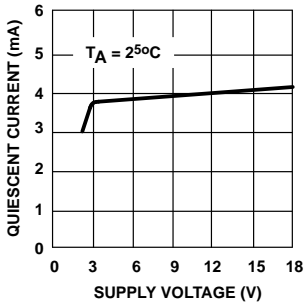

Transient Response

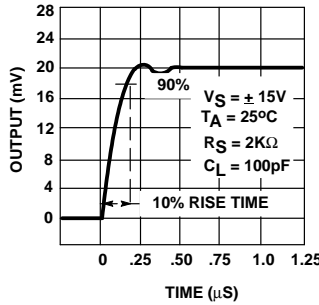

Voltage-Follower Large-Signal Pulse Response

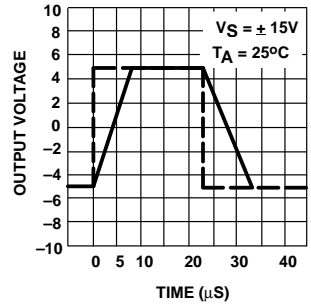

Input Noise Voltage as a Function of Frequency

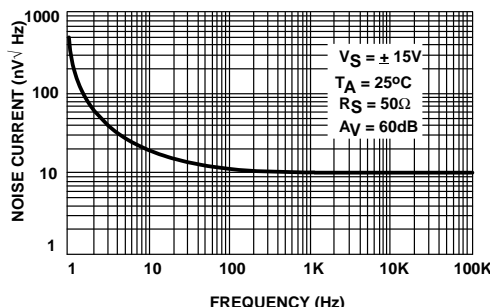

Input Noise Current as a Function of Frequency

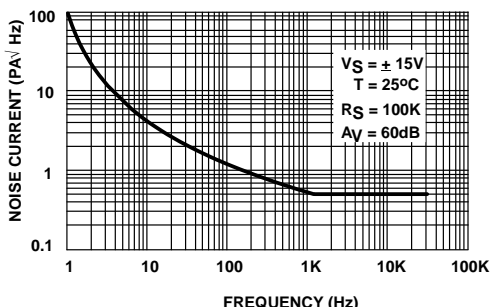

Channel Separation

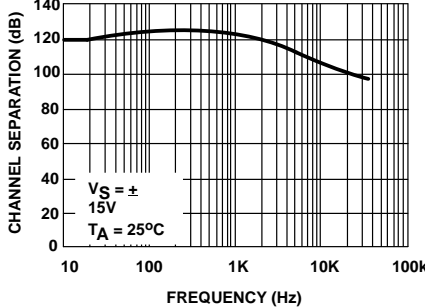

Total Harmonic Distortion vs Output Voltage

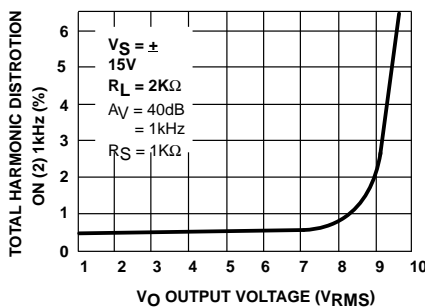

Distortion vs Frequency
 $V_O = 1V_{\text{RMS}}$

