

**MOSMIC<sup>®</sup> for TV-Tuner Prestage with 12 V Supply Voltage**

MOSMIC – MOS Monolithic Integrated Circuit

Electrostatic sensitive device.  
Observe precautions for handling.



**Applications**

Low noise gain controlled input stages in UHF- and VHF-tuner with 12 V supply voltage.

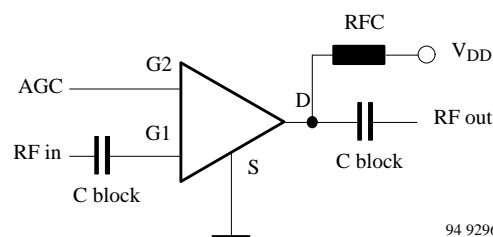

94 9296

**Features**

- Integrated gate protection diodes
- Low noise figure
- High gain
- Biasing network on chip
- Improved cross modulation at gain reduction
- High AGC-range
- SMD package

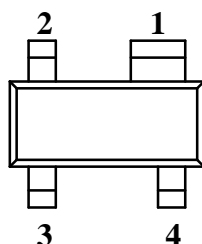

94 9279

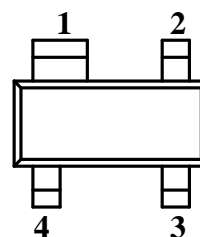

94 9278

S849T Marking: 849  
Plastic case (SOT 143)  
1 = Source; 2 = Drain; 3 = Gate 2; 4 = Gate 1

S849TR Marking: 49 R  
Plastic case (SOT 143R)  
1 = Source; 2 = Drain; 3 = Gate 2; 4 = Gate 1

**Absolute Maximum Ratings**

Parameters	Symbol	Value	Unit
Drain source voltage	$V_{DS}$	16	V
Drain current	$I_D$	30	mA
Gate 1/gate 2-source peak current	$\pm I_{G1/G2SM}$	10	mA
Gate 1/gate 2-source voltage	$\pm V_{G1/G2SM}$	7.5	V
Total power dissipation $T_{amb} \leq 60^\circ C$	$P_{tot}$	200	mW
Channel temperature	$T_{Ch}$	150	$^\circ C$
Storage temperature range	$T_{stg}$	-55 to +150	$^\circ C$

## Maximum Thermal Resistance

Parameters	Symbol	Maximum	Unit
Channel ambient on glass fibre printed board (25 x 20 x 1.5) mm <sup>3</sup> plated with 35 μm Cu	R <sub>thChA</sub>	450	K/W

## Electrical DC Characteristics

T<sub>amb</sub> = 25°C

Parameters / Test Conditions	Symbol	Min.	Typ.	Max.	Unit
Gate 1-source breakdown voltage ±I <sub>G1S</sub> = 10 mA, V <sub>G2S</sub> = V <sub>DS</sub> = 0	±V <sub>(BR)G1SS</sub>	8		12	V
Gate 2-source breakdown voltage ±I <sub>G2S</sub> = 10 mA, V <sub>G1S</sub> = V <sub>DS</sub> = 0	±V <sub>(BR)G2SS</sub>	8		12	V
Gate 1-source leakage current +V <sub>G1S</sub> = 6 V, V <sub>G2S</sub> = V <sub>DS</sub> = 0	+I <sub>G1SS</sub>			60	μA
Gate 1-source leakage current -V <sub>G1S</sub> = 6 V, V <sub>G2S</sub> = V <sub>DS</sub> = 0	-I <sub>G1SS</sub>			120	μA
Gate 2-source leakage current ±V <sub>G2S</sub> = 6 V, V <sub>G1S</sub> = V <sub>DS</sub> = 0	±I <sub>G2SS</sub>			20	nA
Drain current V <sub>DS</sub> = 12 V, V <sub>G1S</sub> = 0, V <sub>G2S</sub> = 6 V	I <sub>DSS</sub>	50		500	μA
Self-biased operating current V <sub>DS</sub> = 12 V, V <sub>G1S</sub> = nc, V <sub>G2S</sub> = 6 V	I <sub>DSP</sub>	8	12	16	mA
Gate 2-source cut-off voltage V <sub>DS</sub> = 12 V, V <sub>G1S</sub> = nc, I <sub>D</sub> = 200 μA	V <sub>G2S(OFF)</sub>		1.0		V

## Electrical AC Characteristics

V<sub>DS</sub> = 12 V, V<sub>G2S</sub> = 6 V, f = 1 MHz, T<sub>amb</sub> = 25°C

Parameters / Test Conditions	Symbol	Min.	Typ.	Max.	Unit
Forward transadmittance	y <sub>21s</sub>	20	24	28	mS
Gate 1 input capacitance	C <sub>issg1</sub>		2.1	2.5	pF
Feedback capacitance	C <sub>rss</sub>		20		fF
Output capacitance	C <sub>oss</sub>		0.9		pF
Power gain g <sub>S</sub> = 2 mS, g <sub>L</sub> = 0.5 mS, f = 200 MHz	G <sub>ps</sub>		26		dB
g <sub>S</sub> = 3.3 mS, g <sub>L</sub> = 1 mS, f = 800 MHz	G <sub>ps</sub>	16.5	20		dB
AGC range V <sub>DS</sub> = 12 V, V <sub>G2S</sub> = 1 V to 6 V, f = 800 MHz	ΔG <sub>ps</sub>	40			dB
Noise figure g <sub>S</sub> = 2 mS, g <sub>L</sub> = 0.5 mS, f = 200 MHz	F		1		dB
g <sub>S</sub> = 3.3 mS, g <sub>L</sub> = 1 mS, f = 800 MHz	F		1.3		dB

## Caution for Gate 1 switch-off mode:

No external DC-voltage on Gate 1 in active mode!

Switch-off at Gate 1 with V<sub>G1S</sub> < 0.7 V is feasible.

Using open collector switching transistor (inside of PLL), insert 10 kΩ collector resistor.

## Common Source S-Parameters

$V_{DS} = 12\text{ V}$ ;  $V_{G2S} = 6\text{ V}$

f/MHz	S <sub>11</sub>		S <sub>21</sub>		S <sub>12</sub>		S <sub>22</sub>	
	LOG MAG	ANG	LOG MAG	ANG	LOG MAG	ANG	LOG MAG	ANG
	dB	deg	dB	deg	dB	deg	dB	deg
50	-0.01	-3.9	7.46	175.0	-61.64	87.7	-0.17	-1.7
100	-0.04	-7.6	7.37	169.3	-55.58	85.2	-0.20	-3.3
150	-0.11	-11.5	7.30	163.4	-52.05	82.0	-0.22	-5.0
200	-0.16	-15.1	7.21	157.8	-49.78	79.5	-0.25	-6.6
250	-0.28	-19.1	7.09	151.8	-48.15	76.4	-0.26	-8.4
300	-0.39	-22.4	6.98	146.8	-46.79	75.0	-0.31	-9.8
350	-0.51	-26.0	6.79	141.2	-45.92	72.6	-0.34	-11.3
400	-0.65	-29.4	6.66	136.0	-45.15	70.9	-0.38	-12.8
450	-0.79	-32.7	6.47	131.0	-44.66	69.5	-0.44	-14.3
500	-0.95	-35.8	6.29	125.8	-44.28	67.8	-0.48	-15.9
550	-1.09	-39.0	6.13	121.0	-44.13	67.3	-0.53	-17.4
600	-1.26	-42.2	5.91	116.0	-44.04	68.0	-0.59	-18.8
650	-1.41	-45.1	5.76	111.8	-43.84	68.6	-0.63	-20.2
700	-1.56	-48.3	5.55	106.9	-43.97	69.2	-0.65	-21.6
750	-1.71	-50.9	5.40	102.6	-44.18	70.4	-0.72	-23.1
800	-1.89	-53.6	5.22	98.0	-44.54	73.2	-0.76	-24.4
850	-2.02	-56.7	5.08	93.8	-44.81	77.0	-0.81	-25.9
900	-2.15	-59.5	4.89	89.4	-45.03	83.4	-0.85	-27.6
950	-2.28	-62.3	4.75	85.2	-44.87	90.8	-0.90	-29.0
1000	-2.45	-65.1	4.55	80.9	-44.59	95.7	-0.96	-30.2
1050	-2.59	-67.8	4.38	76.2	-44.59	100.2	-1.07	-31.6
1100	-2.75	-70.5	4.20	72.2	-44.54	108.4	-1.11	-33.0
1150	-2.81	-73.3	4.14	67.9	-44.05	116.7	-1.13	-34.7
1200	-2.96	-75.7	4.02	64.3	-43.33	125.5	-1.15	-36.2
1250	-3.07	-78.7	3.90	60.1	-42.41	133.5	-1.18	-37.6
1300	-3.18	-81.4	3.73	55.6	-41.13	139.3	-1.26	-39.1

## Typical Characteristics (T<sub>j</sub> = 25°C unless otherwise specified)

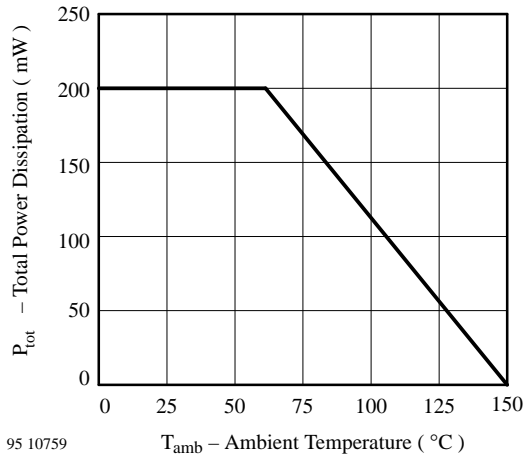

Figure 1. Total Power Dissipation vs. Ambient Temperature

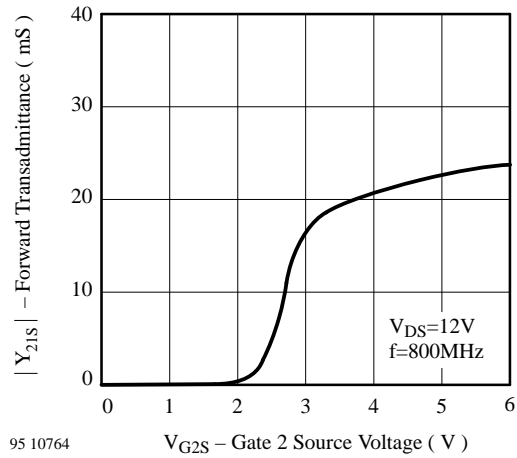

Figure 4. Forward Transadmittance vs. Gate 2 Source Voltage

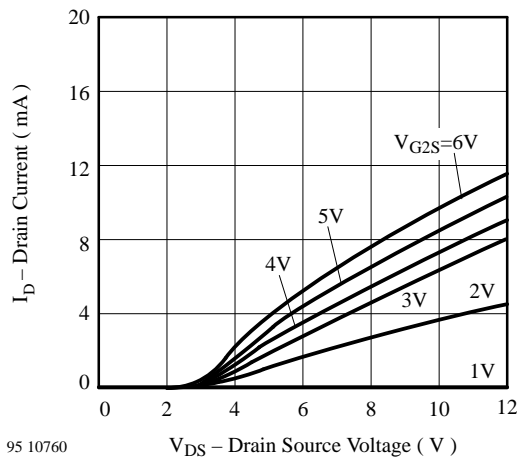

Figure 2. Drain Current vs. Drain Source Voltage

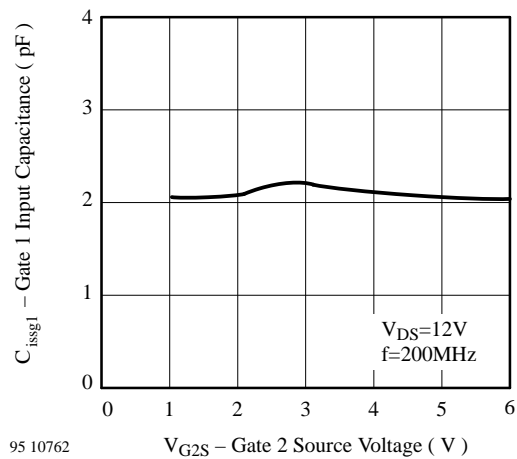

Figure 5. Gate 1 Input Capacitance vs. Gate 2 Source Voltage

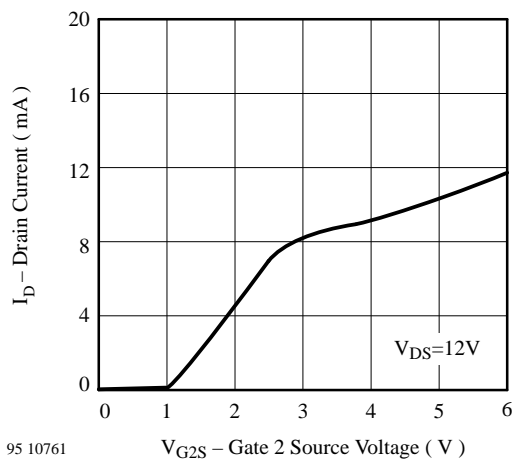

Figure 3. Drain Current vs. Gate 2 Source Voltage

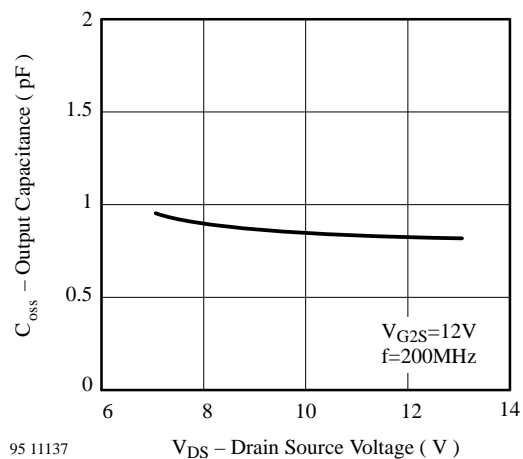

Figure 6. Output Capacitance vs. Drain Source Voltage

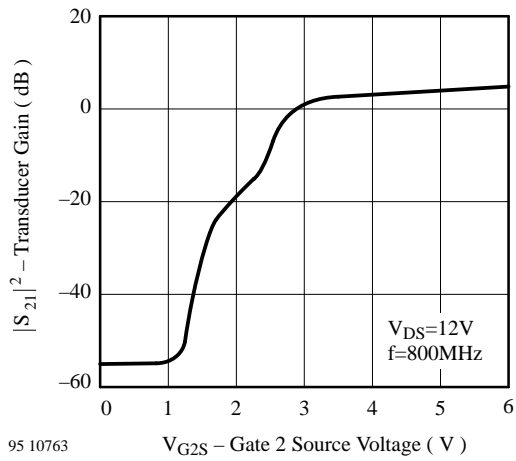

Figure 7. Transducer Gain vs. Gate 2 Source Voltage

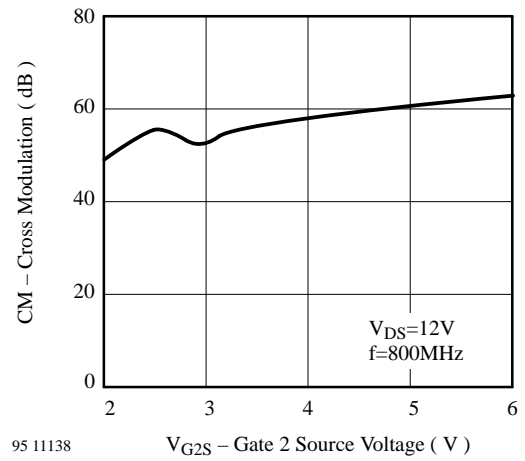
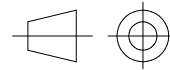
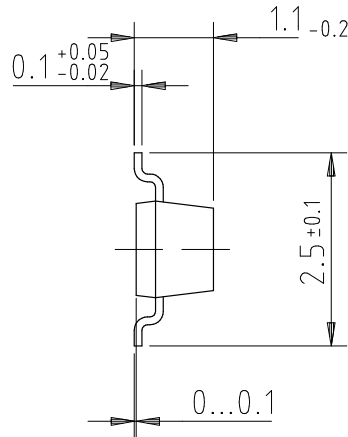
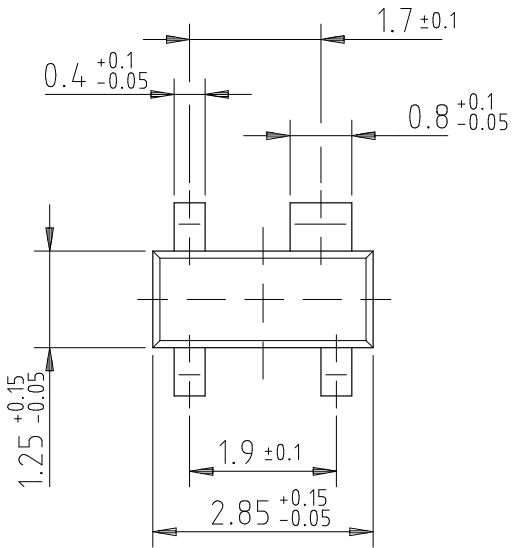

Figure 8. Cross Modulation vs. Gate 2 Source Voltage

## Dimensions of S849T in mm



96 12240

technical drawings  
according to DIN  
specifications

## Dimensions of S849TR in mm

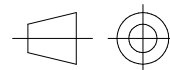
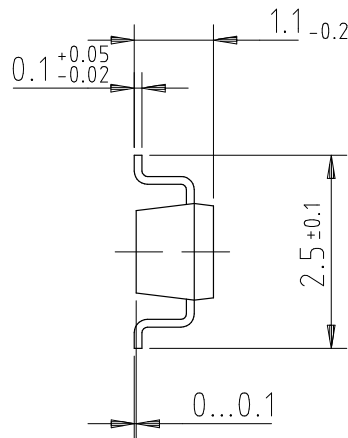
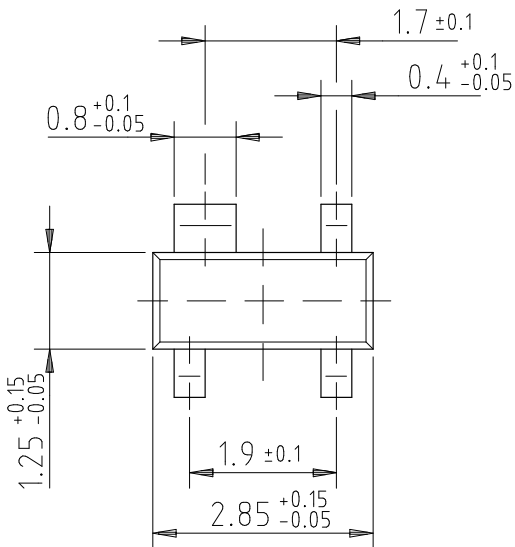

96 12239

technical drawings  
according to DIN  
specifications

## Ozone Depleting Substances Policy Statement

It is the policy of **TEMIC TELEFUNKEN microelectronic GmbH** to

1. Meet all present and future national and international statutory requirements.
2. Regularly and continuously improve the performance of our products, processes, distribution and operating systems with respect to their impact on the health and safety of our employees and the public, as well as their impact on the environment.

It is particular concern to control or eliminate releases of those substances into the atmosphere which are known as ozone depleting substances (ODSs).

The Montreal Protocol (1987) and its London Amendments (1990) intend to severely restrict the use of ODSs and forbid their use within the next ten years. Various national and international initiatives are pressing for an earlier ban on these substances.

**TEMIC TELEFUNKEN microelectronic GmbH** semiconductor division has been able to use its policy of continuous improvements to eliminate the use of ODSs listed in the following documents.

1. Annex A, B and list of transitional substances of the Montreal Protocol and the London Amendments respectively
2. Class I and II ozone depleting substances in the Clean Air Act Amendments of 1990 by the Environmental Protection Agency (EPA) in the USA
3. Council Decision 88/540/EEC and 91/690/EEC Annex A, B and C (transitional substances) respectively.

**TEMIC** can certify that our semiconductors are not manufactured with ozone depleting substances and do not contain such substances.

**We reserve the right to make changes to improve technical design and may do so without further notice.**

Parameters can vary in different applications. All operating parameters must be validated for each customer application by the customer. Should the buyer use TEMIC products for any unintended or unauthorized application, the buyer shall indemnify TEMIC against all claims, costs, damages, and expenses, arising out of, directly or indirectly, any claim of personal damage, injury or death associated with such unintended or unauthorized use.

TEMIC TELEFUNKEN microelectronic GmbH, P.O.B. 3535, D-74025 Heilbronn, Germany  
Telephone: 49 (0)7131 67 2831, Fax number: 49 (0)7131 67 2423