

Ordering number: EN1704B

SANYO	No.1704B	CMOS LSI
		LC5732, 5732H
4-Bit Microcomputer with LCD Driver		

Overview

The LC5732, 5732H are CMOS 4-bit microcomputers that operate on low voltage, very low current and contain LCD drivers. They also contain a 4-bit parallel processing ALU, a program memory ROM, many LCD segment outputs, a prescaler, an oscillator.
 The LC5732 is especially suited for use in high-grade timepieces, time controllers, electronic calculators, LCD games with timepiece. The LC5732H is especially suited for use in audio equipment, copiers, facsimiles with LCD and sub CPU applications.

Hardware Features

- Supply voltage
 LC5732 : 1.5V or 3.0V typ. (mask option-selectable)
 LC5732H : 5.0V typ.
- Very low current dissipation
 LC5732 : 3.0 μ A typ. (Ag battery version, 32kHz crystal oscillation, during timekeeping operation)
 1.5 μ A typ. (Li battery version, 32kHz crystal oscillation, during timekeeping operation)
 LC5732H : 10.0 μ A typ. (32kHz crystal oscillation, during HALT mode)
- LC5732 : Crystal oscillation for timekeeping (32.768kHz crystal connected externally) or CR oscillator
- LC5732H : Crystal oscillation for timekeeping (32.768kHz crystal connected externally), CR oscillator, or CF oscillator
- Many output pins for LCD panel drive (27 pins)

Drivable LCD panel		Number of drivable LCD segments
1/2 bias	1/3 duty	81 segments
1/2 bias	1/2 duty	54 segments
Static		27 segments

Continued on next page.

Package Dimensions 3057
(unit : mm)

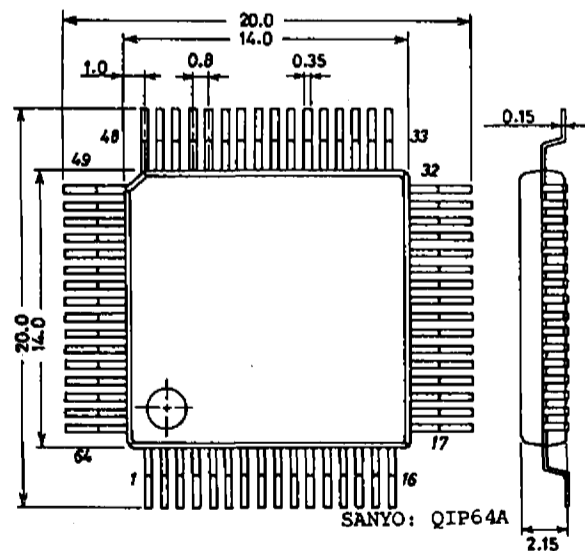

Package Dimensions 3026B
(unit : mm)

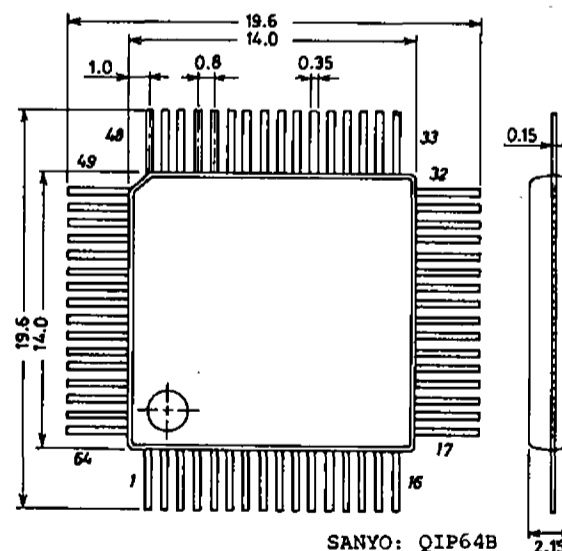

SANYO Electric Co., Ltd. Semiconductor Business Headquarters
 TOKYO OFFICE Tokyo Bldg., 1-10, 1 Chome, Ueno, Taito-ku, TOKYO, 110 JAPAN

12495TH (KOTO)/3069TA/O244MY,TS No.1704-1/14

LC5732, 5732H

Continued from preceding page.

- On-chip melody function : 3 octaves (The melody length is software-controlled. One musical note requires one byte.)
- Input/output pins
 - Number of inputs : 8
 - Control output pins : 3 pins (Output dedicated to alarm : 2 pins, general-purpose output : 1 pin)
- Possible to use LCD panel drive output pins as output-only ports (mask option-selectable)
- ROM : 2048×8 bits
- RAM : 48×4 bits
- Cycle time
 - LC5732 : 60 μ s. CR oscillation 65kHz (122 μ s. for 32.768kHz crystal)
 - LC5732H : 10 μ s. (400kHz 5V \pm 10%)
- On-chip step-up circuit/step-down circuit
- Shipping style : When using solder dip or spray techniques to mount QFP64, QFP or chip products on a printed circuit board, please consult your Sanyo sales or technical representative in advance concerning the process conditions to be used.

Software Features

- Powerful instruction set : 92 instructions
- Table read instruction
- 1-level subroutine nesting
- On-chip 15-bit divider for timekeeping (delivers an overflow signal every 64ms/100ms/500ms when a 32.768kHz crystal is used.)
- HALT function

Application Development Support System

- Evaluation chip (LC5796) is available for application development and the dedicated equipment is available as the application development tools.
- Application development tools
 - (A) MS-DOS personal computer
 - (B) Cross assembler : LC5732. EXE
 - (C) Mask option programmer : SU5732. EXE
- EVA-520 + TB-5734 + DCB-1 (Rev 2.0V or greater) + Application evaluation board + LC5796
By connecting to the MS-DOS machine, application development program data correction and debugging may be done.
- TB-5734 + DCB-1 (Rev 2.0V or greater) + Application evaluation board + LC5796
By using the EPROM (2732) with application development program data written in, mounting evaluation may be done.

Note 1 · The application evaluation board is constructed by the user.

- LEDs or LCDs may be used for display.
- The EVA-520 is a modified version of the EVA-410 whose monitor ROM is replaced by the SCR-5734.

Note 2 · Since the evaluation chip LC5796 and the LC5732, 5732H differ in RAM capacity, check the ROM capacity when developing or debugging programs.

LC5732, 5732H : 48×4 bits
LC5796 : 256×4 bits

- If the DPH value on a program is other than 0, 1, 2, the LC5732, 5732H will malfunction in actual applications.
- When developing programs, take care of the DPH value. The usable DPH values are "0", "1", "2" only.
- We will be free from any blame even if you use DPH = other than 0 to 2 to develop programs.

LC5732, 5732H

Equivalent Circuit Block Diagram

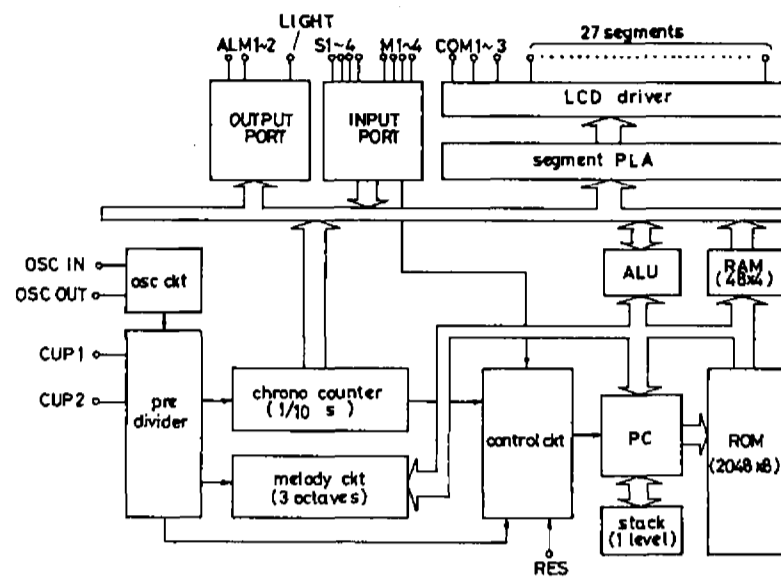

Pad Assignment of LSI Chip

Chip size : 4.61mm × 3.54mm
 Chip thickness : 480μm
 Pad size : 120μm × 120μm

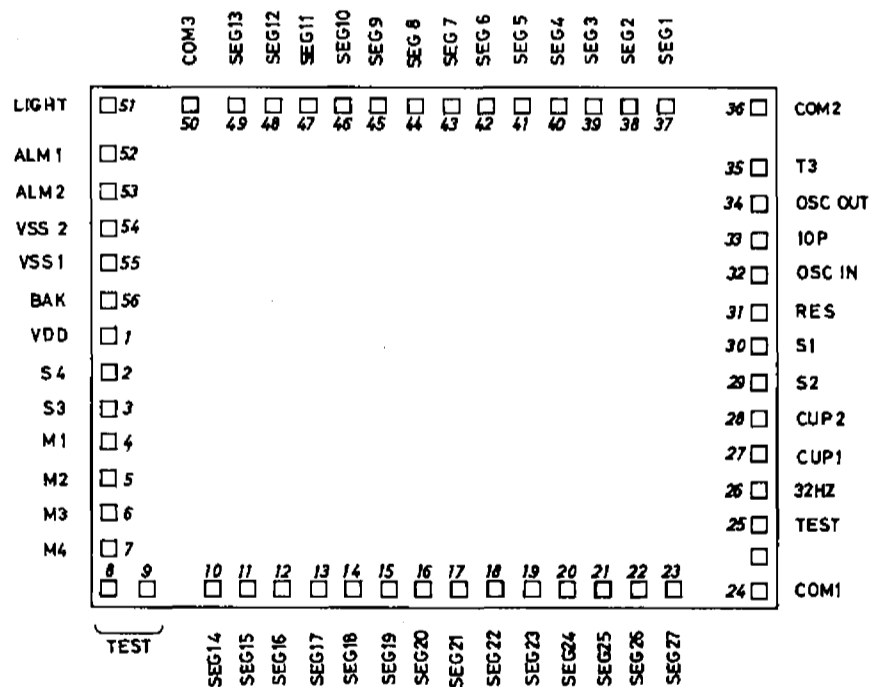

(Note) SEG14 to SEG27 can be used for output ports. (mask option-selectable)

LC5732, 5732H

Pad Name and Coordinates

QFP 64 Pin Description				
	Pad No.	Pin Name	X (μm)	Y (μm)
56	1	V _{DD}	-2155	75
57	2	S4	∕	-165
58	3	S3	∕	-405
59	4	M1	∕	-645
60	5	M2	∕	-885
61	6	M3	∕	-1125
62	7	M4	∕	-1365
64	8	TEST	∕	-1620
1	9	TEST	-1915	∕
2	10	SEG14	-1465	∕
3	11	SEG15	-1230	∕
4	12	SEG16	-995	∕
5	13	SEG17	-760	∕
6	14	SEG18	-525	∕
7	15	SEG19	-290	∕
8	16	SEG20	-55	∕
9	17	SEG21	180	∕
10	18	SEG22	410	∕
11	19	SEG23	645	∕
12	20	SEG24	880	∕
13	21	SEG25	1115	∕
14	22	SEG26	1350	∕
15	23	SEG27	1585	∕
19	24	COM1	2155	∕
20	25	TEST	∕	-1190
21	26	32Hz	∕	-950
22	27	CUP1	∕	-710
23	28	CUP2	∕	-470

QFP 64 Pin Description				
	Pad No.	Pin Name	X (μm)	Y (μm)
25	29	S2	2155	-230
26	30	S1	∕	10
27	31	RES	∕	250
28	32	OSCIN	∕	490
29	33	10P	∕	730
30	34	OSCOU	∕	970
31	35	T3	∕	1210
32	36	COM2	∕	1620
34	37	SEG1	1530	∕
35	38	SEG2	1295	∕
36	39	SEG3	1060	∕
37	40	SEG4	825	∕
38	41	SEG5	595	∕
39	42	SEG6	360	∕
40	43	SEG7	125	∕
41	44	SEG8	-110	∕
42	45	SEG9	-355	∕
43	46	SEG10	-585	∕
44	47	SEG11	-820	∕
45	48	SEG12	-1055	∕
46	49	SEG13	-1290	∕
47	50	COM3	-1615	∕
50	51	LIGHT	-2155	∕
51	52	ALM1	∕	1275
52	53	ALM2	∕	1035
53	54	V _{SS2}	∕	795
54	55	V _{SS1}	∕	555
55	56	BAK	∕	315

- The pad coordinates are such that the chip center is taken as the origin and the values for (X, Y) represent the coordinates of the center point of each pad.
- Pin 24 of the QFP64 is connected to the substrate of the LSI.
- Pins 16, 17, 18, 33, 48, 49, 63 are NC pins.
- The substrate, NC pins must not be connected externally.
- When using solder dip or spray techniques to mount QFP64 package products on a printed circuit board, please consult your Sanyo sales or technical representative in advance concerning the process conditions to be used.

Pin Functions

Pad No.	Pin Name	Input/Output	Circuit Configuration	Function
32	OSCIN	Input		Crystal OSC mode 32.768kHz crystal is connected across OSCIN and OSCOUT for oscillation. Used as reference clock for timepiece and system clock.
34	OSCOU	Output		CR OSC mode R and C are connected across OSCIN and OSCOUT for oscillation. Used as system clock. Ceramic resonator OSC mode (LC5732H only) Ceramic resonator and R are connected across OSCIN and OSCOUT and C is connected across OSCIN, OSCOUT and V _{DD} for oscillation.

Continued on next page.

LC5732, 5732H

Continued from preceding page.

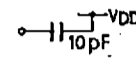
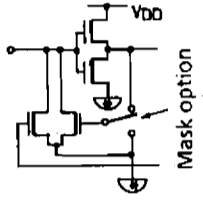
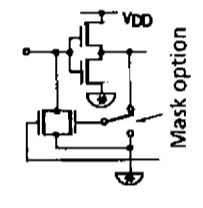
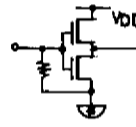
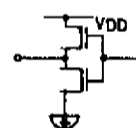
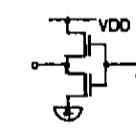
Pad No.	Pin Name	Input/Output	Circuit Configuration	Function
33	10P	-		Connected to OSCOUT and used as OSC phase compensation capacitor.
30 29 3 2	S1 S2 S3 S4	Input		Input-only port. LSI system is reset by applying V _{DD} to S1 to S4 simultaneously.
4 5 6 7	M1 M2 M3 M4	Input		Input pins for placing data in RAM.
31	RES	Input		Input pin for resetting LSI system.
56	BAK			(-) power supply pin for logic unit inside the LSI. For Li battery version, a capacitor must be connected across BAK and V _{DD} to prevent logic unit from malfunctioning.
51	LIGHT	Output		Output-only pin Suited for delivering signal to drive transistor for light.
52 53	ALM1 ALM2	Output		Output-only pin Used to deliver *4kHz, 2kHz, 1kHz modulation signal with instruction. Also used to deliver non-modulation signal. Used to deliver melody signal of 3 octaves with instruction.
1	V _{DD}			(+) power supply pin.
54 55	V _{SS2} V _{SS1}			(-) power supply pin. Ag battery version, Li battery version, EXT-V version : mask option selectable. Also used as power supply for LCD drive. The following Table shows how to connect external parts in each case.

	Ag bat. use		Li bat. use		EXT-V use	
	static	1/2 bias	static	1/2 bias	static	1/2 bias
V _{DD}						
V _{SS1}						
V _{SS2}						

Continued on next page.

LC5732, 5732H

Continued from preceding page.

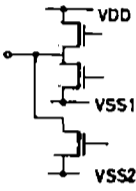
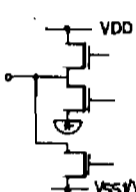
Pad No.	Pin Name	Input/Output	Circuit Configuration	Function																				
27 28	CUP1 CUP2			Pins for connecting voltage step-up (step-down) capacitor.																				
24 36 50	COM1 COM2 COM3	Output		<p>Output pins for LCD panel common plate. The following pin is used in each case.</p> <table border="1"> <thead> <tr> <th></th> <th>Static</th> <th>1/2 duty</th> <th>1/3 duty</th> </tr> </thead> <tbody> <tr> <td>COM1</td> <td>○</td> <td>○</td> <td>○</td> </tr> <tr> <td>COM2</td> <td>.</td> <td>○</td> <td>○</td> </tr> <tr> <td>COM3</td> <td>.</td> <td>.</td> <td>○</td> </tr> <tr> <td>Alternating frequency</td> <td>32Hz</td> <td>32Hz</td> <td>43Hz</td> </tr> </tbody> </table> <p>(Alternating frequency is for 32.768kHz crystal OSC application.)</p>		Static	1/2 duty	1/3 duty	COM1	○	○	○	COM2	.	○	○	COM3	.	.	○	Alternating frequency	32Hz	32Hz	43Hz
	Static	1/2 duty	1/3 duty																					
COM1	○	○	○																					
COM2	.	○	○																					
COM3	.	.	○																					
Alternating frequency	32Hz	32Hz	43Hz																					
19 to 23 37 to 49	Segment driver	Output		Output pins for LCD panel segments. Mask option permits Seg 14 to Seg 27 (pad No.10 to 23) to be used as output ports.																				
26 35 25 8 9	32Hz T3 TEST	Test		Test pins (not used by user)																				

(Note) For Ag battery power supply, \downarrow is connected to VSS1; for Li battery/EXT-V power supply, connected to VSS2.

* 4kHz, 2kHz, 1kHz : For 32.768kHz crystal OSC application, proportional to OSC frequency.

■ No products described or contained herein are intended for use in surgical implants, life-support systems, aerospace equipment, nuclear power control systems, vehicles, disaster/crime-prevention equipment and the like, the failure of which may directly or indirectly cause injury, death or property loss.

■ Anyone purchasing any products described or contained herein for an above-mentioned use shall:

- ① Accept full responsibility and indemnify and defend SANYO ELECTRIC CO., LTD., its affiliates, subsidiaries and distributors and all their officers and employees, jointly and severally, against any and all claims and litigation and all damages, cost and expenses associated with such use:
- ② Not impose any responsibility for any fault or negligence which may be cited in any such claim or litigation on SANYO ELECTRIC CO., LTD., its affiliates, subsidiaries and distributors or any of their officers and employees jointly or severally.

■ Information (including circuit diagrams and circuit parameters) herein is for example only; it is not guaranteed for volume production. SANYO believes information herein is accurate and reliable, but no guarantees are made or implied regarding its use or any infringements of intellectual property rights or other rights of third parties.

LC5732, 5732H

Sample Application Circuits

(1) Ag battery used application
(1/2 bias 1/3 duty) *: 4 segment outputs are used for output ports.

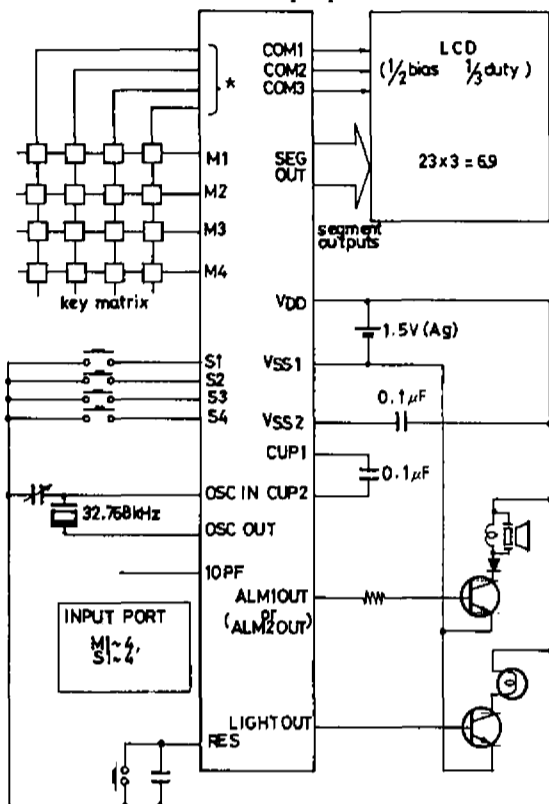

Crystal OSC (Power supply : Ag battery version)

(2) Li battery used application
(1/2 bias 1/3 duty) *: 4 segment outputs are used for output ports.

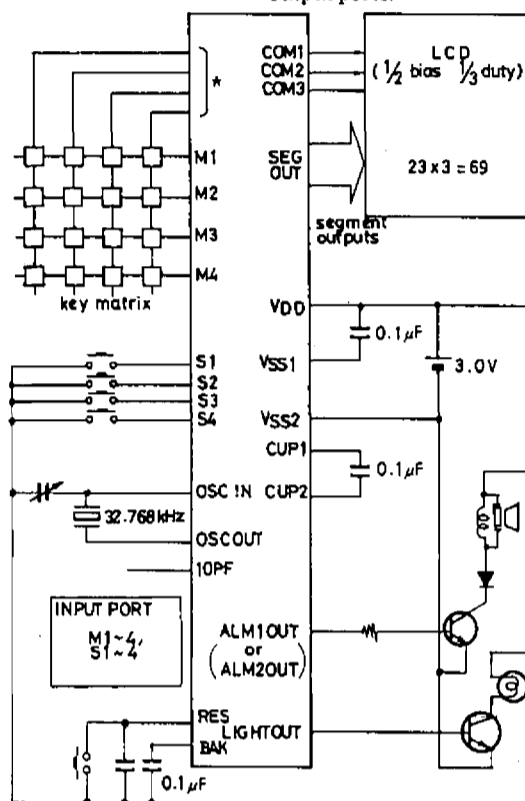

Crystal OSC (Power supply : Li battery version)

(3) EXT-V used application
(1/2 bias 1/3 duty) *: 4 segment outputs are used for output ports.

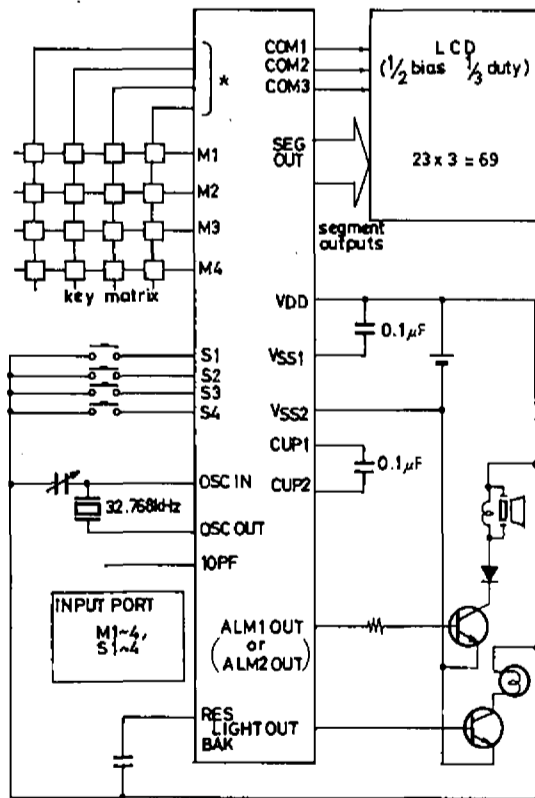

Crystal OSC (Power supply : EXT-V version)

LC5732, 5732H

● Ag Battery Version

Absolute Maximum Ratings at $T_a = 25 \pm 2^\circ\text{C}$, $V_{DD} = 0\text{V}$

			unit
Maximum Supply Voltage	V_{SS1}	-4.0 to +0.3	V
	V_{SS2}	-4.0 to +0.3	V
Maximum Input Voltage	V_{IN}	S1-4, M1-4, 32Hz, TEST, 10P, OSCIN, RES	$V_{SS1} - 0.3$ to 0.3 V
Maximum Output Voltage	V_{OUT1}	32Hz, CUP2, OSCOUT, ALM1, ALM2, LIGHT	$V_{SS1} - 0.3$ to 0.3 V
	V_{OUT2}	SEGOUT, COM1, COM2, COM3, CUP1	$V_{SS2} - 0.3$ to 0.3 V
Operating Temperature	T_{opr}	-10 to +65	$^\circ\text{C}$
Storage Temperature	T_{stg}	-30 to +125	$^\circ\text{C}$

Allowable Operating Conditions at $T_a = 25 \pm 2^\circ\text{C}$, $V_{DD} = 0\text{V}$

		min	typ	max	unit
Supply Voltage	V_{SS1}	-1.65		-1.30	V
	V_{SS2}	-3.3		-2.4	V
Input 'H'-Level Voltage	V_{IH}	-0.2		0	V
Input 'L'-Level Voltage	V_{IL}	V_{SS1}		$V_{SS1} + 0.2$	V
Operating Frequency	f_{opg1}	Ta = -10 to +65 $^\circ\text{C}$, crystal OSC		32	33 kHz
	f_{opg2}	Ta = -10 to +65 $^\circ\text{C}$, CR OSC		32.768	kHz

Electrical Characteristics at $T_a = 25 \pm 2^\circ\text{C}$, $V_{DD} = 0\text{V}$

		min	typ	max	unit
Input Resistance	R_{IN1A}	200		2000	k Ω
	R_{IN1B}	200		2000	k Ω
	R_{IN2}	10		300	k Ω
Output 'H'-Level Voltage	V_{OH1}	-0.2			V
Output 'L'-Level Voltage	V_{OL1}		$V_{SS2} + 0.2$		V
Output 'H'-Level Voltage	V_{OH2}	-0.2			V
Output 'M'-Level Voltage	V_{OM}	$V_{SS1} - 0.2$		$V_{SS1} + 0.2$	V
Output 'L'-Level Voltage	V_{OL2}		$V_{SS2} + 0.2$		V
Output 'H'-Level Voltage	V_{OH3}	-0.65			V
Output 'L'-Level Voltage	V_{OL3}		$V_{SS1} + 0.65$		V
Output 'H'-Level Voltage	V_{OH4}	-0.2			V
Output 'L'-Level Voltage	V_{OL4}		$V_{SS1} + 0.2$		V
Output Voltage	V_{SS2}	-3.3		-2.5	V
Current Dissipation	I_{DD}		2.0		μA
Oscillation Start Voltage	V_{stt}	-1.35			V
Oscillation Hold Voltage	V_{HOLD}	-1.65		-1.30	V
Oscillation Start Time	t_{stt}			10	s
Oscillation Compensation Capacitance	10P	8	10	12	pF

Notes for developing an LC5730 series microcomputer-used system

The low current dissipation is a distinctive feature of the LC5730 series microcomputers. However, it is not easy to determine the total current to be dissipated in an LC5730 series microcomputer-used system by actual measurement when you develop a software, because much current flows in the peripherals of the evaluation tools.

For a system which requires low current dissipation, check the current dissipation using an evaluation sample before mass-producing the system.

LC5732, 5732H

● Li Battery Version

Absolute Maximum Ratings at $T_a = 25 \pm 2^\circ\text{C}$, $V_{DD} = 0\text{V}$

			unit
Maximum Supply Voltage	V_{SS1}	-4.0 to +0.3	V
	V_{SS2}	-4.0 to +0.3	V
Maximum Input Voltage	V_{IN1}	10P, OSCIN, 32Hz	$V_{SS1} - 0.3$ to 0.3
	V_{IN2}	S1-4, M1-4, TEST, RES	$V_{SS2} - 0.3$ to 0.3
Maximum Output Voltage	V_{OUT1}	32Hz, CUP2, OSCOUT	$V_{SS1} - 0.3$ to 0.3
	V_{OUT2}	SEGOUT, COM1, COM2, COM3, CUP1, LIGHT, ALM1, ALM2	$V_{SS2} - 0.3$ to 0.3
Operating Temperature	T_{opr}	-10 to +65	$^\circ\text{C}$
Storage Temperature	T_{stg}	-30 to +125	$^\circ\text{C}$

Allowable Operating Conditions at $T_a = 25 \pm 2^\circ\text{C}$, $V_{DD} = 0\text{V}$

		min	typ	max	unit
Supply Voltage	V_{SS1}	-3.6		-1.3	V
	V_{SS2}	-3.6		-2.0	V
Input 'H'-Level Voltage	V_{IH}	-0.4		0	V
Input 'L'-Level Voltage	V_{IL}		V_{SS2}	$V_{SS2} + 0.4$	V
Operating Frequency	f_{opg1}		32	33	kHz

Electrical Characteristics at $T_a = 25 \pm 2^\circ\text{C}$, $V_{DD} = 0\text{V}$

		min	typ	max	unit
Input Resistance	R_{IN1A}	200		2000	k Ω
	R_{IN1B}	100		2000	k Ω
	R_{IN2}	10		300	k Ω
Output 'H'-Level Voltage	V_{OH1}	-0.2			V
Output 'L'-Level Voltage	V_{OL1}		$V_{SS2} + 0.2$		V
Output 'H'-Level Voltage	V_{OH2}	-0.2			V
Output 'M'-Level Voltage	V_{OM}	$V_{SS2}/2 - 0.2$		$V_{SS2}/2 + 0.2$	V
Output 'L'-Level Voltage	V_{OL2}		$V_{SS2} + 0.2$		V
Output 'H'-Level Voltage	V_{OH3}	-0.65			V
Output 'L'-Level Voltage	V_{OL3}		$V_{SS2} + 0.65$		V
Output 'H'-Level Voltage	V_{OH4}	-1.5			V
Output 'L'-Level Voltage	V_{OL4}		$V_{SS2} + 1.5$		V
Output 'H'-Level Voltage	V_{OH5}	-0.4			V
Output 'L'-Level Voltage	V_{OL5}		$V_{SS2} + 0.4$		V
Output Voltage (halver)	V_{SS1}			-1.35	V
Current Dissipation	I_{DD}		0.8	1.5	μA
Oscillation Start Voltage	V_{stt}	-1.35			V
Oscillation Hold Voltage	V_{HOLD}			-2.6	V
Oscillation Start Time	t_{stt}			10	s
Oscillation Compensation Capacitance	10P	8	10	12	pF

LC5732, 5732H

●EXT-V Version

Absolute Maximum Ratings at Ta = 25 ± 2°C, VDD = 0V

			unit
Maximum Supply Voltage	VSS1	-4.0 to +0.3	V
	VSS2	-4.0 to +0.3	V
Maximum Input Voltage	VIN	10P, OSCIN, 32Hz, S1-4, M1-4, TEST, RES	VSS2 - 0.3 to 0.3 V
Maximum Output Voltage	VOU	32Hz, CUP2, OSCOUT, SEGOUT, COM1, COM2, COM3, CUP1, LIGHT, ALM1, ALM2	VSS2 - 0.3 to 0.3 V
Operating Temperature	Topr		-30 to +70 °C
Storage Temperature	Tstg		-40 to +125 °C

Allowable Operating Conditions at Ta = 25 ± 2°C, VDD = 0V

			min	typ	max	unit
Supply Voltage	VSS1		-3.6		-1.3	V
	VSS2		-3.6		-2.0	V
Input 'H'-Level Voltage	VIH	S1-4, M1-4, RES	-0.4		0	V
Input 'L'-Level Voltage	VIL	S1-4, M1-4, RES	VSS2		VSS2 + 0.4	V
Operating Frequency	fopg1	Ta = -30 to +70°C, crystal OSC	32		33	kHz
	fopg2	Ta = -30 to +70°C, CR OSC	32.768			kHz

Electrical Characteristics at Ta = 25 ± 2°C, VDD = 0V

			min	typ	max	unit
Input Resistance	RIN1A	VSS2 = -2.9V, VIL = VSS2 + 0.4V, 'L' level hold tr., *1, Fig. 4	200		2000	kΩ
	RIN1B	VSS2 = -2.9V, 'L' level pull-in tr., *1, Fig. 4	100		2000	kΩ
	RIN3	VSS2 = -2.9V, TEST, RES	10		300	kΩ
Output 'H'-Level Voltage	VOH1	VSS2 = -2.9V, IOH = -0.4μA, *2	-0.2			V
Output 'L'-Level Voltage	VOL1	VSS2 = -2.9V, IOL = 0.4μA, *2			VSS2 + 0.2	V
Output 'H'-Level Voltage	VOH2	VSS2 = -2.9V, IOH = -4μA, COM1, COM2, COM3	-0.2			V
Output 'M'-Level Voltage	VOM	VSS2 = -2.9V, IOH = -4μA, IOL = 4μA, COM1, COM2, COM3	VSS2/2 - 0.2		VSS2/2 + 0.2	V
Output 'L'-Level Voltage	VOL2	VSS2 = -2.9V, IOL = 4μA, COM1, COM2, COM3			VSS2 + 0.2	V
Output 'H'-Level Voltage	VOH3	VSS2 = -2.4V, IOH = -250μA, ALM1, ALM2	-0.65			V
Output 'L'-Level Voltage	VOL3	VSS2 = -2.4V, IOL = 250μA, ALM1, ALM2			VSS2 + 0.65	V
Output 'H'-Level Voltage	VOH4	VSS2 = -2.4V, IOH = -150μA, LIGHT	-1.5			V
Output 'L'-Level Voltage	VOL4	VSS2 = -2.4V, IOL = 150μA, LIGHT			VSS2 + 1.5	V
Output 'H'-Level Voltage	VOH5	VSS2 = -2.9V, IOH = -40μA, *3	-0.4			V
Output 'L'-Level Voltage	VOL5	VSS2 = -2.9V, IOL = 40μA, *3			VSS2 + 0.4	V
Output Voltage (halver)	VSS1	VSS2 = -2.8V, C1 = C2 = 0.1μF, fopg = 32.768kHz, Fig. 5			-1.35	V
Current Dissipation	IDD	VSS2 = -2.9V, crystal OSC, HALT mode, C1 = C2 = 0.1μF, Co = Cg = 20pF, CI ≤ 25kΩ, Fig. 5		5.0		μA
Oscillation Start Voltage	Vstt	Co = Cg = 20pF, crystal OSC (CI ≤ 25kΩ), Fig. 6	-2.2			V
Oscillation Hold Voltage	VHOLD	Co = Cg = 20pF, crystal OSC (CI ≤ 25kΩ), Fig. 6			-2.0	V
Oscillation Start Time	tstt	VSS2 = -2.2V, Co = Cg = 20pF, crystal OSC (CI ≤ 25kΩ), Fig. 6			10	s
Oscillation Compensation Capacitance	10P	External pin	8	10	12	pF

*1 S1, S2, S3, S4; M1, M2, M3, M4

*2 LCD driver output pins out of SEGOUT1 to 13 and SEGOUT14 to 27

*3 Output pins out of SEGOUT14 to 27

LC5732, 5732H

Specifications for LC5732

● EXT-V Version 1 [Crystal OSC]

Absolute Maximum Ratings at Ta = 25 ± 2°C, VDD = 0V

			unit
Maximum Supply Voltage	VSS1	-7.0 to +0.3	V
	VSS2	-7.0 to +0.3	V
Maximum Input Voltage	VIN	10P, OSCIN, 32Hz, S1-4, M1-4, TEST, RES	VSS2 - 0.3 to 0.3 V
Maximum Output Voltage	VOU	32Hz, CUP2, OSCOUT, SEGOUT, COM1, COM2, COM3, CUP1, LIGHT, ALM1, ALM2	VSS2 - 0.3 to 0.3 V
Operating Temperature	Topr		-30 to +70 °C
Storage Temperature	Tstg		-40 to +125 °C

Allowable Operating Conditions at Ta = -30 to +70°C, VDD = 0V

			min	typ	max	unit
Supply Voltage	VSS1		-6.0	-1.3		V
	VSS2		-6.0	-2.0		V
Input 'H'-Level Voltage	VIH1	S1-4, M1-4, RES	0.3 × VSS2		0	V
Input 'L'-Level Voltage	VIL1	S1-4, M1-4, RES		VSS2	0.7 × VSS2	V
Input 'H'-Level Voltage	VIH2	RES	0.25 × VSS2		0	V
Input 'L'-Level Voltage	VIL2	RES		VSS2	0.75 × VSS2	V
Operating Frequency	fopg	Crystal OSC (recommended OSC circuit Fig.7)	32		33	kHz

Electrical Characteristics at Ta = -30 to +70°C, VDD = 0V

			min	typ	max	unit
Input Resistance	RIN1A	VSS2 = -5.0V, VIL = VSS2 + 0.4V, 'L' level hold tr., ※1, Fig.4	100		1000	kΩ
	RIN1B	VSS2 = -5.0V, 'L' level pull-in tr., ※1, Fig.4	100		1000	kΩ
	RIN2	VSS2 = -5.0V, TEST, RES	10		300	kΩ
Output 'H'-Level Voltage	VOH1	VSS2 = -5.0V, IOH = -0.4μA, ※2	-0.2			V
Output 'L'-Level Voltage	VOL1	VSS2 = -5.0V, IOL = 0.4μA, ※2		VSS2 + 0.2		V
Output 'H'-Level Voltage	VOH2	VSS2 = -5.0V, IOH = -4μA, COM1, COM2, COM3	-0.2			V
Output 'M'-Level Voltage	VOM	VSS2 = -5.0V, IOH = -4μA, IOL = 4μA, COM1, COM2, COM3	VSS2/2 - 0.2	VSS2/2 + 0.2		V
Output 'L'-Level Voltage	VOL2	VSS2 = -5.0V, IOL = 4μA, COM1, COM2, COM3		VSS2 + 0.2		V
Output 'H'-Level Voltage	VOH3	VSS2 = -5.0V, IOH = -2.0mA, ALM1, ALM2	-1.0			V
Output 'L'-Level Voltage	VOL3	VSS2 = -5.0V, IOL = 2.0mA, ALM1, ALM2		VSS2 + 1.0		V
Output 'H'-Level Voltage	VOH4	VSS2 = -5.0V, IOH = -250μA, LIGHT	-1.5			V
Output 'L'-Level Voltage	VOL4	VSS2 = -5.0V, IOL = 250μA, LIGHT		VSS2 + 1.5		V
Output 'H'-Level Voltage	VOH5	VSS2 = -5.0V, IOH = -80μA, ※3	-0.8			V
Output 'L'-Level Voltage	VOL5	VSS2 = -5.0V, IOL = 80μA, ※3		VSS2 + 0.8		V
Output Voltage (halver)	VSS1	VSS2 = -5.0V, C1 = C2 = 0.1μF, fopg = 32.768kHz, Fig.5			-2.4	V
Current Dissipation	IDD	VSS2 = -5.0V, crystal OSC, HALT mode, C1 = C2 = 0.1μF, Co = Cg = 20pF, CI ≤ 25kΩ, Fig.5		10.0		μA
Oscillation Start Voltage	Vstt	Co = Cg = 20pF, crystal OSC (CI ≤ 25kΩ), Fig.6	-2.3			V
Oscillation Hold Voltage	VHOLD	Co = Cg = 20pF, crystal OSC (CI ≤ 25kΩ), Fig.6			-2.0	V
Oscillation Start Time	tstt	VSS2 = -2.3V, Co = Cg = 20pF, crystal OSC (CI ≤ 25kΩ), Fig.6			10	s
Oscillation Compensation Capacitance	10P	External pin	8	10	12	pF

※1 S1, S2, S3, S4 ; M1, M2, M3, M4

※2 LCD driver output pins out of SEGOUT1 to 13 and SEGOUT14 to 27

※3 Output pins out of SEGOUT14 to 27

LC5732, 5732H

● EXT-V Version 2 [Ceramic resonator OSC] ※0

Absolute Maximum Ratings at Ta = 25 ± 2°C, VDD = 0V

			unit
Maximum Supply Voltage	VSS1	-7.0 to +0.3	V
	VSS2	-7.0 to +0.3	V
Maximum Input Voltage	VIN	10P, OSCIN, 32Hz, S1-4, M1-4, TEST, RES	VSS2 - 0.3 to 0.3 V
Maximum Output Voltage	VOU	32Hz, CUP2, OSCOUT, SEGOUT, COM1, COM2, COM3, CUP1, LIGHT, ALM1, ALM2	VSS2 - 0.3 to 0.3 V
Operating Temperature	Topr		-30 to +70 °C
Storage Temperature	Tstg		-40 to +125 °C

Allowable Operating Conditions at Ta = -30 to +70°C, VDD = 0V

			min	typ	max	unit
Supply Voltage	VSS1		-6.0		-2.0	V
	VSS2		-6.0		-4.0	V
Input 'H'-Level Voltage	VIH1	S1-4, M1-4	0.3 × VSS2		0	V
Input 'L'-Level Voltage	VIL1	S1-4, M1-4		VSS2	0.7 × VSS2	V
Input 'H'-Level Voltage	VIH2	RES	0.25 × VSS2		0	V
Input 'L'-Level Voltage	VIL2	RES		VSS2	0.75 × VSS2	V
Operating Frequency	fopg	Using recommended ceramic resonator ※0 (Recommended OSC circuit Fig.12)	380	400	420	kHz

Electrical Characteristics at Ta = -30 to +70°C, VDD = 0V

			min	typ	max	unit
Input Resistance	RIN1A	VSS2 = -5.0V, VIL = VSS2 + 0.4V, 'L' level hold tr., ※1, Fig.4	100		1000	kΩ
	RIN1B	VSS2 = -5.0V, 'L' level pull-in tr., ※1, Fig.4	100		1000	kΩ
	RIN2	VSS2 = -5.0V, TEST, RES	10		300	kΩ
Output 'H'-Level Voltage	VOH1	VSS2 = -5.0V, IOH = -0.4μA, ※2	-0.2			V
Output 'L'-Level Voltage	VOL1	VSS2 = -5.0V, IOL = 0.4μA, ※2		VSS2 + 0.2		V
Output 'H'-Level Voltage	VOH2	VSS2 = -5.0V, IOH = -4μA, COM1, COM2, COM3	-0.2			V
Output 'M'-Level Voltage	VOM	VSS2 = -5.0V, IOH = -4μA, IOL = 4μA, COM1, COM2, COM3	VSS2/2 - 0.2	VSS2/2 + 0.2		V
Output 'L'-Level Voltage	VOL2	VSS2 = -5.0V, IOL = 4μA, COM1, COM2, COM3		VSS2 + 0.2		V
Output 'H'-Level Voltage	VOH3	VSS2 = -5.0V, IOH = -2.0mA, ALM1, ALM2	-1.0			V
Output 'L'-Level Voltage	VOL3	VSS2 = -5.0V, IOL = 2.0mA, ALM1, ALM2		VSS2 + 1.0		V
Output 'H'-Level Voltage	VOH4	VSS2 = -5.0V, IOH = -250μA, LIGHT	-1.50			V
Output 'L'-Level Voltage	VOL4	VSS2 = -5.0V, IOL = 250μA, LIGHT		VSS2 + 1.50		V
Output 'H'-Level Voltage	VOH5	VSS2 = -5.0V, IOH = -80μA, ※3	-0.8			V
Output 'L'-Level Voltage	VOL5	VSS2 = -5.0V, IOL = 80μA, ※3		VSS2 + 0.8		V
Output Voltage (halver)	VSS1	VSS2 = -5.0V, C1 = C2 = 0.1μF, fopg = 400kHz, Fig.9			-2.4	V
Current Dissipation	IDD	VSS2 = -5.0V, ceramic resonator OSC, HALT mode, C1 = C2 = 0.1μF, Co = Cg = 100pF, Fig.9		50		μA
Oscillation Start Voltage	Vstt	Co = Cg = 100pF, ceramic resonator OSC, Fig.10	-3.0			V
Oscillation Hold Voltage	VHOLD	Co = Cg = 100pF, ceramic resonator OSC, Fig.10			-3.0	V
Oscillation Start Time	tstt	VSS2 = -3.0V, Co = Cg = 100pF, ceramic resonator OSC, Fig.10			10	s
External Capacitance for Ceramic Resonator OSC	Co	Fig.12		100 ± 10%		pF
	Cg	Fig.12		100 ± 10%		pF
External Resistance for Ceramic Resonator OSC	R	Fig.12		1000 ± 5%		kΩ

※0 Recommended ceramic resonator : CSB400P (Murata), KBR400B (Kyocera)

※1 S1, S2, S3, S4 ; M1, M2, M3, M4

※2 LCD driver output pins out of SEGOUT1 to 13 and SEGOUT14 to 27

※3 Output pins out of SEGOUT14 to 27

LC5732, 5732H

●EXT-V Version 3 [CR OSC]

Absolute Maximum Ratings at Ta = 25 ± 2°C, VDD = 0V

			unit
Maximum Supply Voltage	VSS1	-7.0 to +0.3	V
	VSS2	-7.0 to +0.3	V
Maximum Input Voltage	VIN	10P, OSCIN, 32Hz, S1-4, M1-4, TEST, RES	VSS2 - 0.3 to 0.3 V
Maximum Output Voltage	VOOUT	32Hz, CUP2, OSCOUT, SEGOUT, COM1, COM2, COM3, CUP1, LIGHT, ALM1, ALM2	VSS2 - 0.3 to 0.3 V
Operating Temperature	Topr		-30 to +70 °C
Storage Temperature	Tstg		-40 to +125 °C

Allowable Operating Conditions at Ta = -30 to +70°C, VDD = 0V

			min	typ	max	unit
Supply Voltage	VSS1		-6.0		-1.3	V
	VSS2		-6.0		-2.5	V
Input 'H'-Level Voltage	VIH1	S1-4, M1-4	0.3 × VSS2		0	V
Input 'L'-Level Voltage	VIL1	S1-4, M1-4		VSS2	0.7 × VSS2	V
Input 'H'-Level Voltage	VIH2	RES	0.25 × VSS2		0	V
Input 'L'-Level Voltage	VIL2	RES		VSS2	0.75 × VSS2	V
Operating Frequency	fopg	Using recommended CR OSC circuit (Fig.11)	100	250	400	kHz

Electrical Characteristics at Ta = -30 to +70°C, VDD = 0V

			min	typ	max	unit
Input Resistance	RIN1A	VSS2 = -5.0V, VIL = VSS2 + 0.4V, 'L' level hold tr., *1, Fig.4	100		1000	kΩ
	RIN1B	VSS2 = -5.0V, 'L' level pull-in tr., *1, Fig.4	100		1000	kΩ
	RIN2	VSS2 = -5.0V, TEST, RES	10		300	kΩ
Output 'H'-Level Voltage	VOH1	VSS2 = -5.0V, IOH = -0.4μA, *2	-0.2			V
Output 'L'-Level Voltage	VOL1	VSS2 = -5.0V, IOL = 0.4μA, *2		VSS2 + 0.2		V
Output 'H'-Level Voltage	VOH2	VSS2 = -5.0V, IOH = -4μA, COM1, COM2, COM3	-0.2			V
Output 'M'-Level Voltage	VOM	VSS2 = -5.0V, IOH = -4μA, IOL = 4μA, COM1, COM2, COM3	VSS2/2 - 0.2		VSS2/2 + 0.2	V
Output 'L'-Level Voltage	VOL2	VSS2 = -5.0V, IOL = 4μA, COM1, COM2, COM3		VSS2 + 0.2		V
Output 'H'-Level Voltage	VOH3	VSS2 = -5.0V, IOH = -2.0mA, ALM1, ALM2	-1.0			V
Output 'L'-Level Voltage	VOL3	VSS2 = -5.0V, IOL = 2.0mA, ALM1, ALM2		VSS2 + 1.0		V
Output 'H'-Level Voltage	VOH4	VSS2 = -5.0V, IOH = -250μA, LIGHT	-1.50			V
Output 'L'-Level Voltage	VOL4	VSS2 = -5.0V, IOL = 250μA, LIGHT		VSS2 + 1.50		V
Output 'H'-Level Voltage	VOH5	VSS2 = -5.0V, IOH = -80μA, *3	-0.8			V
Output 'L'-Level Voltage	VOL5	VSS2 = -5.0V, IOL = 80μA, *3		VSS2 + 0.8		V
Output Voltage (halver)	VSS1	VSS2 = -5.0V, Rext = 91kΩ, Cext = 30pF, C1 = C2 = 0.1μF, Fig.8			-2.4	V
Current Dissipation	IDD	VSS2 = -5.0V, Rext = 91kΩ, Cext = 30pF, Fig.8		250		μA
External Capacitance for CR OSC	Cext	Fig.11	10	30	100	pF
External Resistance for CR OSC	Rext	Fig.11	30	91	200	kΩ

*1 S1, S2, S3, S4 ; M1, M2, M3, M4

*2 LCD driver output pins out of SEGOUT1 to 13 and SEGOUT14 to 27

*3 Output pins out of SEGOUT14 to 27

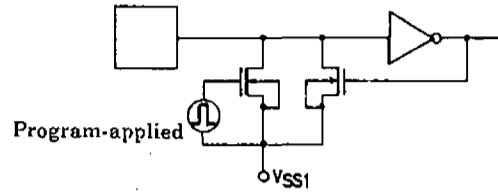

Fig. 1 Input configuration of S1-4, M1-4

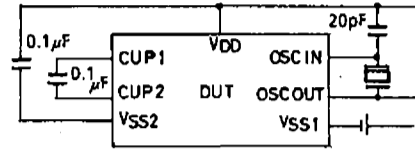

Fig. 2 Current dissipation, output voltage test circuit

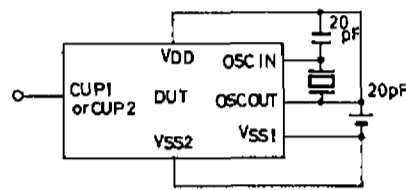

Fig. 3 Oscillation start voltage, oscillation start time, frequency stability, oscillation hold voltage test circuit

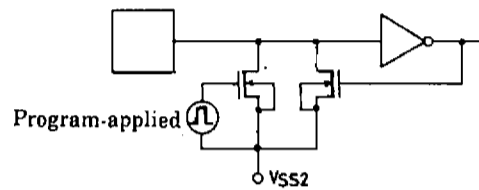

Fig. 4 Input configuration of S1-4, M1-4

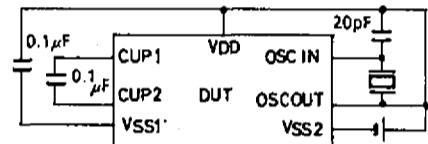

Fig. 5 Current dissipation, output voltage test circuit

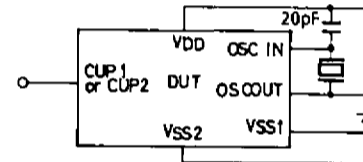

Fig. 6 Oscillation start voltage, oscillation start time, frequency stability, oscillation hold voltage test circuit

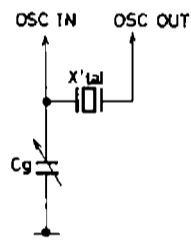

Fig. 7 Recommended crystal oscillation circuit

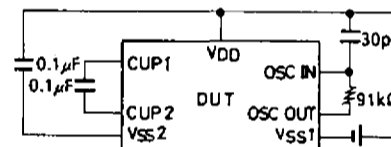

Fig. 8 Current dissipation, output voltage test circuit

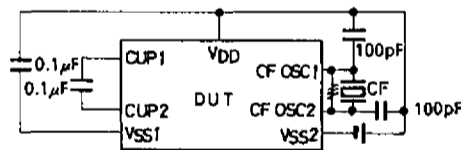

Fig. 9 Current dissipation, output voltage test circuit

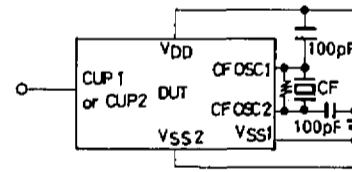

Fig. 10 Oscillation start voltage, oscillation start time, frequency stability, oscillation hold voltage test circuit

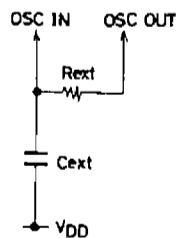

Fig. 11 Recommended CR oscillation circuit

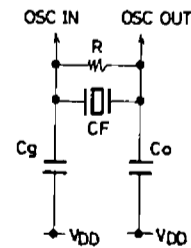

Fig. 12 Recommended ceramic resonator oscillation circuit