

Ordering number: EN 3969B

Monolithic Linear IC

SANYO	No.3969B	LA7454W
		FM Audio Recording/Playback Processor for 8-mm VCRs

Overview

The LA7454W is an audio recording and playback processor for 8-mm VCRs that is compatible with both PAL and NTSC video standards, and which supports stereo, standard-play (SP) and long-play (LP) modes.

The LA7454W incorporates an FM modulator and demodulator, a bandpass filter and deviation limiter for processing the encoded signal. On-chip noise reduction, long-play emphasis and lowpass filter circuits process and recover the audio signals.

The LA7454W operates from a single 4.75 V supply and is available in 48-pin QFPs.

Features

- Support for PAL and NTSC
- Stereo operation
- Supports SP and LP modes
- LP emphasis
- Noise reduction circuit
- Audio level control
- Audio fader
- 30 kHz lowpass filter
- 1.5 MHz bandpass filter
- Line amplifier for earphones
- Power mute for external amplifiers
- Low external component count
- Low power consumption
- 4.75 V supply
- 48-pin QFP

SANYO Electric Co., Ltd. Semiconductor Business Headquarters
TOKYO OFFICE Tokyo Bldg., 1-10, 1 Chome, Ueno, Taito-ku, TOKYO, 110 JAPAN

31596TH/9051TS No.3969-1/20

LA7454W

Block Diagram

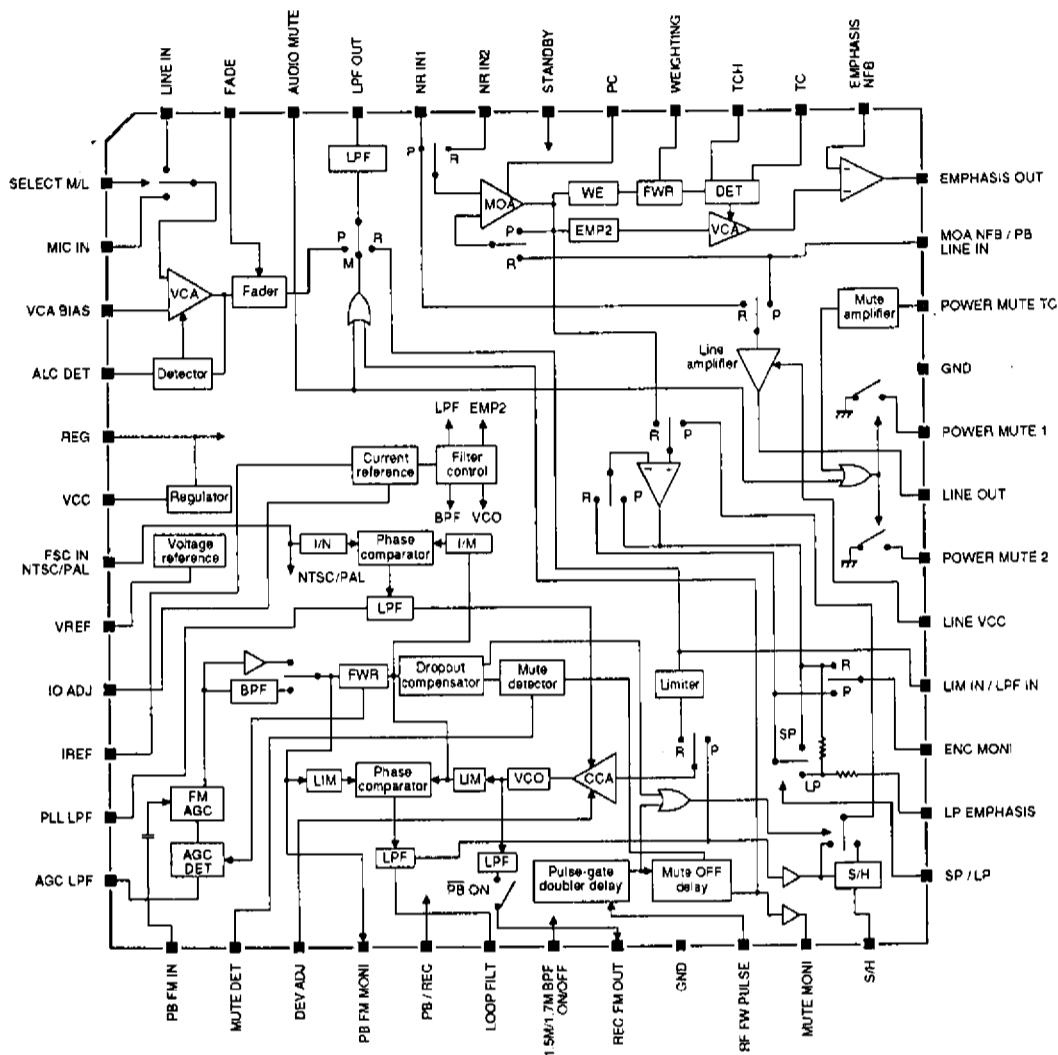

Pin Functions

Number	Name	Equivalent circuit	Function
1	PB FM IN		Playback FM signal input. Nominal AC input voltage is 30 mV _{p-p} .
2	MUTE DET		Mute detect output

LA7454W

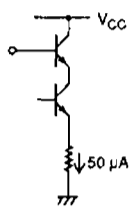
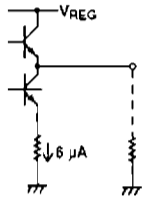
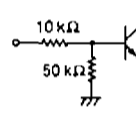
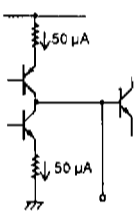
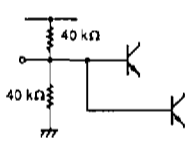
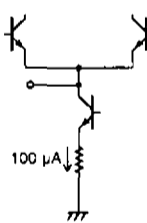
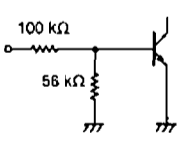
Number	Name	Equivalent circuit	Function
3	- DEV ADJ		VCO deviation adjust input
4	PB FM MONI		Playback FM signal monitor output. Nominal DC bias voltage is 2.1 V. Nominal AC output voltage is 280 mV _{p-p} .
5	PB/REC		Playback/recording select input.
6	LOOP FILT		PLL loop filter input. Nominal DC bias voltage is 2.1 V. Nominal AC level is -15 dBs.
7	1.5 M/1.7 M BPF ON/OFF		PLL center frequency and bandpass filter mode selection
8	REC FM OUT		Recording FM signal output. Nominal DC bias voltage is 2.1 V. Nominal AC output voltage is 340 mV _{p-p} . In playback mode, the nominal DC bias voltage is 1.4 V and the nominal AC output voltage is 0 V.
9	GND		Ground
10	RF SW PULSE		RF switch pulse input

LA7454W

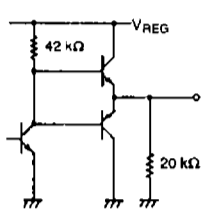
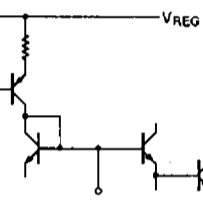
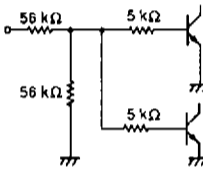
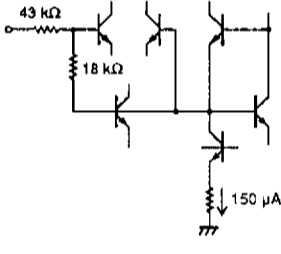
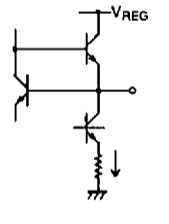
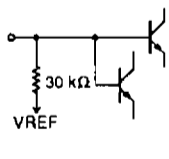
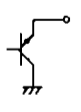
Number	Name	Equivalent circuit	Function
11	MUTE MONI		MUTE monitor output
12	S/H		Sample-and-hold input. Nominal DC input voltage is 2.1 V. Nominal AC input level is -15 dBs.
13	SP/LP		Standard-play/long-play select input
14	LP EMPHASIS		Long-play emphasis capacitor connection. Nominal DC input voltage is 2.1 V. Nominal AC input level is -15 dBs.
15	ENC MONI		Recording/playback encoding monitor output. Nominal DC bias voltage is 2.1 V. Nominal AC output level is -15 dBs.
16	LIM IN/LPF IN		Limiter and lowpass filter input. Nominal DC input voltage is 2.1 V. Nominal AC input level is -15 dBs.
17	LINE VCC		Line amplifier supply
18	POWER MUTE 2		Mute output 2

LA7454W

Number	Name	Equivalent circuit	Function
19	LINE OUT		Line amplifier output. Nominal DC bias voltage is 2.1 V. Nominal AC output level is -7 dBs.
20	POWER MUTE 1		Mute output 1
21	GND		Ground
22	POWER MUTE TC		Mute time adjust input
23	MOA NFB/PB LINE IN		Input to LINE amplifier and MOA negative feedback input. Nominal DC input voltage is 2.1 V. Nominal AC input level is -15 dBs.
24	EMPHASIS OUT		Emphasis feedback network connection. Nominal DC bias voltage is 2.1 V. Nominal AC output level is -15 dBs.
25	EMPHASIS NFB		Negative feedback input of emphasis amplifier. Nominal DC input voltage is 2.1 V. Nominal AC input level is -27.6 dBs.
26	TC		Time constant capacitor connection. Nominal DC bias voltage is 2.0 V.

LA7454W

Number	Name	Equivalent circuit	Function
27	TCH		Time constant hold capacitor connection. Nominal DC bias voltage is 2.6 V.
28	WEIGHTING		Weighting capacitor connection. Nominal DC bias voltage is 2.1 V.
29	PC		Phase compensation capacitor connection. Nominal DC bias voltage is 2.8 V.
30	STANDBY		Standby mode input
31	NR IN2		Noise reduction network connection 2. Nominal DC input voltage is 2.1 V. Nominal AC input level is -15 dBs.
32	NR IN1		Noise reduction network connection 1. Nominal DC input voltage is 2.1 V. Nominal AC input level is -15 dBs.
33	LPF OUT		Lowpass filter output. Nominal DC bias voltage is 2.1 V. Nominal AC output level is -15 dBs.

LA7454W

Number	Name	Equivalent circuit	Function
34	AUDIO MUTE		Audio mute input
35	FADE		FADE control input
36	LINE IN		LINE signal input. Nominal AC input level is -21.0 dBs.
37	SELECT M/L		Source select input
38	MIC IN		MIC signal input. Nominal AC input level is -38.0 dBs.
39	VCA BIAS		VCA bias input. Nominal DC input voltage is 2.1 V.
40	ALC DET		Audio level control input

LA7454W

Number	Name	Equivalent circuit	Function
41	REG		Internal voltage regulator output. Nominal DC bias voltage is 4.2 V.
42	VCC		4.75 V supply
43	FSC IN NTSC/PAL		NTSC/PAL mode select and FSC input
44	VREF		Voltage reference output. Nominal DC bias voltage is 2.1 V.
45	IO ADJ		Current reference adjust input
46	IREF		Current reference output. Nominal DC bias voltage is 2.2 V with 3.3 V applied to IO ADJ.
47	PLL LPF		PLL loop filter input. Nominal DC input voltage is 2.1 V.

LA7454W

Number	Name	Equivalent circuit	Function
48	AGC LPF		AGC response adjust input. Nominal DC input voltage is 2.1 V.

Specifications

Absolute Maximum Ratings

Parameter	Symbol	Ratings	Unit
Supply voltage	V_{CC}	7	V
Power dissipation	P_D	300	mW
Operating temperature range	T_{opr}	-20 to +75	°C
Storage temperature range	T_{stg}	-40 to +150	°C

Recommended Operating Conditions

$T_a = 25\text{ }^\circ\text{C}$

Parameter	Symbol	Ratings	Unit
Supply voltage	V_{CC}	4.75	V
Supply voltage range	V_{CC}	4.5 to 5.5	V

Electrical Characteristics

$V_{CC} = 4.75\text{ V}$, $T_a = 25\text{ }^\circ\text{C}$

No.	Parameter	Symbol	Conditions	Ratings			Unit
				min	typ	max	
1	Standby-mode supply current	I_{CCST}		19.2	24.0	28.8	mA
2	Recording-mode supply current	I_{CCR}		21.6	27.0	32.4	mA
3	Playback-mode supply current	I_{CCP}	Bandpass filter is ON.	24.8	31.0	37.2	mA
4			Bandpass filter is OFF.	21.6	27.0	32.4	
5	REG output voltage	V_{REG}		4.05	4.20	4.35	V
6	Reference voltage	V_{REF}		2.02	2.10	2.18	V

LA7454W

Recording-mode characteristics

Audio level control and lowpass filter circuits

No.	Parameter	Symbol	Conditions	Ratings			Unit
				min	typ	max	
7	Input switch crosstalk	CT	f = 10 kHz, mode 1, -5 dBs input level	-	-78	-70	dB
8			f = 10 kHz, mode 2, -5 dBs input level	-	-78	-70	
9	ALC output level	V _{oa}	f = 400 Hz, -38 dBs MIC input level	-16	-15	-14	dBs
10			f = 400 Hz, -25 dBs MIC input level	-10.5	-9.0	-7.5	
11			f = 400 Hz, -21 dBs LINE input level	-16	-15	-14	
12	ALC response	ALC	f = 400 Hz, -28 dBs to -2 dBs input level change	-	0	3	dB
13	FADE attenuation	α _{FADE}	f = 400 Hz, -38 dBs input level, V _{IN4} = 4.5 V	80	85	-	dBs

Noise reduction circuit

No.	Parameter	Symbol	Conditions	Ratings			Unit
				min	typ	max	
14	Output level	V _{oe}	f = 400 Hz, -15 dBs input level	-16	-15	-14	dBs
15			f = 400 Hz, -35 dBs input level	-26.5	-25.0	-23.5	
16			f = 400 Hz, -55 dBs input level	-37	-35	-33	
17			f = 7 kHz, -15 dBs input level	-12.4	-10.9	-9.4	
18			f = 7 kHz, -35 dBs input level	-22.4	-20.9	-19.4	
19			f = 7 kHz, -55 dBs input level	-32.9	-30.9	-28.9	
20	Total harmonic distortion	THD _E	f = 400 Hz, -15 dBs input level	-	0.2	0.5	%
21	Output noise level	V _{noe}	R _o = 1 kΩ, IHF-A filter	-	-57	-51	dBs

LA7454W

Line amplifier

No.	Parameter	Symbol	Conditions	Ratings			Unit
				min	typ	max	
22	Line output level	V_o	$f = 400$ Hz, -38 dBs input level	-8.5	-7.0	-5.5	dBs
23	Line output noise level	V_{no}	$R_g = 1$ k Ω , IHF-A filter, LINE input	-	-79	-74	dBs
24			$R_g = 1$ k Ω , IHF-A filter, MIC input	-	-76	-71	
25	Line output distortion	THD _L	$f = 400$ Hz, -38 dBs input level	-	0.1	0.4	%
26	Earphone output level	V_{oep}	$f = 400$ Hz, -38 dBs input level	-27.5	-26.0	-24.5	dBs
27	Maximum line output level	V_o max	$f = 400$ Hz, THD = 1%	0.5	2.5	-	dBs

FM modulator

No.	Parameter	Symbol	Conditions	Ratings			Unit
				min	typ	max	
28	Oscillator frequency	f_o	NTSC mode, 1.5 MHz selected, $f = 3.579545$ MHz	1.4995	1.5000	1.5005	MHz
29			NTSC mode, 1.7 MHz selected, $f = 3.579545$ MHz	1.6995	1.7000	1.7005	
30			PAL mode, 1.5 MHz selected, $f = 4.433619$ MHz	1.4995	1.5000	1.5005	
31			PAL mode, 1.7 MHz selected, $f = 4.433619$ MHz	1.6995	1.7000	1.7005	
32	Output voltage	V_{or}	$f = 3.579545$ MHz	300	340	380	mV _{p-p}
33	Second-harmonic distortion	HD _{2nd}	$f = 3.579545$ MHz	-	-46	-40	dB
34	Third-harmonic distortion	HD _{3rd}	$f = 3.579545$ MHz	-	-31	-25	dB

Playback-mode characteristics

FM demodulator

No.	Parameter	Symbol	Conditions	Ratings			Unit
				min	typ	max	
35	Output level	V_{dem}	$f_c = 1.5$ MHz, 30 mV _{p-p} , 60 kHz FM deviation, $f_m = 1$ kHz	-16.0	-15.0	-14.0	dBs
36	Output distortion	THD _d	$f_c = 1.5$ MHz, 30 mV _{p-p} , 60 kHz FM deviation, $f_m = 1$ kHz	-	0.26	0.4	%

LA7454W

No.	Parameter	Symbol	Conditions	Ratings			Unit
				min	typ	max	
37	Output noise level	V_{nod}	$f_c = 1.5 \text{ MHz}$, 30 mV _{p-p} , IHF-A filter	-	-71	-64	dBs
38	AM rejection	AM_{rej}	$f_c = 1.5 \text{ MHz}$, 30 mV _{p-p} , 30% modulation, $f_m = 1 \text{ kHz}$	-	-71	-64	dBs

Lowpass filter

No.	Parameter	Symbol	Conditions	Ratings			Unit
				min	typ	max	
39	Lowpass filter output level	V_{OLPF}	$f_c = 1.5 \text{ MHz}$, 30 mV _{p-p} , 60 kHz FM deviation, $f_m = 10 \text{ kHz}$	-16.0	-15.0	-14.0	dBs
40			$f_c = 1.5 \text{ MHz}$, 30 mV _{p-p} , 60 kHz FM deviation, $f_m = 30 \text{ kHz}$	-17.5	-16.5	-15.5	
41			$f_c = 1.5 \text{ MHz}$, 30 mV _{p-p} , 60 kHz FM deviation, $f_m = 7 \text{ kHz}$, long play emphasis is ON.	-19.5	-17.5	-15.5	

FM automatic gain control circuit

No.	Parameter	Symbol	Conditions	Ratings			Unit
				min	typ	max	
42	AGC output voltage	V_{OAGC}	$f_c = 1.5 \text{ MHz}$, 30 mV _{p-p}	220	280	340	mV _{p-p}
43			$f_c = 1.5 \text{ MHz}$, 7 mV _{p-p}	130	170	210	
44			$f_c = 1.5 \text{ MHz}$, 12 mV _{p-p}	220	280	340	
45			$f_c = 1.5 \text{ MHz}$, 100 mV _{p-p}	220	280	340	

Bandpass filter

No.	Parameter	Symbol	Conditions	Ratings			Unit
				min	typ	max	
46	Bandpass filter response	BPF_r	$f_c = 1.5 \text{ MHz} \pm 100 \text{ kHz}$, 7 mV _{p-p}	-6	-5	-3	dB
47			$f_c = 1.5 \text{ MHz} \pm 200 \text{ kHz}$, 7 mV _{p-p}	-	-15.5	-14.5	
48			$f_c = 1.2 \text{ MHz}$, 7 mV _{p-p}	-	-38	-31	
49			$f_c = 1.8 \text{ MHz}$, 7 mV _{p-p}	-	-35	-30	
50	Voltage gain	VG_{BPF}	Bandpass filter is OFF.	26	28	30	dB

LA7454W

Dropout mute circuit

No.	Parameter	Symbol	Conditions	Ratings			Unit
				min	typ	max	
51	Dropout detection threshold	DO _{ON}		-10.0	-7.5	-5.0	dB
52	Dropout hysteresis	DO _{OFF}		1.0	3.5	6.0	dB
53	Mute ON time	t _{MDN}	See measurement waveforms.	140	220	300	μs
54	Mute hold time	t _{MH}	See measurement waveforms.	130	150	170	ms
55	Pulse-gate doubler pulsewidth	t _{PGW}	f _c = 1.5 MHz, 30 mV _{p-p} , 1.5 MHz BPF is ON.	5.0	7.0	9.0	μs
56			f _c = 1.5 MHz, 30 mV _{p-p} , 1.5 MHz BPF is OFF.	5.5	7.5	9.5	
57			f _c = 1.5 MHz, 30 mV _{p-p} , 1.7 MHz selected	6.7	8.7	10.7	
58	Pulse-gate doubler delay time	t _{PST}	f _c = 1.5 MHz, 30 mV _{p-p} , 1.5 MHz BPF is ON.	1.0	2.0	3.0	μs
59			f _c = 1.5 MHz, 30 mV _{p-p} , 1.5 MHz BPF is OFF.	1.0	2.0	3.0	
60			f _c = 1.5 MHz, 30 mV _{p-p} , 1.7 MHz selected	1.0	2.0	3.0	

External adjustment

No.	Parameter	Symbol	Conditions	Ratings			Unit
				min	typ	max	
61	Reference current adjustment range	I _O	V _{TP11} = 2.2 V	1.85	3.3	V _{REG}	V
62	VCO deviation adjustment range	DEV	f = 400 Hz, -15 dBs signal level, signal on TP2 is 1.5 MHz ±60 kHz.	1.85	3.3	V _{REG}	V
63	FADE adjustment range	FADE	f = 400 Hz, -38 dBs signal level, signal on TP8 is -80 dBs.	1.85	3.3	V _{REG}	V

Power mute circuit

No.	Parameter	Symbol	Conditions	Ratings			Unit
				min	typ	max	
64	Power mute 1 ON-resistance	R _{PM1}		-	20	30	Ω
65	Power mute 2 ON-resistance	R _{PM2}		-	20	30	Ω

LA7454W

Test Conditions

No.	Switch position															Input point	Measurement point
	SW1	SW2	SW3	SW4	SW5	SW6	SW7	SW8	SW9	SW10	SW11	SW12	SW13	SW14	SW15		
1	b	a	b	a	b	OFF	b	a	b	b	b	b	a	b	a		
2	b	a	b	a	b	OFF	a	a	b	b	b	b	a	b	a		
3	a	a	b	a	b	OFF	a	a	b	b	b	b	a	b	a		
4	a	b	b	a	b	OFF	a	a	b	b	b	b	a	b	a		
5	b	a	b	a	b	OFF	a	a	b	b	b	b	a	b	a		TP9
6	b	a	b	a	b	OFF	a	a	b	b	b	b	a	b	a		TP10
7	b	a	b	a	b	OFF	a	c	b	b	b	a	a	b	a	IN5	TP8
8	b	a	b	a	b	OFF	a	c	b	b	b	b	b	a	a	IN5	TP8
9	b	a	b	a	b	OFF	a	c	b	b	b	b	a	a	a	IN5	TP8
10	b	a	b	a	b	OFF	a	c	b	b	b	a	b	b	a	IN5	TP8
11	b	a	b	a	b	OFF	a	c	b	b	b	b	a	a	a	IN5	TP8
12	b	a	b	a	b	OFF	a	c	b	b	b	b	a	a	a	IN5	TP8
13	b	a	b	a	b	OFF	a	c	b	a	b	b	a	a	a	IN5	TP8
14	b	a	b	a	b	OFF	a	c	b	b	a	b	a	a	a	IN5	TP4
15	b	a	b	a	b	OFF	a	c	b	b	a	b	a	a	a	IN5	TP4
16	b	a	b	a	b	OFF	a	c	b	b	a	b	a	a	a	IN5	TP4
17	b	a	b	a	b	OFF	a	c	b	b	a	b	a	a	a	IN5	TP4
18	b	a	b	a	b	OFF	a	c	b	b	a	b	a	a	a	IN5	TP4
19	b	a	b	a	b	OFF	a	c	b	b	a	b	a	a	a	IN5	TP4
20	b	a	b	a	b	OFF	a	c	b	b	a	b	a	a	a	IN5	TP4
21	b	a	b	a	b	OFF	a	b	b	b	b	b	a	a	a		TP4
22	b	a	b	a	b	OFF	a	a	b	b	b	b	a	a	a	IN5	TP6
23	b	a	b	a	b	OFF	a	a	b	b	b	b	b	a	a	IN5	TP6
24	b	a	b	a	b	OFF	a	a	b	b	b	b	a	b	a	IN5	TP6
25	b	a	b	a	b	OFF	a	a	b	b	b	b	a	a	a	IN5	TP6
26	b	a	b	a	b	ON	a	a	b	b	b	b	a	a	a	IN5	TP7
27	b	a	b	a	b	OFF	a	c	b	b	a	b	a	a	a	IN5	TP6
28	b	a	b	a	a	OFF	a	a	b	b	b	b	a	a	a		TP2
29	b	c	b	a	a	OFF	a	a	b	b	b	b	a	a	a		TP2
30	b	a	b	a	a	OFF	a	a	b	b	b	b	a	a	b		TP2
31	b	c	b	a	a	OFF	a	a	b	b	b	b	a	a	b		TP2
32	b	a/c	b	a	a	OFF	a	a	b	b	b	b	a	a	a		TP2
33	b	a	b	a	a	OFF	a	a	b	b	b	b	a	a	a		TP2
34	b	a	b	a	a	OFF	a	a	b	b	b	b	a	a	a		TP2
35	a	a	b	a	b	OFF	a	c	b	b	b	b	a	a	a	IN1	TP8
36	a	a	b	a	b	OFF	a	a	b	b	b	b	a	a	a	IN1	TP6

LA7454W

No.	Switch position															Input point	Measurement point
	SW1	SW2	SW3	SW4	SW5	SW6	SW7	SW8	SW9	SW10	SW11	SW12	SW13	SW14	SW15		
37	a	a	b	a	b	OFF	a	c	b	b	b	b	a	a	a		TP8
38	a	a	b	a	b	OFF	a	c	b	b	b	b	a	a	a	IN1	TP8
39	a	a	b	a	b	OFF	a	c	b	b	b	b	a	a	a	IN1	TP8
40	a	a	b	a	b	OFF	a	c	b	b	b	b	a	a	a	IN1	TP8
41	a	a	b	b	b	OFF	a	c	b	b	b	b	a	a	a	IN1	TP8
42	a	a	b	a	b	OFF	a	c	b	b	b	b	a	a	a	IN1	TP1
43	a	a	b	a	b	OFF	a	c	b	b	b	b	a	a	a	IN1	TP1
44	a	a	b	a	b	OFF	a	c	b	b	b	b	a	a	a	IN1	TP1
45	a	a	b	a	b	OFF	a	c	b	b	b	b	a	a	a	IN1	TP1
46	a	a	b	a	b	OFF	a	c	b	b	b	b	a	a	a	IN1	TP1
47	a	a	b	a	b	OFF	a	c	b	b	b	b	a	a	a	IN1	TP1
48	a	a	b	a	b	OFF	a	c	b	b	b	b	a	a	a	IN1	TP1
49	a	a	b	a	b	OFF	a	c	b	b	b	b	a	a	a	IN1	TP1
50	a	b	b	a	b	OFF	a	c	b	b	b	b	a	a	a	IN1	TP1
51	a	a	a	a	b	OFF	a	c	b	b	b	b	a	a	a	IN1	IN1
52	a	a	a	a	b	OFF	a	c	b	b	b	b	a	a	a	IN1	IN1
53	a	a	a	a	b	OFF	a	c	b	b	b	b	a	a	a	IN1	IN1
54	a	a	a	a	b	OFF	a	c	b	b	b	b	a	a	a	IN1	IN1
55	a	a	a	a	b	OFF	a	c	b	b	b	b	a	a	a	IN1	TP4
56	a	b	a	a	b	OFF	a	c	b	b	b	b	a	a	a	IN1	TP4
57	a	c	a	a	b	OFF	a	c	b	b	b	b	a	a	a	IN1	TP4
58	a	a	a	a	b	OFF	a	c	b	b	b	b	a	a	a	IN1	TP4
59	a	b	a	a	b	OFF	a	c	b	b	b	b	a	a	a	IN1	TP4
60	a	c	a	a	b	OFF	a	c	b	b	b	b	a	a	a	IN1	TP4
61	b	a	a	a	b	OFF	a	c	b	b	b	b	a	a	a		IN6
62	b	a	a	a	b	OFF	a	c	b	b	a	b	a	a	a	IN5	IN2
63	b	a	a	a	b	OFF	a	c	b	a	b	b	a	a	a	IN5	IN4
64	b	a	a	a	b	OFF	a	c	a	b	a	b	a	a	a	IN5	TP5
65	b	a	a	a	b	OFF	a	c	a	b	a	b	a	a	a	IN5	TP7

LA7454W

Test Waveforms

MUTE DET output

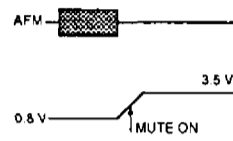

MUTE MONI output level

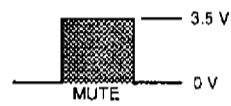

MUTE MONI timing

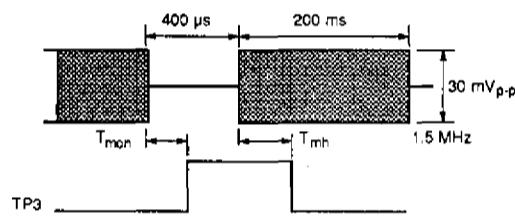

LOOP FILT Input waveform

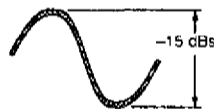

Mode Selection

Input	Mode selected if HIGH	Mode selected if floating	Mode selected if LOW
PB/REC	Playback	Recording	
SELECT M/L	MIC input	LINE input	
AUDIO MUTE	Mute ON		Mute OFF
SP/LP	Standard play	Long play	
FSC IN NTSC/PAL	NTSC	PAL	
1.5 M/1.7 M BPF ON/OFF	Bandpass filter ON, VCO frequency is 1.5 MHz.	Bandpass filter OFF, VCO frequency is 1.5 MHz.	Bandpass filter OFF, VCO frequency is 1.7 MHz.
STANDBY	Standby OFF	Standby ON	

LA7454W

Typical Application

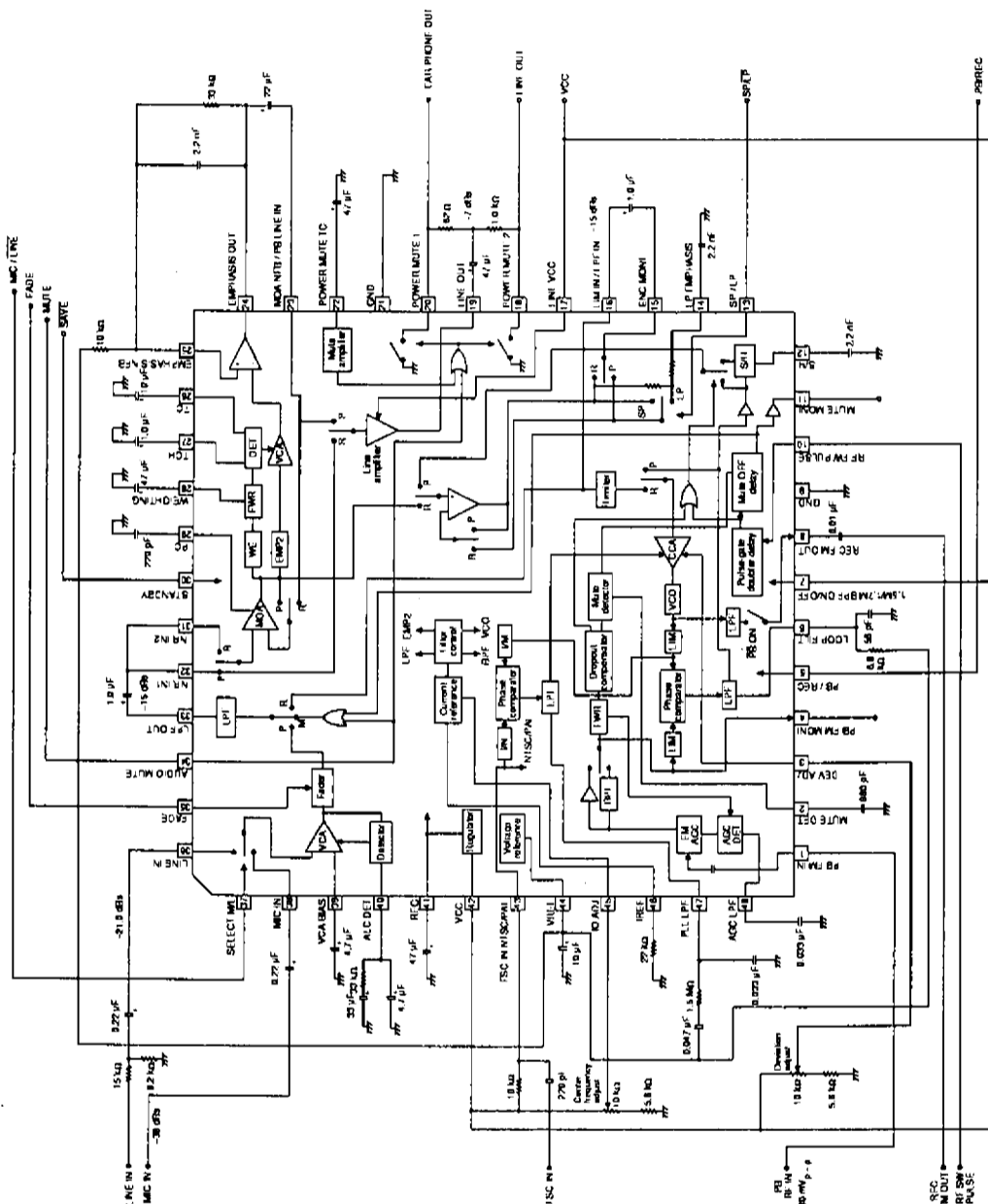

Note
Short circuit the 10 kΩ resistor on pin 43 for PAL mode.

LA7454W

- No products described or contained herein are intended for use in surgical implants, life-support systems, aerospace equipment, nuclear power control systems, vehicles, disaster/crime-prevention equipment and the like, the failure of which may directly or indirectly cause injury, death or property loss.
- Anyone purchasing any products described or contained herein for an above-mentioned use shall:
 - ① Accept full responsibility and indemnify and defend SANYO ELECTRIC CO., LTD., its affiliates, subsidiaries and distributors and all their officers and employees, jointly and severally, against any and all claims and litigation and all damages, cost and expenses associated with such use.
 - ② Not impose any responsibility for any fault or negligence which may be cited in any such claim or litigation on SANYO ELECTRIC CO., LTD., its affiliates, subsidiaries and distributors or any of their officers and employees jointly or severally.
- Information (including circuit diagrams and circuit parameters) herein is for example only; it is not guaranteed for volume production. SANYO believes information herein is accurate and reliable, but no guarantees are made or implied regarding its use or any infringements of intellectual property rights or other rights of third parties.

This catalog provides information as of **March, 1996**. Specifications and information herein are subject to change without notice.