

**SANYO**

No.3987 A

**LA1826****AM/FM Tuner with MPX Stereo Demodulator****OVERVIEW**

The LA1826 is an AM/FM tuner with MPX stereo demodulator which integrates most of the components of a complete receiver system in a monolithic linear IC, making it ideal for headphone radios and radio cassette recorders.

The LA1826 features a stereo indicator driver, can receive SW broadcasts, and operates with low carrier leakage, low power consumption and high stability.

The LA1826 can be operated from a 1.8 to 6.0 V supply and is available in a 24-pin shrink DIP.

**FEATURES**

- Stereo indicator driver
- Few external components
- Receives SW broadcasts
- High stability
- Low carrier leakage
- Low power consumption
- 1.8 to 6.0 V supply
- 24-pin shrink DIP

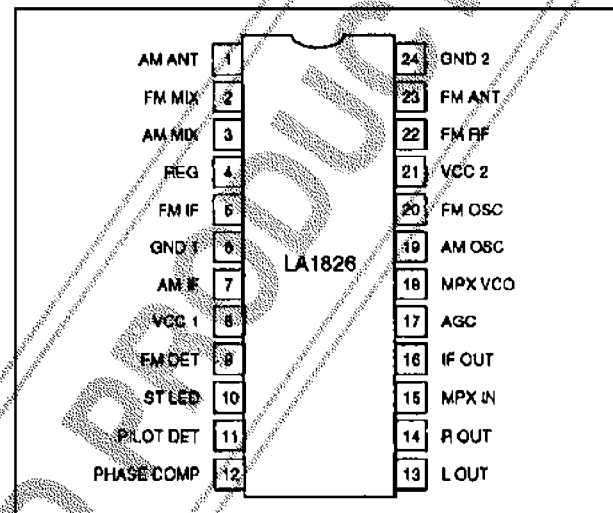
**Pin Assignment****Package Dimensions**

Unit: mm

3067-DIP24S

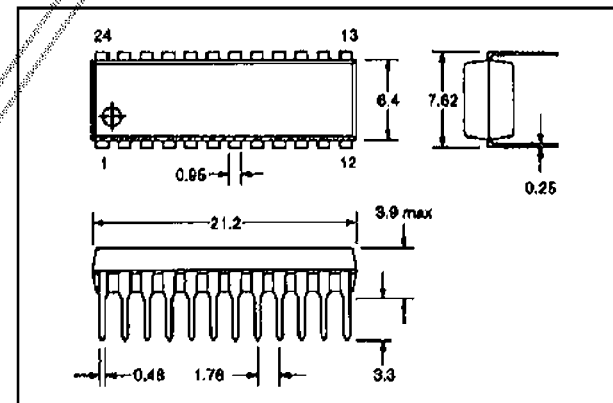

**BLOCK DIAGRAM**

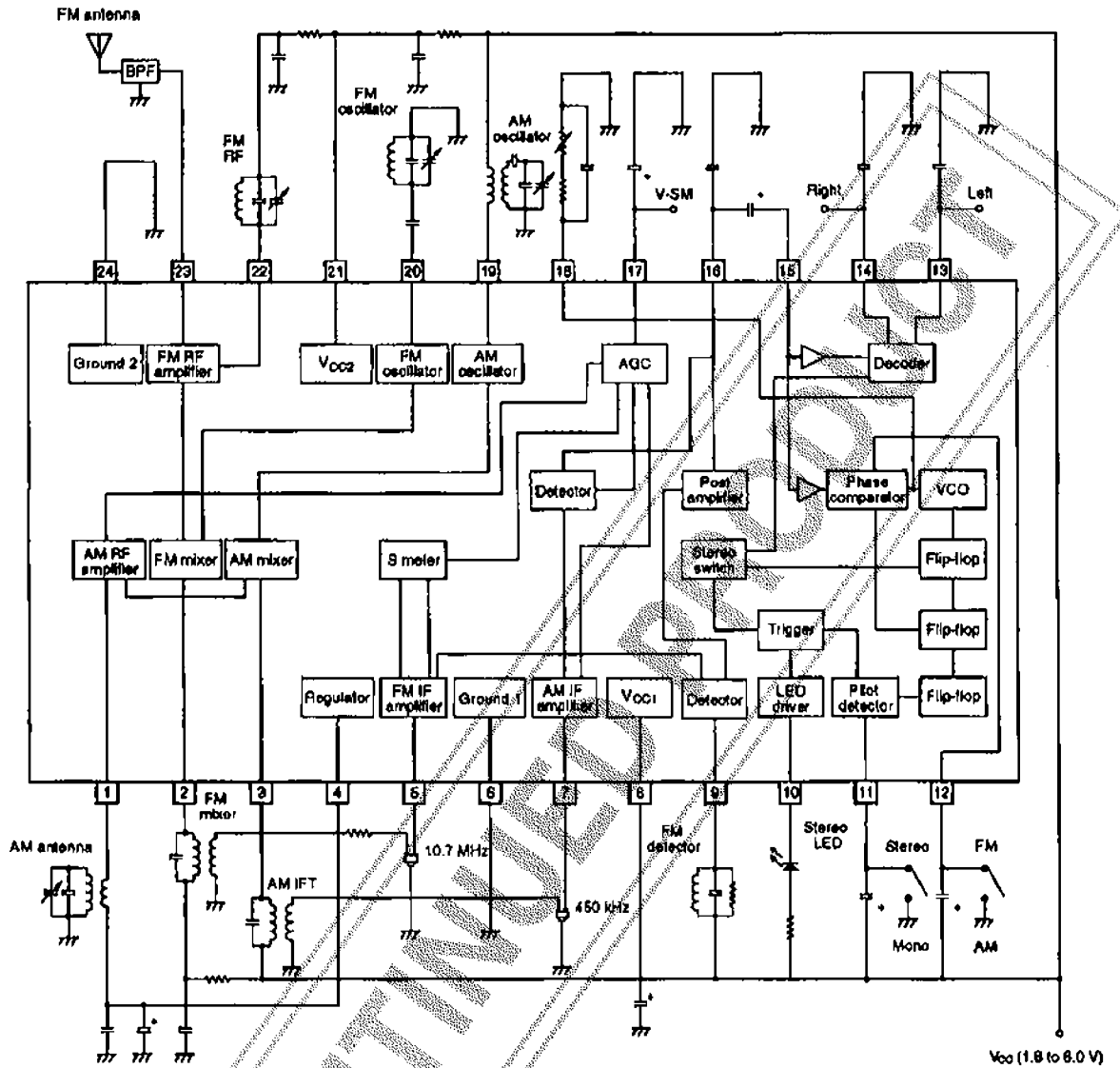

**PIN DESCRIPTION**

Number	Name	Description
1	AM ANT	AM antenna input
2	FM MIX	FM mixer output
3	AM MIX	AM mixer output
4	REG	Voltage regulator output
5	FM IF	FM IF amplifier input
6	GND 1	Ground 1
7	AM IF	AM IF amplifier input
8	VCC 1	Supply voltage 1
9	FM DET	Quadrature detection input
10	ST LED	LED driver output
11	PILOT DET	Pilot sync detect filter

Number	Name	Description
12	PHASE COMP	PLL loop filter, AM/FM change-over
13	L OUT	MPX left-channel output
14	R OUT	MPX right-channel output
15	MPX IN	MPX input
16	IF OUT	AM and FM output
17	AGC	Automatic gain control
18	MPX VCO	PLL voltage-controlled oscillator
19	AM OSC	AM oscillator input
20	FM OSC	FM oscillator input
21	VCC 2	Supply voltage 2
22	FM RF	FM RF amplifier output
23	FM ANT	FM antenna input
24	GND 2	Ground 2

## SPECIFICATIONS

### Absolute Maximum Ratings

$T_a = 25\text{ }^\circ\text{C}$

Parameter	Symbol	Rating	Unit
Supply voltage	$V_{CC}$	7	V
Supply current	$I_{CC}$	50	mA
LED output current	$I_{LEO}$	10	mA
REG output current	$I_{REG}$	0.1	mA
Power dissipation	$P_D$	350	mW
Operating temperature range	$T_{opr}$	-20 to 70	$^\circ\text{C}$
Storage temperature range	$T_{stg}$	-40 to 125	$^\circ\text{C}$

### Recommended Operating Conditions

$T_a = 25\text{ }^\circ\text{C}$

Parameter	Symbol	Rating	Unit
Supply voltage	$V_{CC}$	3	V
Supply voltage range	$V_{CC}$	1.8 to 6.0	V

### Electrical Characteristics

#### Supply current

$V_{CC} = 3\text{ V}$ ,  $T_a = 25\text{ }^\circ\text{C}$

Parameter	Symbol	Condition	Rating			Unit
			min	typ	max	
FM-mode quiescent supply current	$I_{CC(FM)}$	No input	-	13	22	mA
AM-mode quiescent supply current	$I_{CC(AM)}$	No Input	-	5	9	mA

**AM characteristics**
 $V_{CC} = 3 \text{ V}$ ,  $T_a = 25 \text{ }^\circ\text{C}$ ,  $f_c = 1 \text{ MHz}$ ,  $f_m = 1 \text{ kHz}$ 

Parameter	Symbol	Condition	Rating			Unit
			min	typ	max	
Detector output voltage	$V_o$	$V_i = 23 \text{ dB}\mu$ , 30% modulation	16	38	64	mV
		$V_i = 80 \text{ dB}\mu$ , 30% modulation	38	80	95	
Signal-to-noise ratio	S/N	$V_i = 23 \text{ dB}\mu$ , 30% modulation	14	18	-	dB
		$V_i = 80 \text{ dB}\mu$ , 30% modulation	38	46	-	
Total harmonic distortion	THD	$V_i = 80 \text{ dB}\mu$ , 30% modulation	-	0.5	1.3	%
		$V_i = 107 \text{ dB}\mu$ , 30% modulation	-	0.8	3.5	

**FM IF amplifier and MPX (mono)**
 $V_{CC} = 3 \text{ V}$ ,  $T_a = 25 \text{ }^\circ\text{C}$ ,  $f_c = 10.7 \text{ MHz}$ ,  $f_m = 1 \text{ kHz}$ ,  $V_i = 100 \text{ dB}\mu$ 

Parameter	Symbol	Condition	Rating			Unit
			min	typ	max	
-3 dB limiting sensitivity	-3dBLS	Referenced to $V_i = 100 \text{ dB}\mu$ , 100% modulation, 3 dB down	-	32	41	dB $\mu$
Demodulator output voltage	$V_o$	100% modulation	80	115	160	mV
Channel balance	CB	100% modulation	-	0	2.0	dB
Total harmonic distortion	THD	100% modulation	-	0.6	1.2	%
Signal-to-noise ratio	S/N	100% modulation	66	71	-	dB

**FM IF amplifier and MPX (stereo)**
 $V_{CC} = 3 \text{ V}$ ,  $T_a = 25 \text{ }^\circ\text{C}$ ,  $f_c = 10.7 \text{ MHz}$ ,  $f_m = 1 \text{ kHz}$ , L + R = 90%, pilot = 10%,  $V_i = 100 \text{ dB}\mu$ 

Parameter	Symbol	Condition	Rating			Unit
			min	typ	max	
Channel separation	Sep		25	35	-	dB
Total harmonic distortion	THD	Main	-	0.5	1.2	%
LED ON sensitivity	$V_{LED-ON}$	Pilot	1.7	3.5	6.3	%

**FM front-end (reference characteristics)**
 $V_{CC} = 3 \text{ V}$ ,  $T_a = 25 \text{ }^\circ\text{C}$ ,  $f_c = 98 \text{ MHz}$ ,  $f_m = 1 \text{ kHz}$ 

Parameter	Symbol	Condition	Rating			Unit
			min	typ	max	
-3 dB limiting sensitivity	-3dBLS	Referenced to $V_i = 80 \text{ dB}\mu$ , 30% modulation, 3 dB down	-	7	-	dB $\mu$
Oscillator voltage	$V_{osc}$	$f_{osc} = 108.7 \text{ MHz}$	-	150	-	mV



**COIL SPECIFICATIONS**

**FM**

Antenna bandpass filter  
RF

Sumida SNY-074-2001  
Sumida SA-149 3.6 mm diameter air-core inductor with 4½ turns of 0.6 mm wire

Oscillator

Sumida SA-151 3.6 mm diameter air-core inductor with 3½ turns of 0.6 mm wire

Mixer

Mitsumi YT-30224. When  $f_o = 10.7$  MHz,  $Q_o = 80$  and  $C = 100$  pF.

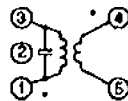

Winding	Turns
1 to 3	8
4 to 6	2

Sumida SA-165. When  $f_o = 10.7$  MHz,  $Q_o \geq 50$  and  $C = 100$  pF.



Winding	Turns
3 to 1	2
4 to 6	12

Detector

Sumida SA-179. When  $f_o = 10.7$  MHz,  $Q_o \geq 70$  and  $C = 82$  pF.



Winding	Turns
1 to 3	10

IF filter

Murata SFE10.7MS2

**MW**

Poly-varicon  
Bar antenna

Mitsumi PVC-22KTL  
Mitsumi TYA-1005. Pin 1 to pin 2 inductance is 260  $\mu$ H and  $Q_o = 360$ .

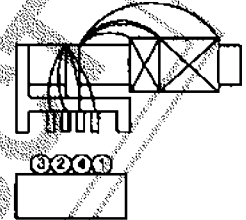

Winding	Turns
1 to 2	68
3 to 4	9

Oscillator

Mitsumi HW-6193 or Sumida SA-181. For the HW-6193,  $Q_o = 140$  and  $L = 140$   $\mu$ H, and for the SA-181,  $Q_o = 80$  and  $L = 140$   $\mu$ H.

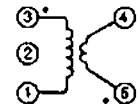

Winding	Turns	
	HW-6193	SA-181
6 to 4	32	37
3 to 1	64	74

IF tank

Mitsumi HW-6215 or Sumida SA-164. For the HW-6215, when  $f_o = 455$  kHz,  $Q_o = 110$  and  $C = 180$  pF (with SFU450B). For the SA-164, when  $f_o = 450$  kHz,  $Q_o \geq 65$  and  $C = 180$  pF.

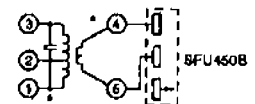

Winding	Turns	
	HW-6215	SA-164
1 to 2	94	122
4 to 6	7	9
2 to 3	58	62

IF filter

Murata SFU-450B

**SW**

Antenna

Mitsumi YT-30117. Note that  $Q_o = 95$  and  $L = 1.4 \mu\text{H}$ .

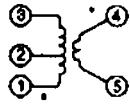

Winding	Turns
1 to 2	4
4 to 5	2
2 to 3	4

Oscillator

Mitsumi HW-40184. Note that  $Q_o \geq 28$  and  $L = 1.31 \mu\text{H}$ .



Winding	Turns
4 to 5	8
3 to 1	12

DISCONTINUED PRODUCT

TYPICAL APPLICATION

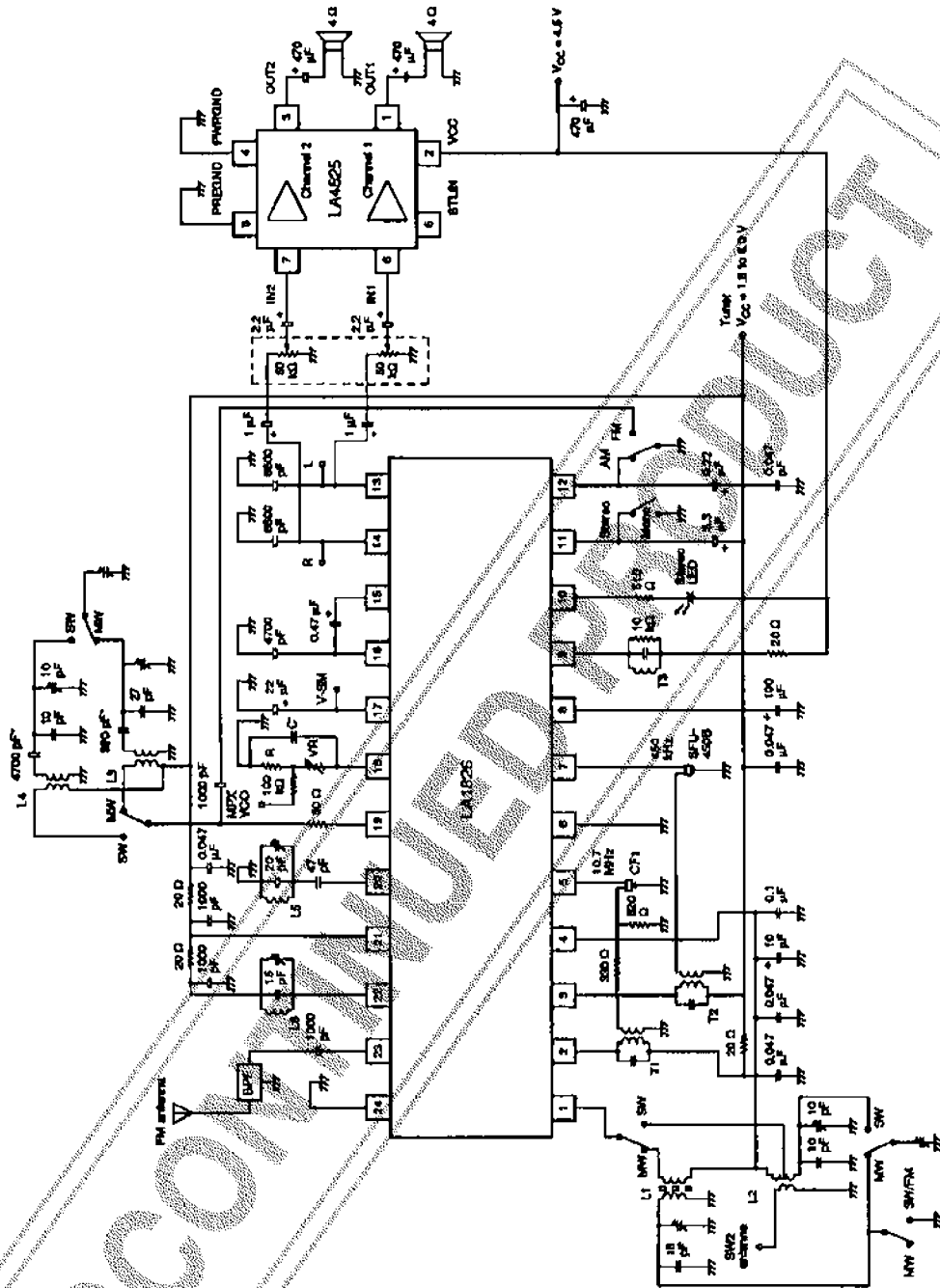

Note





\* Polystyrene film capacitor



MPX VCO Connection Component Values

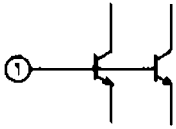
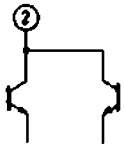
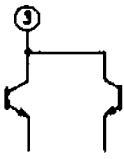
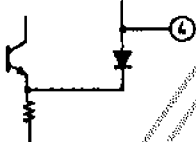
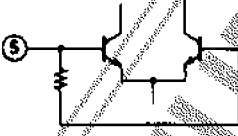

Component	V <sub>cc</sub> = 3 V	V <sub>cc</sub> = 4.5 V	V <sub>cc</sub> = 6 V
C	1000 pF	820 pF	620 pF
R	27 kΩ	33 kΩ	61 kΩ
VR	10 kΩ	20 kΩ	30 kΩ

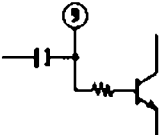

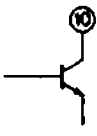
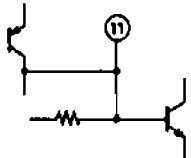
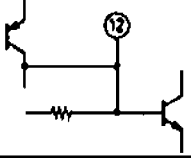
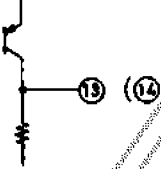
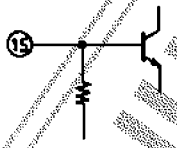
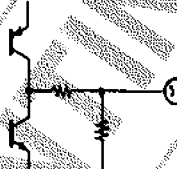
## PIN DESCRIPTION

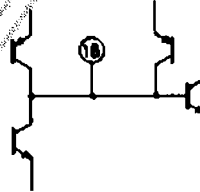
No.	Pin function	Internal equivalent circuit	Description	Quiescent voltage $V_{CC}=3.0\text{ V}$ [V]	
				AM	FM
1	AM RF input		AM antenna coil between pins 1 and 4 (regulator voltage)	1.2	1.2
2	FM mixer output		FM mixer coil between pins 2 and 8 ( $V_{CC}$ supply)	3.0	3.0
3	AM mixer output		AM IFT coil between pins 3 and 8 ( $V_{CC}$ supply)	3.0	3.0
4	Regulator voltage		$V_{reg} = 1.2\text{ V}$ regulator voltage	1.2	1.2
5	FM IF input		$r_i = 330\ \Omega$ input impedance	1.2	1.2
6	AM/FM IF/MPX ground			0	0
7	AM IF input		$r_i = 2\text{ k}\Omega$ input impedance	1.2	1.2
8	AM/FM IF/MPX supply ( $V_{CC}$ )			3.0	3.0
9	FM detector		FM detector coil between pins 9 and 8 ( $V_{CC}$ supply)	3.0	3.0

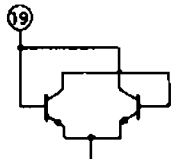
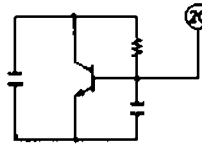
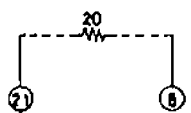
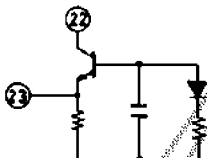
No.	Pin function	Internal equivalent circuit	Description	Quiescent voltage $V_{CC} = 3.0 \text{ V}$ [V]	
				AM	FM
10	Stereo LED		Active-Low open collector	3.0	3.0
11	Pilot detector		Forced monaural mode when pin 11 is connected to ground	1.7	2.3
12	Phase detector		FM when pin 12 is open, and AM when connected to ground	0	2.3
13	Left-channel output		$r_o = 7.5 \text{ k}\Omega$ output impedance	1.4	1.4
14	Right-channel output				
15	MPX input		$r_i = 50 \text{ k}\Omega$ output impedance	1.2	1.2
16	AM/FM demodulator output		$r_o = 20 \text{ k}\Omega$ (AM) and $r_o = 480 \Omega$ (FM) output impedance	0.3	0.7
17	AM AGC output FM S-meter output		$R = 14.6 \text{ k}\Omega$ internal load resistor	0.7	0.3
18	MPX VCO		The fixed components (R and C) vary depending on the supply voltage.	0	2.3

No.	Pin function	Internal equivalent circuit	Description	Quiescent voltage $V_{CC}=3.0\text{ V}$ [V]	
				AM	FM
19	AM oscillator		AM oscillator coil between pins 19 and 8 ( $V_{CC}$ supply)	3.0	3.0
20	FM oscillator		FM oscillator coil connection	3.0	2.7
21	FM front-end supply ( $V_{CC}$ )		20 $\Omega$ external resistor connection	3.0	2.9
22	FM RF output		FM RF coil between pins 22 and 23 (front-end $V_{CC}$ supply) $r_i = 430\ \Omega$ input impedance	3.0	2.8
23	FM RF input				
24	FM front-end ground			0	0

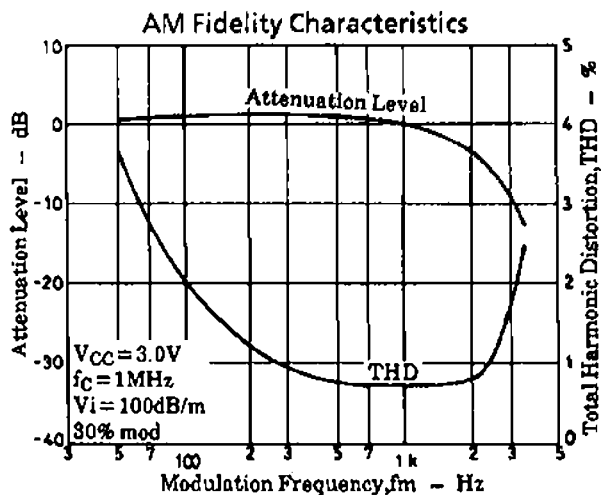
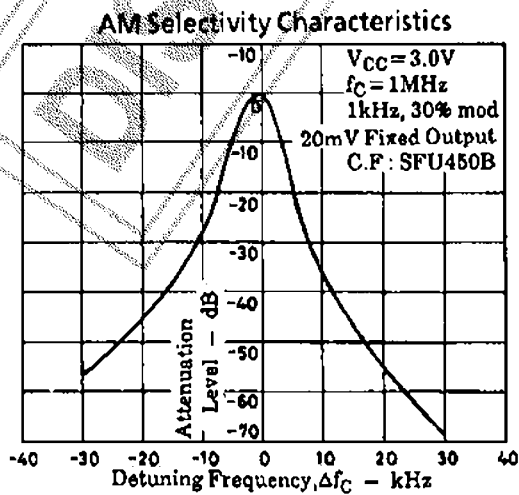
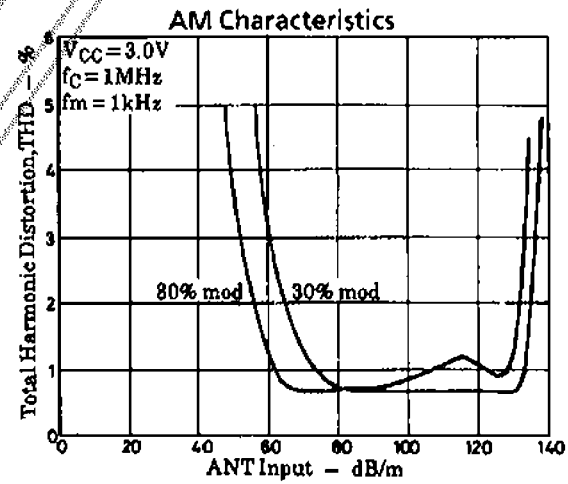
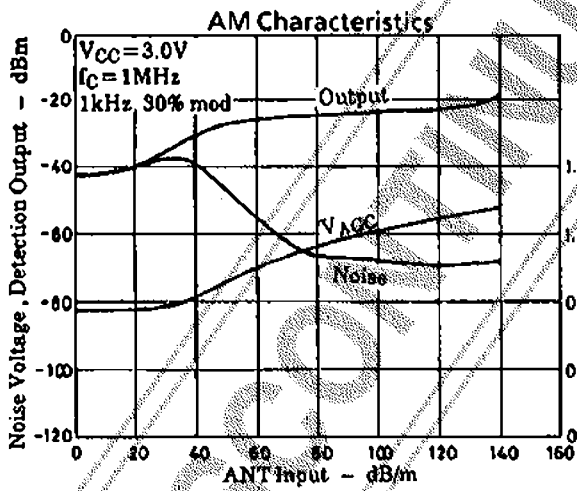
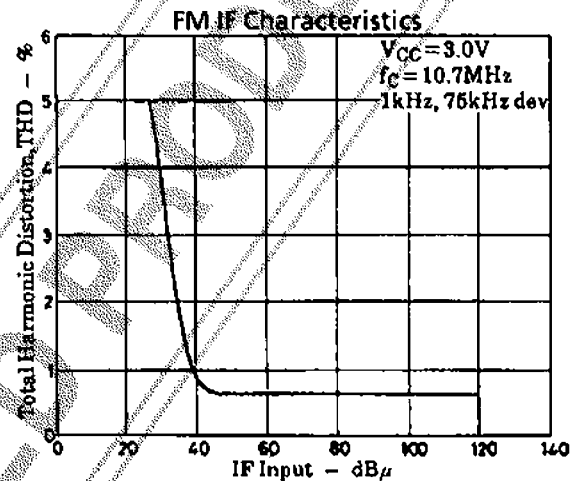
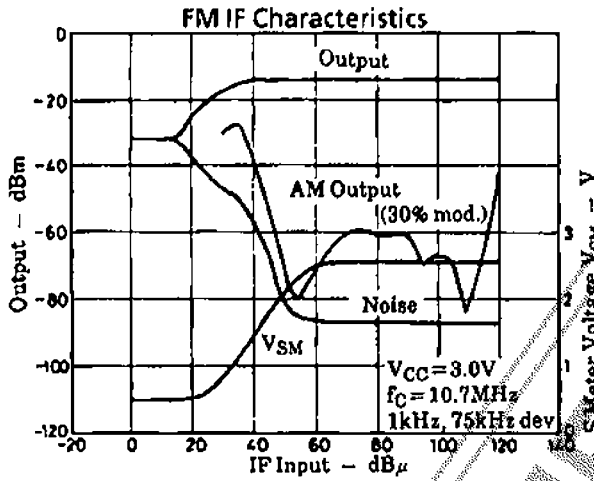
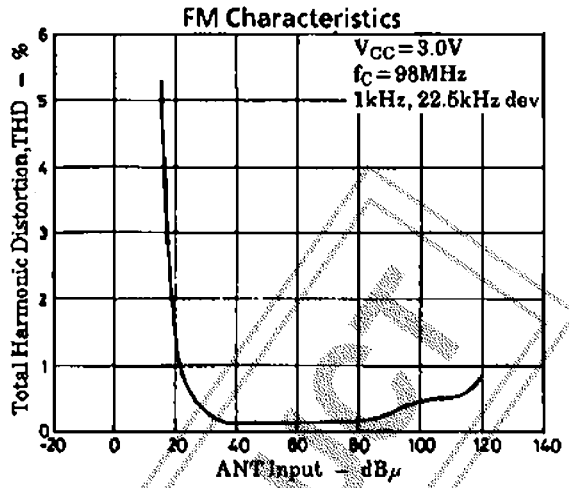
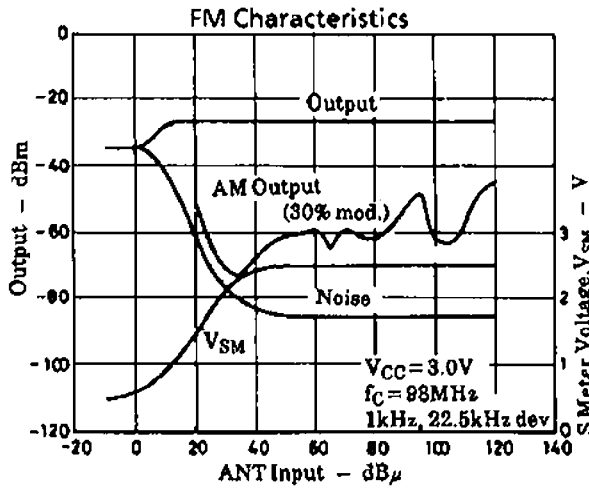

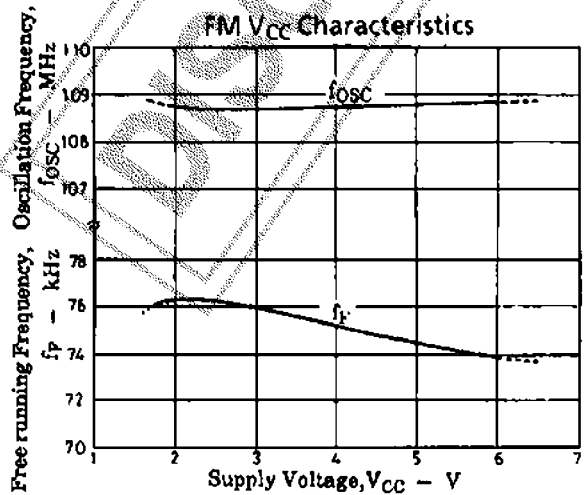
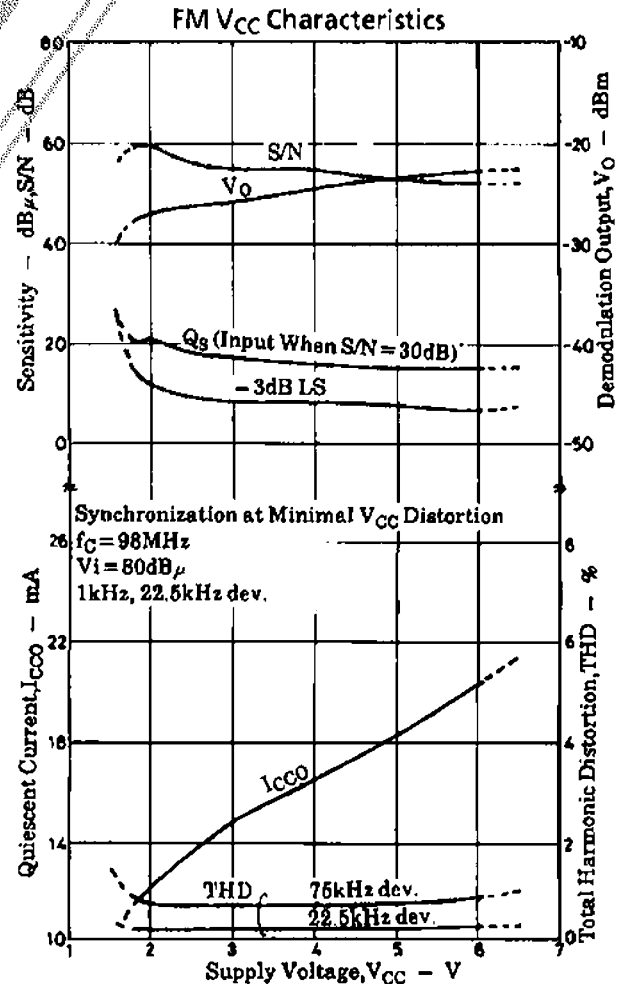
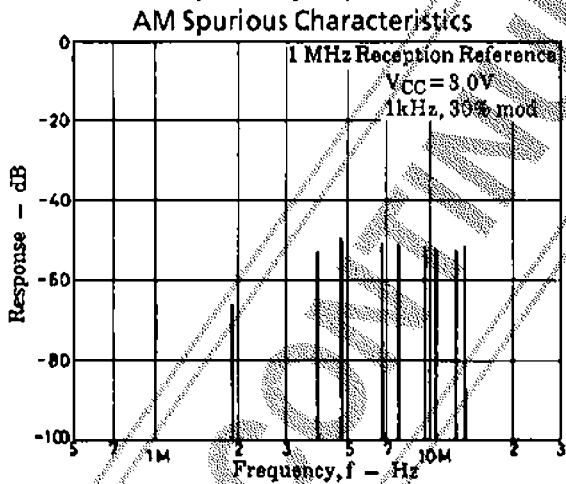
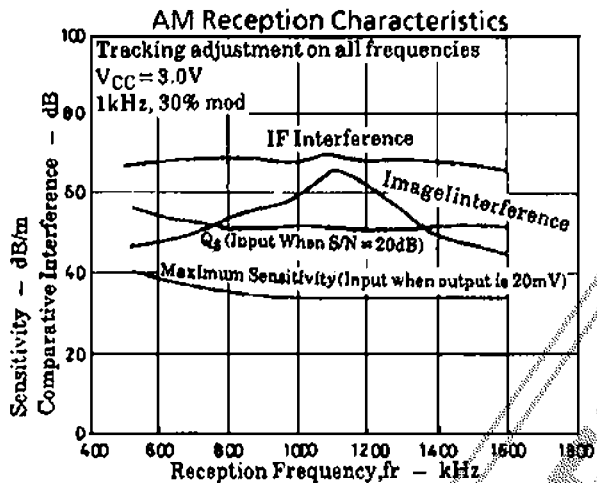
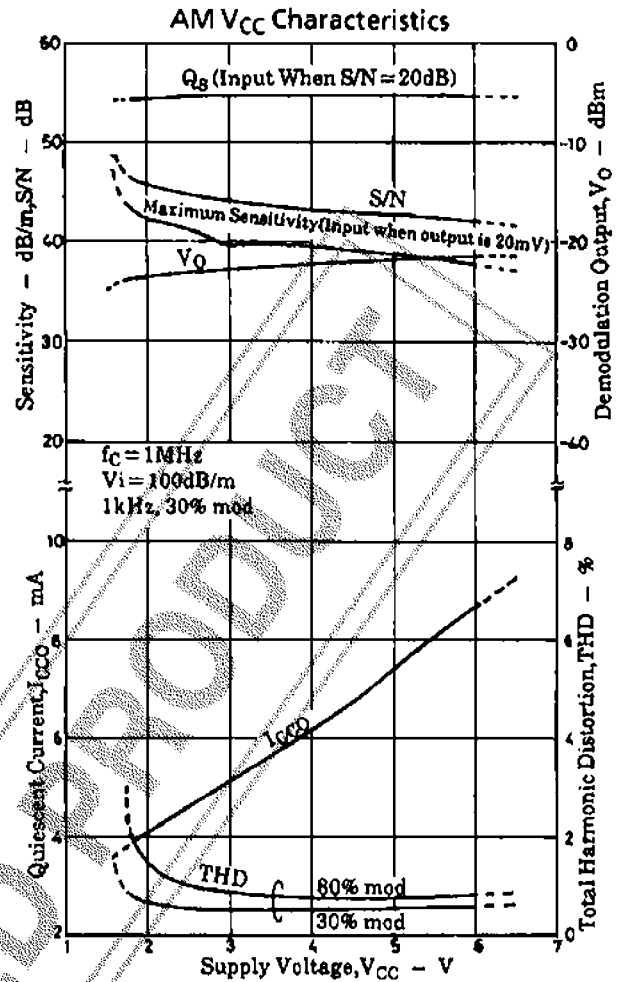
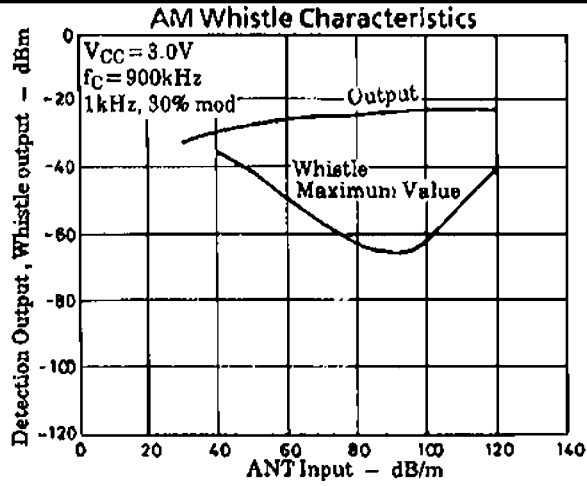

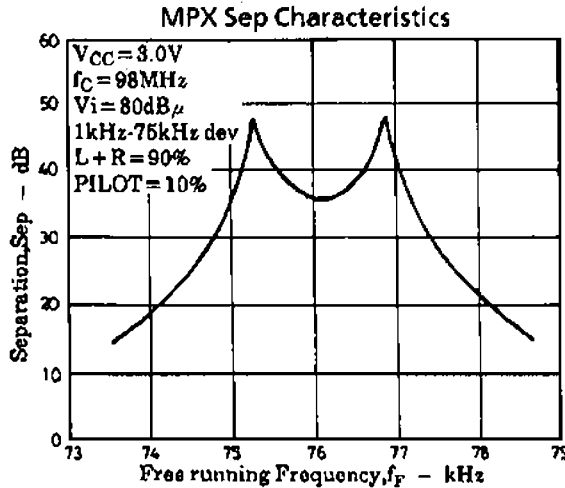
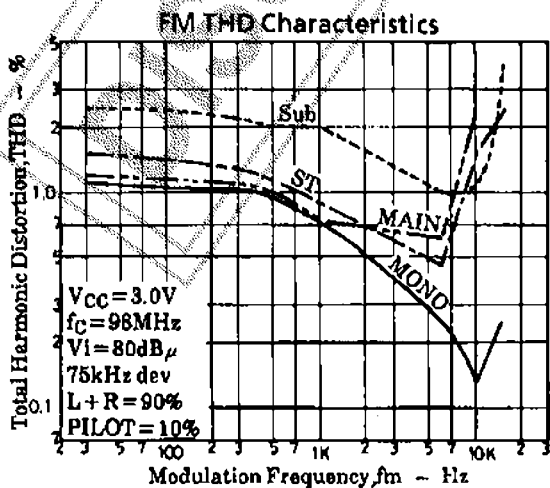
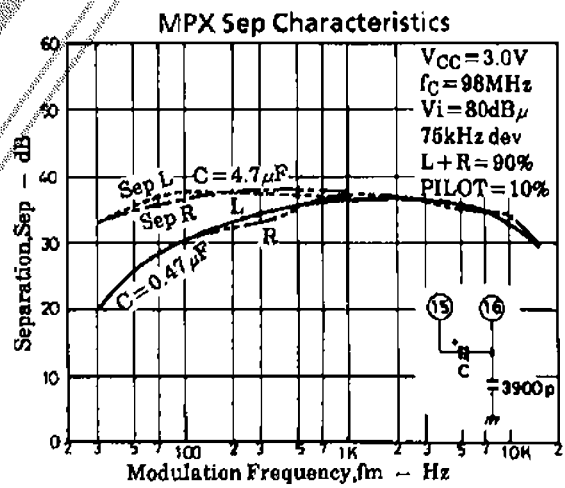
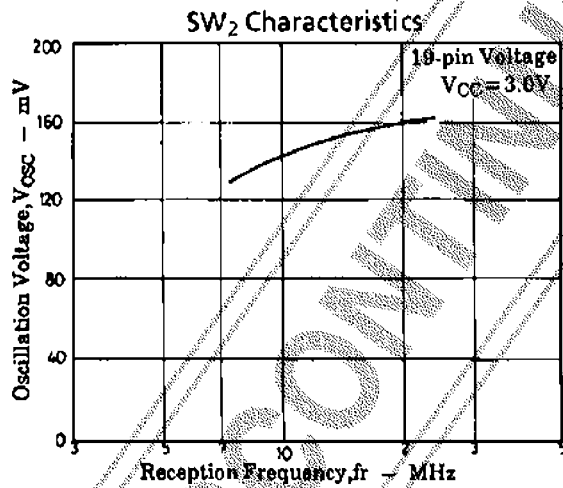
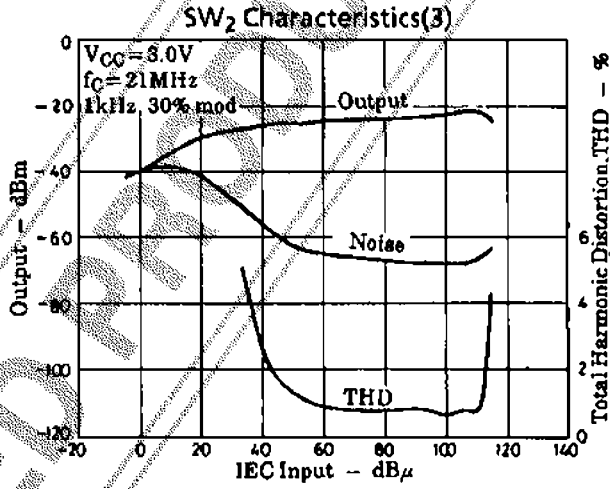
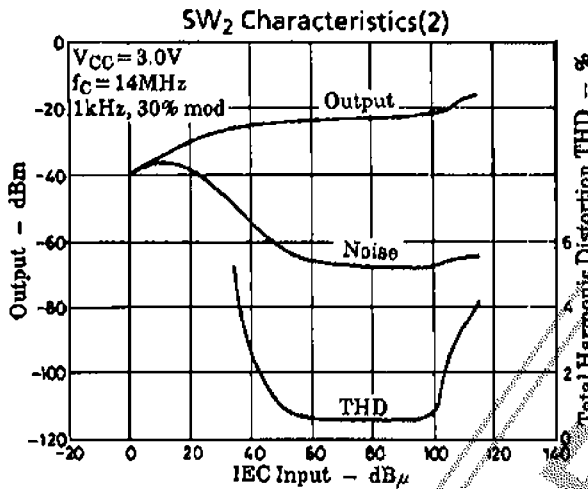
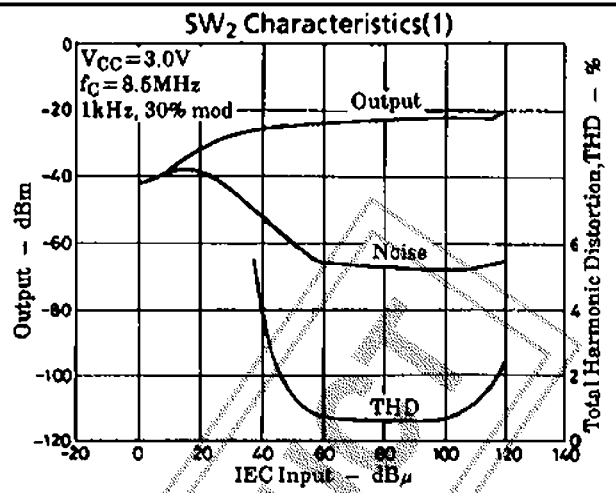
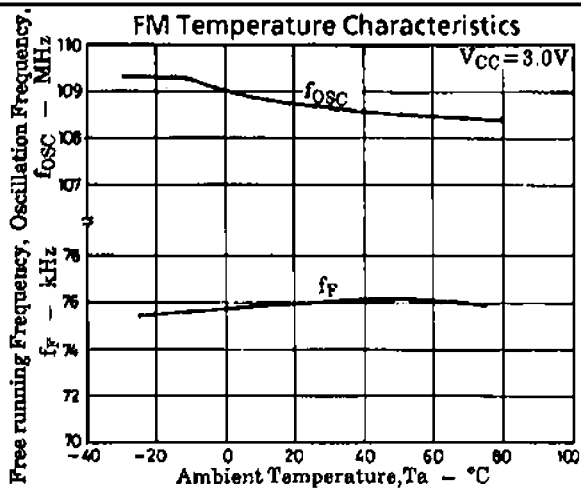

MPX Capture Range Characteristics

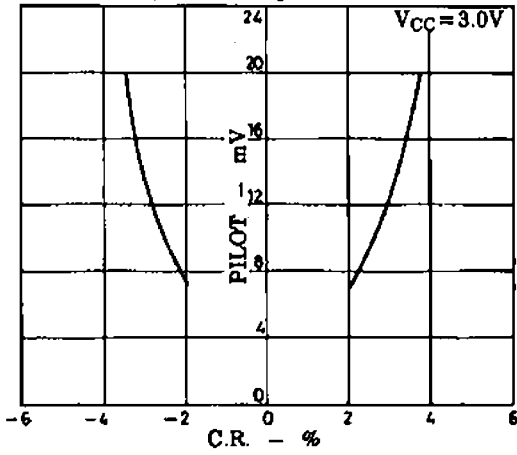

MPX V<sub>CC</sub> Characteristics(1)

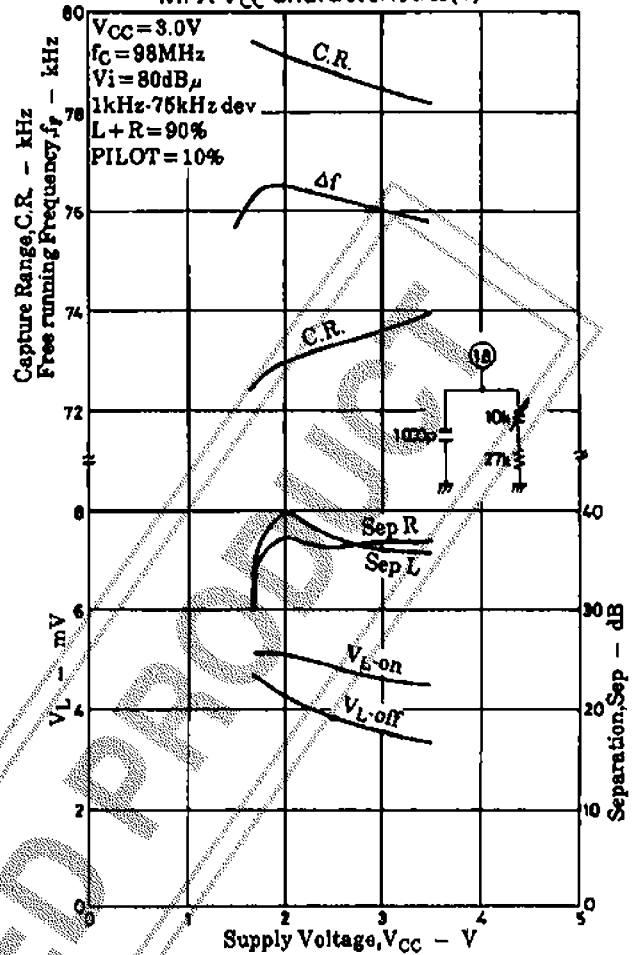

MPX THD-Vi Characteristics

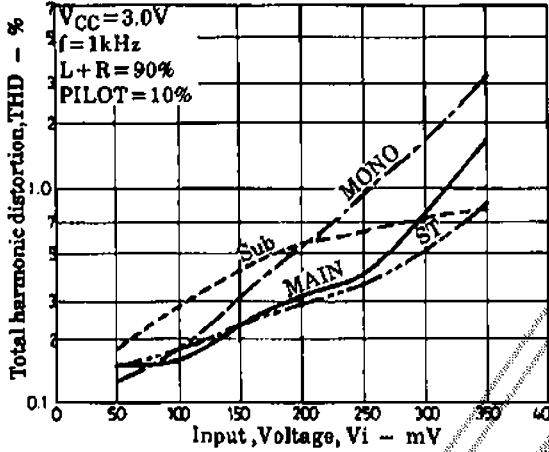

MPX V<sub>CC</sub> Characteristics(2)

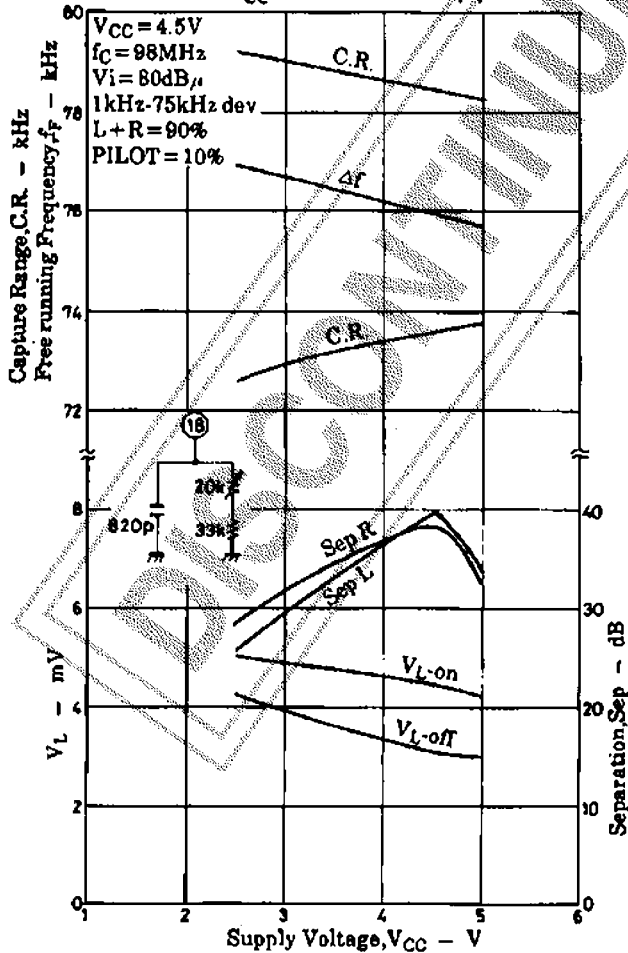

MPX V<sub>CC</sub> Characteristics(3)

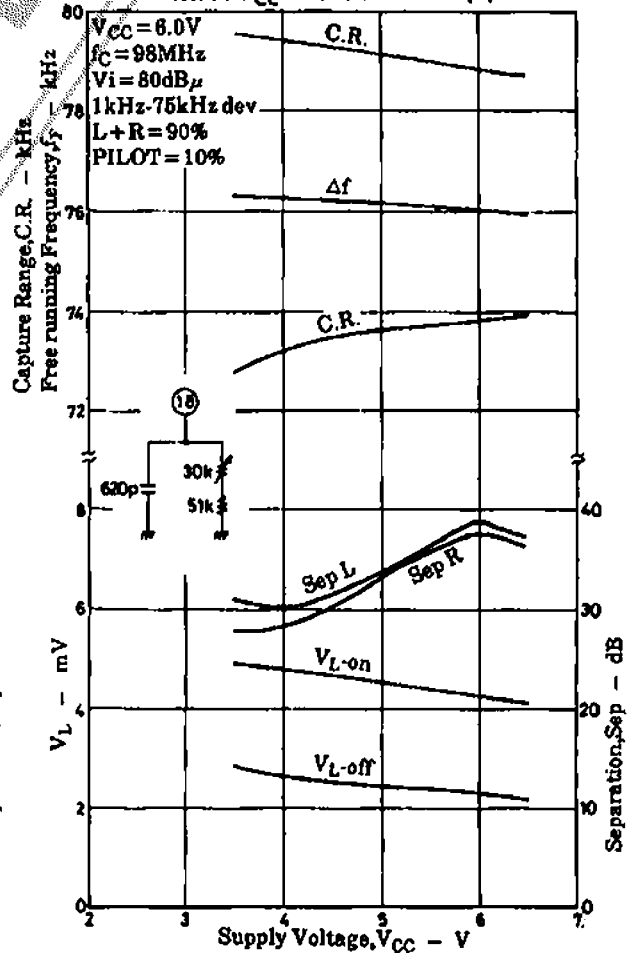

- No products described or contained herein are intended for use in surgical implants, life-support systems, aerospace equipment, nuclear power control systems, vehicles, disaster/crime-prevention equipment and the like, the failure of which may directly or indirectly cause injury, death or property loss.
- Anyone purchasing any products described or contained herein for an above-mentioned use shall:
- ① Accept full responsibility and indemnify and defend SANYO ELECTRIC CO., LTD., its affiliates, subsidiaries and distributors and all their officers and employees, jointly and severally, against any and all claims and litigation and all damages, cost and expenses associated with such use;
  - ② Not impose any responsibility for any fault or negligence which may be cited in any such claim or litigation on SANYO ELECTRIC CO., LTD., its affiliates, subsidiaries and distributors or any of their officers and employees jointly or severally.
- Information (including circuit diagrams and circuit parameters) herein is for example only; it is not guaranteed for volume production. SANYO believes information herein is accurate and reliable, but no guarantees are made or implied regarding its use or any infringements of intellectual property rights or other rights of third parties.