

# KA2S0765

# SAMSUNG POWER SWITCH

## FEATURES

- Wide operating frequency range up to 150KHz
- Pulse by pulse over current limiting
- Over load protection
- Over voltage protection (min:23V)
- Internal thermal shutdown function
- Under voltage lockout
- Internal high voltage sense FET
- External sync terminal
- Latch Mode

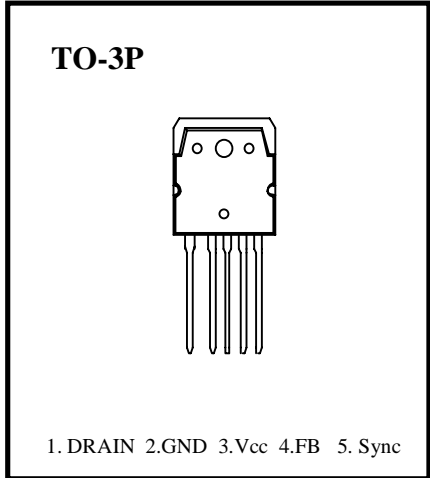

## PRODUCT SUMMARY

Part Number	BVdss	Rds(on)	Id
KA2S0765	650V	1.6Ω	7A

## BLOCK DIAGRAM

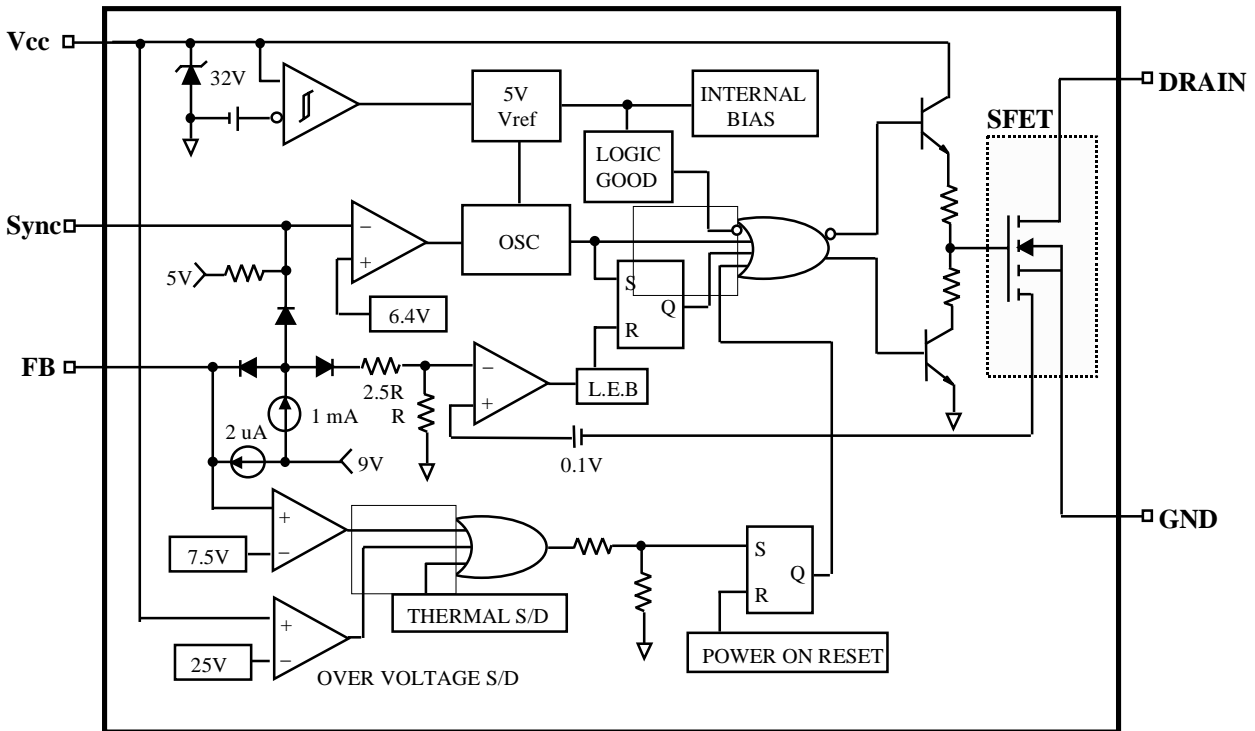

## ABSOLUTE MAXIMUM RATINGS

Characteristic	Symbol	Value	Unit
Drain - Source(GND) Voltage (1)	V <sub>DSS</sub>	650	V
Drain - Gate Voltage (R <sub>GS</sub> = 1MΩ)	V <sub>DGR</sub>	650	V
Gate - Source(GND) Voltage	V <sub>GS</sub>	±30	V
Drain Current Pulsed (2)	I <sub>DM</sub>	28.0	A <sub>DC</sub>
Single Pulsed Avalanche Energy (3)	E <sub>AS</sub>	570	mJ
Avalanche Current	I <sub>AS</sub>	-	A
Continuous Drain Current (T <sub>c</sub> = 25 °C)	I <sub>D</sub>	7.0	A <sub>DC</sub>
Continuous Drain Current (T <sub>c</sub> = 100 °C)	I <sub>D</sub>	5.6	A <sub>DC</sub>
Supply Voltage	V <sub>CC</sub>	30	V
Analog Input Voltage Range	V <sub>FB</sub>	-0.3 ~ V <sub>SD</sub>	V
Total Power Dissipation	P <sub>D</sub> ( wt H/S)	140	W
	Derating	1.11	W/°C
Operating Temperature	T <sub>OPR</sub>	- 25 ~ + 85	°C
Storage Temperature	T <sub>STG</sub>	- 55 ~ + 150	°C

Notes: (1) T<sub>J</sub> = 25 °C to 150 °C

(2) Repetitive rating : Pulse width limited by maximum junction temperature

(3) L = 24mH, V<sub>DD</sub> = 50V, R<sub>G</sub> = 25Ω, starting T<sub>j</sub> = 25 °C

## ELECTRICAL CHARACTERISTICS ( SFET part )

( T<sub>a</sub> = 25 °C unless otherwise specified )

Symbol	Characteristic	Min	Typ	Max	Units	Test Conditions
BV <sub>DSS</sub>	Drain-Source Breakdown Voltage	650	-	-	V	V <sub>GS</sub> =0V, I <sub>D</sub> =50uA
I <sub>DSS</sub>	Zero Gate Voltage Drain Current	-	-	50	uA	V <sub>DS</sub> =Max, Rating, V <sub>GS</sub> =0V
		-	-	200	uA	V <sub>DS</sub> =0.8Max, Rating, V <sub>GS</sub> =0V TC=125 °C
R <sub>DS(on)</sub>	Static Drain-Source On Resistance(4)	-	1.25	1.6	Ω	V <sub>GS</sub> = 10V, I <sub>D</sub> = 4.0A

**ELECTRICAL CHARACTERISTICS ( SFET part continued)**

( Ta = 25 °C unless otherwise specified )

Symbol	Characteristic	Min	Typ	Max	Units	Test Conditions
$g_{fs}$	Forward Transconductance(4)	3.0	-	-	mho	$V_{DS}=15V, I_D=4.0A$
$C_{iss}$	Input Capacitance	-	1600	-	pF	$V_{GS} = 0V, V_{DS} = 25V,$ $f = 1MHz$
$C_{oss}$	Output Capacitance	-	310	-		
$C_{rss}$	Reverse Transfer Capacitance	-	120	-		
$t_{d(on)}$	Turn On Delay Time	-	25	-	nS	$V_{DD} = 0.5BV_{DSS}, I_D = 7.0A$ (MOSFET switching time are essentially independent of operating temperature )
$t_r$	Rise Time	-	55	-		
$t_{d(off)}$	Turn Off Delay Time	-	80	-		
$t_f$	Fall Time	-	50	-		
$Q_g$	Total Gate Charge ( Gate-Source + Gate-Drain )	-	-	72	nC	$V_{GS} = 10V, I_D = 7.0A$ $V_{DS} = 0.5BV_{DSS}$ (MOSFET switching time are essentially independent of operating temperature )
$Q_{gs}$	Gate-Source Charge	-	9.3	-		
$Q_{gd}$	Gate-Drain(Miller) Charge	-	29.3	-		

**Notes:** (1)  $T_J = 25^\circ C$  to  $150^\circ C$ 

(2) Repetitive rating : Pulse width limited by maximum junction temperature

(3)  $L = 24mH, V_{DD} = 50V, R_G = 25\Omega,$  starting  $T_j = 25^\circ C$ (4) Pulse Test : Pulse width  $\leq 300\mu s,$  Duty Cycle  $\leq 2\%$

**ELECTRICAL CHARACTERISTICS ( Control part )**

( Ta = 25 °C unless otherwise specified )

Symbol	Characteristics	Min	Typ	Max	Unit	Test Conditions
<b>REFERENCE SECTION</b>						
Vref	Output Voltage (Note 1)	4.80	5.00	5.20	V	Ta = 25 °C
Vref / ΔT	Temperature Stability (Note 1&2)	-	0.3	0.6	mV/°C	-25 °C ≤ Ta ≤ +85 °C
<b>OSCILLATOR SECTION</b>						
FOSC	Initial Accuracy	18	20	22	KHz	Ta = 25 °C
ΔF / ΔT	Frequency Change with Temperature (Note 2)		±5	±10	%	-25 °C ≤ Ta ≤ +85 °C
VSYTH	Sync Threshold Voltage	6.0	6.4	6.8	V	Vfb = 5 V
<b>DMAX SECTION</b>						
DMAX	Maximum Duty Cycle	92	95	98	%	
<b>FEEDBACK SECTION</b>						
IFB	Feedback Source Current	0.7	0.9	1.1	mA	Ta = 25 °C, Vfb = GND
Idelay	Shutdown Delay Current	1.4	1.8	2.2	uA	Ta = 25 °C, 5 V ≤ Vfb ≤ VSD
<b>OVER CURRENT PROTECTION SECTION</b>						
IL(MAX)	Over Current Protection	4.4	5.00	5.6	A	Max. Inductor Current
<b>UVLO SECTION</b>						
Vth(H)	Start Threshold Voltage	14	15	16	V	
Vth(L)	Minimum Operating Voltage	9	10	11	V	After turn on

**ELECTRICAL CHARACTERISTICS ( Continued)**

( Ta = 25 °C unless otherwise specified )

Symbol	Characteristics	Min	Typ	Max	Unit	Test Conditions
<b>TOTAL STANDBY CURRENT SECTION</b>						
I <sub>ST</sub>	Start up Current	0.1	0.3	0.55	mA	V <sub>CC</sub> = 14V
I <sub>OPR</sub>	Operating Supply Current ( control part only )	6	12	18	mA	Ta = 25 °C ,
V <sub>Z</sub>	V <sub>CC</sub> Zener Voltage	30	32.5	35	V	I <sub>CC</sub> = 20mA
<b>SHUTDOWN SECTION</b>						
V <sub>SD</sub>	Shutdown Feedback Voltage	6.9	7.5	8.1	V	
T <sub>SD</sub>	ThermalShutdownTemperature(T <sub>j</sub> )	140	160	-	°C	(Note 1)
V <sub>ovp</sub>	Over Voltage Protection	23	25	28		
<b>SOFT START SECTION</b>						
I <sub>SS</sub>	Soft Start Current	0.8	1.0	1.2	mA	Sync&S/S = GND
V <sub>SS</sub>	Soft Start Voltage	4.7	5.0	5.3	V	V <sub>FB</sub> = 2V

- Notes:** (1) These parameters, although guaranteed, are not 100% tested in production  
(2) These parameters, although guaranteed, are tested in EDS(wafer test) process.

**TYPICAL PERFORMANCE CHARACTERISTICS**

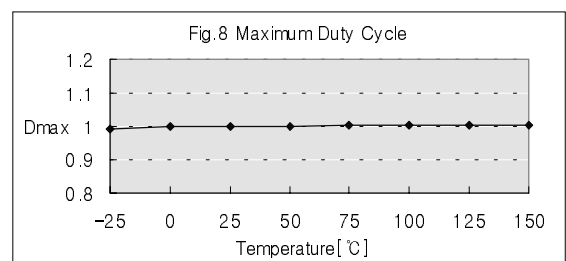
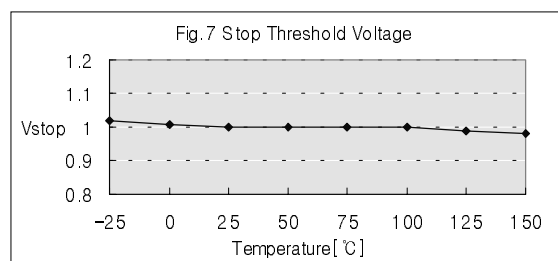
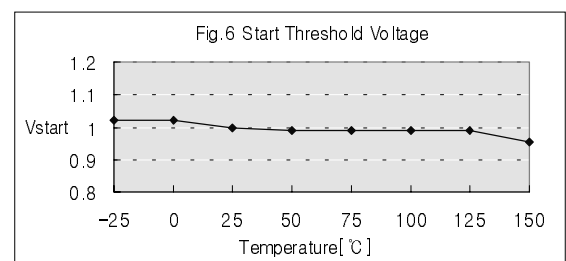
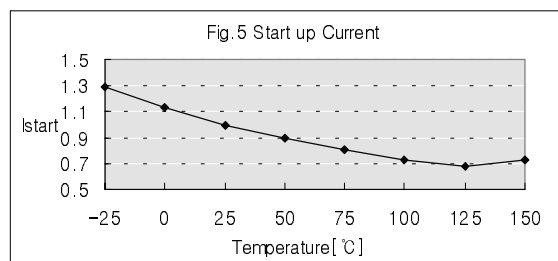
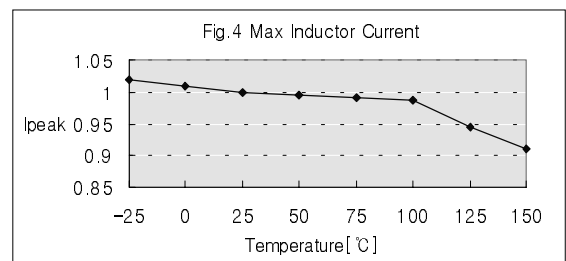
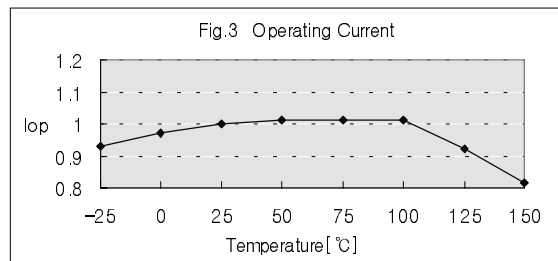
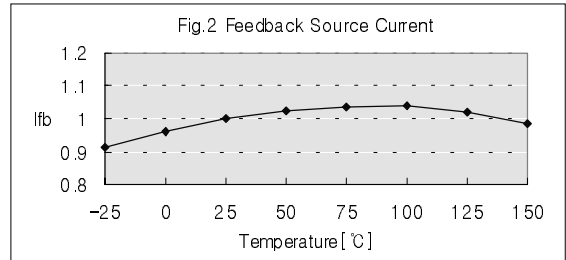
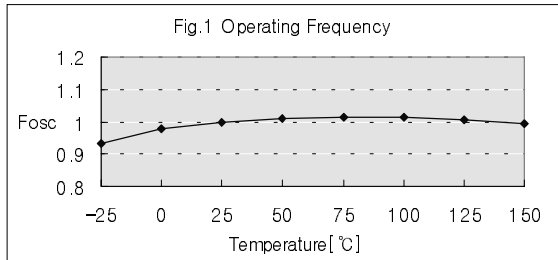

**TYPICAL PERFORMANCE CHARACTERISTICS (Continued)**

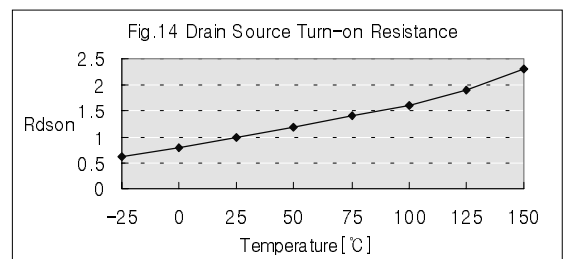
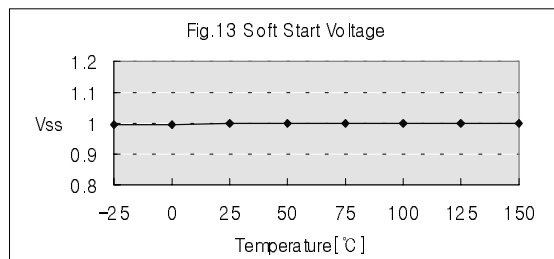
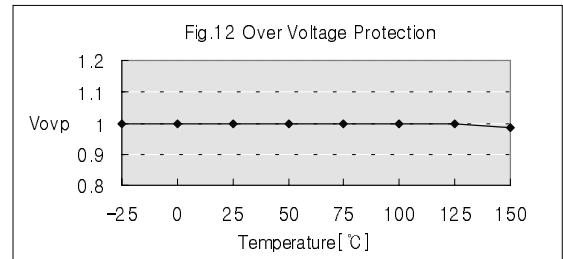
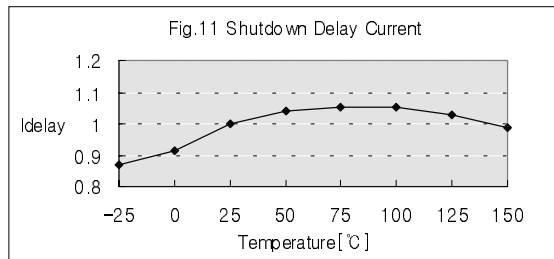
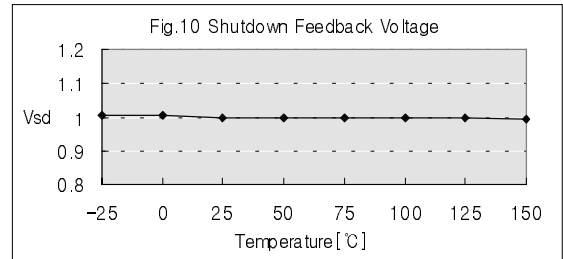
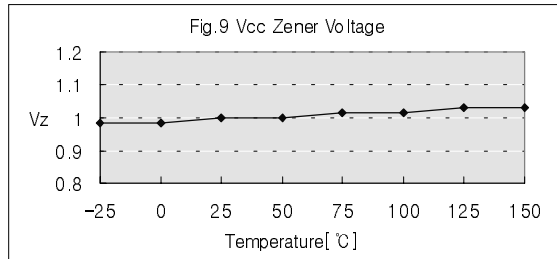

# TO-3P

Dimensions in Millimeters

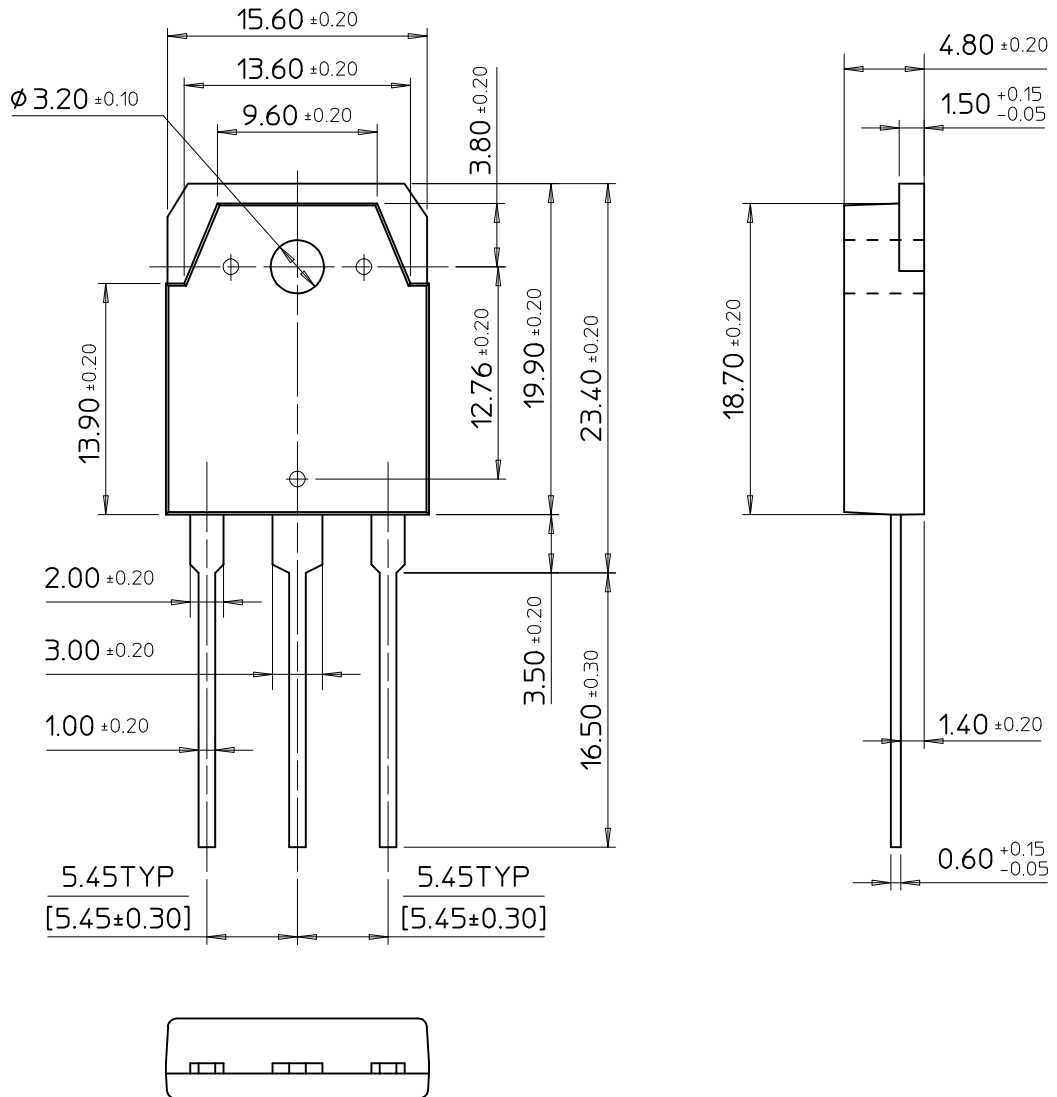

SAMSUNG ELECTRONICS CO.,LTD.