

FS6S-SERIES

FS6S0965R/FS6S0965RT/FS6S1265R/FS6S15658R

Fairchild Power Switch(SPS)

Features

- Wide Operating Frequency Range Up to 150Khz
- Lowest Cost SMPS Solution
- Lowest External Components
- Low Start-up Current (max:170uA)
- Low Operating Current (max:15mA)
- Internal High Voltage SenseFET
- Built-in Auto-Restart Circuit
- Over Voltage Protection (Auto Restart Mode)
- Over Load Protection (Auto Restart Mode)
- Over Current Protection With Latch Mode
- Internal Thermal Protection With Latch Mode
- Pulse By Pulse Over Current Limiting
- Internal Burst Mode Controller for Stand-by Mode
- Under Voltage Lockout With Hysteresis
- External Sync. Terminal

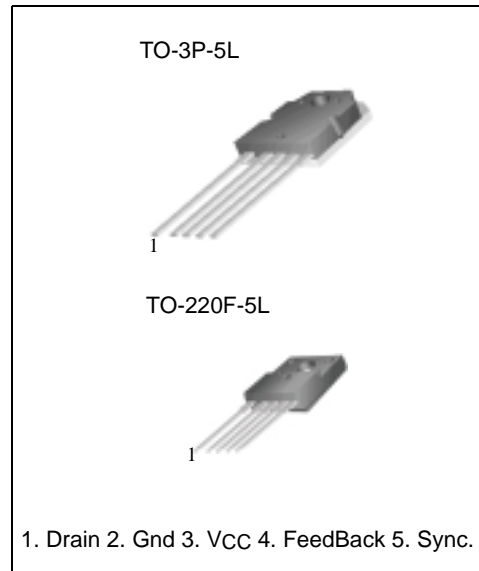

Internal Block Diagram

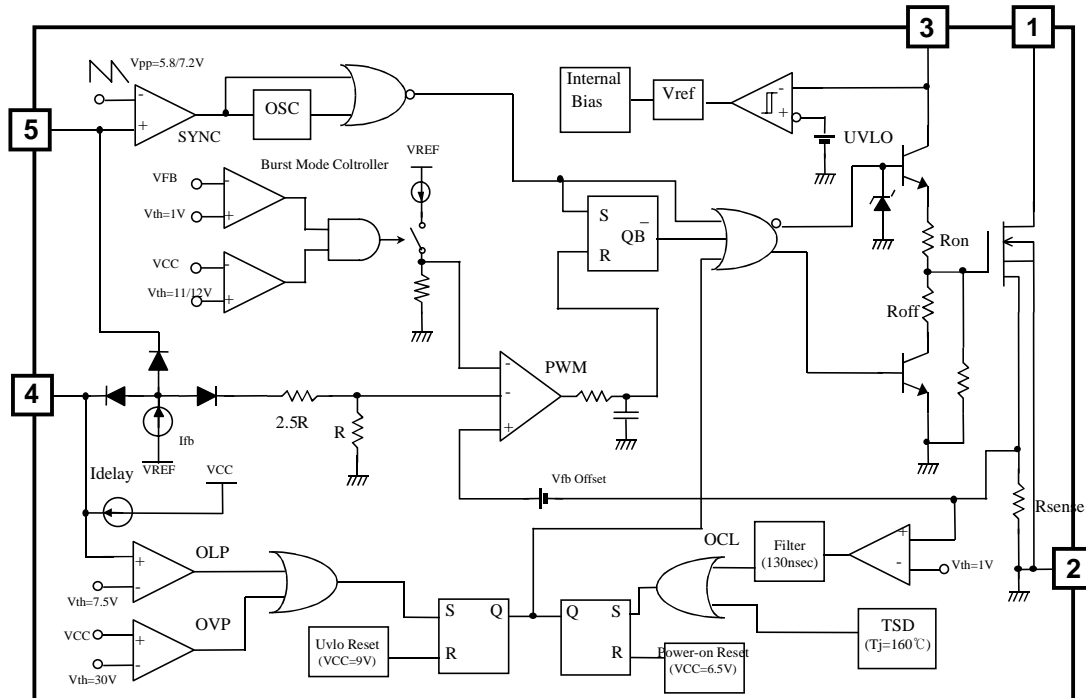

Absolute Maximum Ratings

(Ta=25 C, unless otherwise specified)

Characteristic	Symbol	Value		Unit
FS6S0965RT/FS6S0965R				
Drain to PKG Breakdown Voltage	BV _{PKG}	FS6S0965RT	3500	V
Maximum Drain Voltage	V _{D,MAX}	650		V
Drain-Gate Voltage(RGS=1M	V _{DGR}	650		V
Gate-Source(GND) Voltage	V _{GS}	±30		V
Drain Current Pulsed ⁽¹⁾	I _{DM}	36		ADC
Continuous Drain Current (Tc = 25 C)	I _D	9		ADC
Continuous Drain Current (Tc = 100 C)	I _D	7.2		ADC
Single Pulsed Avalanch Current(Energy ⁽²⁾)	I _{AS(EAS)}	25(950)		A(mJ)
Maximum Supply Voltage	V _{CC,MAX}	35		V
Input Voltage Range	V _{FB}	-0.3 to V _{CC}		V
	V _{SS}	-0.3 to 10		V
Total Power Dissipation	P _D (Watt H/S)	FS6S0965RT	48	W
		FS6S0965R	170	
	Derating	FS6S0965RT	0.385	W / C
		FS6S0965R	1.33	
Operating Junction Temperature.	T _J	+160		C
Operating Ambient Temperature.	T _A	-25 to +85		C
Storage Temperature Range.	T _{STG}	-55 to +150		C

FS6S1265R				
Maximum Drain Voltage	V _{D,MAX}	650		V
Drain-Gate Voltage(RGS=1M	V _{DGR}	650		V
Gate-Source(GND) Voltage	V _{GS}	±30		V
Drain Current Pulsed ⁽¹⁾	I _{DM}	48		ADC
Continuous Drain Current (Tc = 25 C)	I _D	12		ADC
Continuous Drain Current (Tc = 100 C)	I _D	8.4		ADC
Single Pulsed Avalanch Current(Energy ⁽²⁾)	I _{AS(EAS)}	30(950)		A(mJ)
Maximum Supply Voltage	V _{CC,MAX}	35		V
Input Voltage Range	V _{FB}	-0.3 to V _{CC}		V
	V _{SS}	-0.3 to 10		V
Total Power Dissipation	P _D (Watt H/S)	240		W
	Derating	1.92		W / C
Operating Junction Temperature.	T _J	+160		C
Operating Ambient Temperature.	T _A	-25 to +85		C
Storage Temperature Range.	T _{STG}	-55 to +150		C

Absolute Maximum Ratings (Continued)

(Ta=25 C, unless otherwise specified)

Characteristic	Symbol	Value	Unit
FS6S15658R			
Maximum Drain Voltage	V _{D,MAX}	650	V
Drain-Gate Voltage(R _{GS} =1M)	V _{DGR}	650	V
Gate-Source(GND) Voltage	V _{GS}	±30	V
Drain Current Pulsed ⁽¹⁾	I _{DM}	60	ADC
Continuous Drain Current (T _c = 25 C)	I _D	15	ADC
Continuous Drain Current (T _c = 100 C)	I _D	12.0	ADC
Single Pulsed Avalanche Current(Energy ⁽²⁾)	I _{AS} (EAS)	37(--)	A(mJ)
Maximum Supply Voltage	V _{CC,MAX}	35	V
Input Voltage Range	V _{FB}	-0.3 to V _{CC}	V
	V _{SS}	-0.3 to 10	V
Total Power Dissipation	P _D (Watt H/S)	280	W
	Derating	2.22	W / C
Operating Junction Temperature.	T _J	+160	C
Operating Ambient Temperature.	T _A	-25 to +85	C
Storage Temperature Range.	T _{STG}	-55 to +150	C

Notes :

1. Repetitive rating : Pulse width limited by maximum junction temperature
2. L = 10mH, V_{DD} =50V, R_G = 27 Ω , starting T_j = 25 C
3. L = 13uH, starting T_j = 25 C

Electrical Characteristics (SFET Part)

(Ta = 25 C unless otherwise specified)

Parameter	Symbol	Conditions	Min.	Typ.	Max.	Unit
FS6S0965RT/FS6S0965R						
Drain-Source Breakdown Voltage	BVDSS	VGS=0V, ID=50 A	650	-	-	V
Zero Gate Voltage Drain Current	IDSS	VDS=Max., Rating, VGS=0V	-	-	200	A
		VDS=0.8Max., Rating, VGS=0V, TC=125 C	-	-	300	A
Static Drain-Source On Resistance ⁽¹⁾	RDS(on)	VGS=10V, ID=4.5A	-	1.1	1.2	
Forward transconductance ⁽¹⁾	gfs	VDS=50V, ID=4.5A	-	-	-	S
Input capacitance	Ciss	VGS=0V, VDS=25V, f = 1MHz	-	1300	-	pF
Output capacitance	Coss		-	135	-	
Reverse transfer capacitance	Crss		-	25	-	
Turn on delay time	td(on)	VDD=0.5BVDSS, ID=9.0A (MOSFET switching time are essentially independent of operating temperature)	-	25	-	nS
Rise time	tr		-	75	-	
Turn off delay time	td(off)		-	130	-	
Fall time	tf		-	70	-	
Total gate charge (gate-source+gate-drain)	Qg	VGS=10V, ID=9.0A, VDS=0.5BVDSS(MOSFET Switching time are Essentially independent of Operating temperature)	-	45	-	nC
Gate-source charge	Qgs		-	8	-	
Gate-drain (Miller) charge	Qgd		-	22	-	
FS6S1265R						
Drain-Source Breakdown Voltage	BVDSS	VGS=0V, ID=50 A	650	-	-	V
Zero Gate Voltage Drain Current	IDSS	VDS=Max., Rating, VGS=0V	-	-	200	A
		VDS=0.8Max., Rating, VGS=0V, TC=125 C	-	-	300	A
Static Drain-Source On Resistance ⁽¹⁾	RDS(on)	VGS=10V, ID=4.5A	-	0.7	0.9	
Forward transconductance ⁽¹⁾	gfs	VDS=50V, ID=4.5A	-	-	-	S
Input capacitance	Ciss	VGS=0V, VDS=25V, f = 1MHz	-	1820	-	pF
Output capacitance	Coss		-	185	-	
Reverse transfer capacitance	Crss		-	32	-	
Turn on delay time	td(on)	VDD=0.5BVDSS, ID=12.0A (MOSFET switching time are essentially independent of operating temperature)	-	38	-	nS
Rise time	tr		-	120	-	
Turn off delay time	td(off)		-	200	-	
Fall time	tf		-	100	-	
Total gate charge (gate-source+gate-drain)	Qg	VGS=10V, ID=12.0A, VDS=0.5BVDSS(MOSFET Switching time are Essentially independent of Operating temperature)	-	60	-	nC
Gate-source charge	Qgs		-	10	-	
Gate-drain (Miller) charge	Qgd		-	30	-	

Electrical Characteristics (SFET Part; Continued)

(Ta = 25 C unless otherwise specified)

Parameter	Symbol	Conditions	Min.	Typ.	Max.	Unit
FS6S15658R						
Drain-Source Breakdown Voltage	BVDSS	VGS=0V, ID=50 A	650	-	-	V
Zero Gate Voltage Drain Current	IDSS	VDS=Max., Rating, VGS=0V	-	-	200	A
		VDS=0.8Max., Rating, VGS=0V, TC=125 C	-	-	300	A
Static Drain-Source On Resistance ⁽¹⁾	RDS(on)	VGS=10V, ID=4.5A	-	0.5	0.65	
Forward transconductance ⁽¹⁾	gfs	VDS=50V, ID=4.5A	-	-	-	S
Input capacitance	Ciss	VGS=0V, VDS=25V, f = 1MHz	-	2590	-	pF
Output capacitance	Coss		-	270	-	
Reverse transfer capacitance	Crss		-	50	-	
Turn on delay time	td(on)	VDD=0.5BVDSS, ID=15.0A (MOSFET switching time are essentially independent of operating temperature)	-	50	-	nS
Rise time	tr		-	155	-	
Turn off delay time	td(off)		-	270	-	
Fall time	tf		-	125	-	
Total gate charge (gate-source+gate-drain)	Qg	VGS=10V, ID=15.0A, VDS=0.5BVDSS(MOSFET Switching time are Essentially independent of Operating temperature)	-	90	-	nC
Gate-source charge	Qgs		-	15	-	
Gate-drain (Miller) charge	Qgd		-	45	-	

Note:

(1) Pulse Test : Pulse width 300uS, Duty Cycle 2 %

(2) $S = \frac{1}{R}$

Electrical Characteristics (CONTROL Part)

(VCC=16V, Tamb = 25 C unless otherwise specified)

Parameter	Symbol	Conditions	Min.	Typ.	Max.	Unit
UVLO SECTION						
Start Threshold Voltage	VSTART	VFB=GND	14	15	16	V
Stop Threshold Voltage	VSTOP	VFB=GND	8	9	10	V
OSCILLATOR SECTION						
Initial Frequency	FOSC	-	22	25	28	kHz
Voltage Stability	FSTABLE	12V VCC 23V	0		3	%
Temperature Stability (Note2)	FOSC	-25 C a 85 C	0	5	10	%
Maximum Duty Cycle	DMAX	-	92	95	98	%
Minimum Duty Cycle	DMIN	-	-	-	0	%
FEEDBACK SECTION						
Feedback Source Current	IFB	VFB=GND	0.7	0.9	1.1	mA
Shutdown Feedback Voltage	VSD	VFB 6.9V	6.9	7.5	8.1	V
Shutdown Delay Current	IDELAY	VFB=5V	1.6	2.0	2.4	A
SYNC. & SOFTSTART SECTION						
Softstart Voltage	VSS	VFB=2V	4.7	5.0	5.3	V
Softstart Current	ISS	VSS=0V	0.8	1.0	1.2	mA
Sync High Threshold Voltage(Note3)	VSYNCH	VCC=16V , VFB=5V	-	7.2	-	V
Sync Low Threshold Voltage(Note3)	VSYNCL	VCC=16V , VFB=5V	-	5.8	-	V
BURST MODE SECTION						
Burst Mode Low Threshold Voltage	VBURL	VFB=0V	10.4	11.0	11.6	V
Burst Mode High Threshold Voltage	VBURH	VFB=0V	11.4	12.0	12.6	V
Burst Mode Enable Feedback Voltage	VBEN	VCC=10.5V	0.7	1.0	1.3	V
Burst Mode Peak Current Limit(Note4)	IBURPK	VCC=10.5V , VFB=0V	0.6	0.85	1.1	A
Burst Mode Frequency	FBUR	VCC=10.5V , VFB=0V	40	50	60	kHz
CURRENT LIMIT(SELF-PROTECTION)SECTION						
Peak Current Limit (Note4)	IOVER	FS6S0965R	5.28	6.0	6.72	A
		FS6S1265R	7.04	8.0	8.96	
		FS6S15658R	7.04	8.0	8.96	
PROTECTION SECTION						
Over Voltage Protction	VOVP	VCC 27V	27	30	33	V
Over Current Latch voltage(Note3)	VOCL	-	0.9	1.0	1.1	V
Thermal Shutdown Temperature(Note2)	TSD	-	140	160	-	C
TOTAL DEVICE SECTION						
Start Up Current	ISTART	VFB=GND, VCC=14V	-	0.1	0.17	mA
Operating Supply Current(Note1)	IOP	VFB=GND, VCC=16V	-	10	15	mA
	IOP(MIN)	VFB=GND, VCC=12V				
	IOP(MAX)	VFB=GND, VCC=30V				

Note:

1. These parameters is the Current Flowing in the Control IC.
2. These parameters, although guaranteed, are not 100% tested in production
3. These parameters, although guaranteed, are tested in EDS(wafer test) process
4. These parameters are indicated Inductor Current.

Typical Performance Characteristics

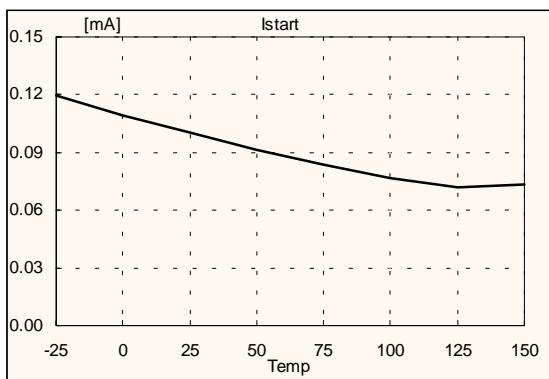

Figure 1. Start Up Current vs. Temp.

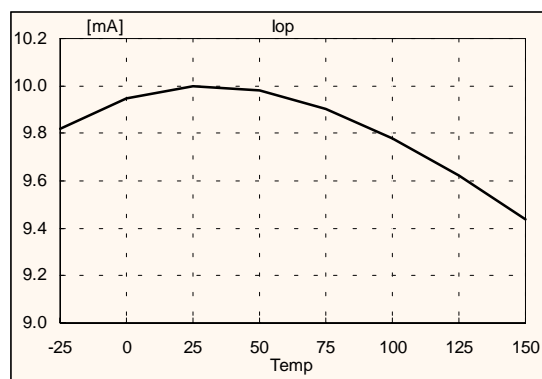

Figure 2. Operating Supply Current vs. Temp.

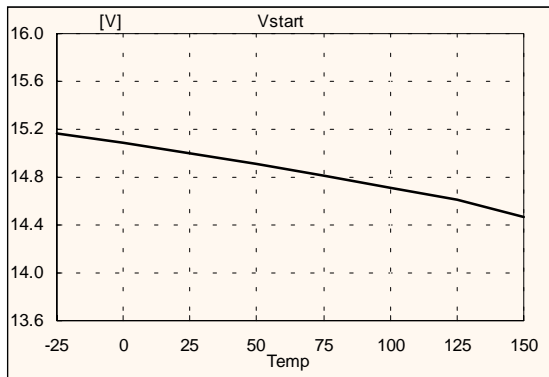

Figure 3. Start Threshold Voltage vs. Temp.

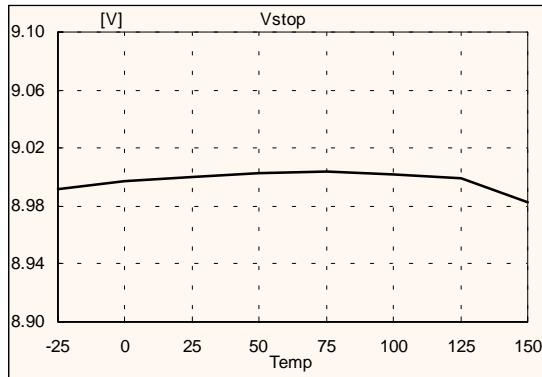

Figure 4. Stop Threshold Voltage vs. Temp.

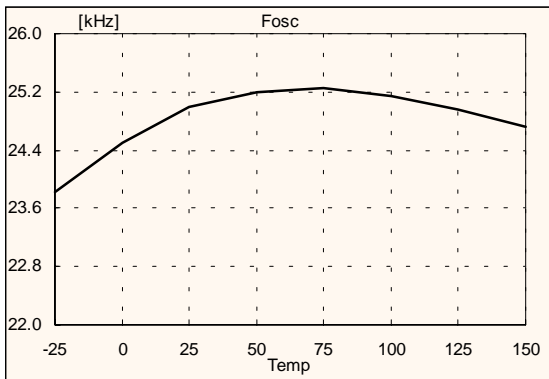

Figure 5. Initial Frequency vs. Temp.

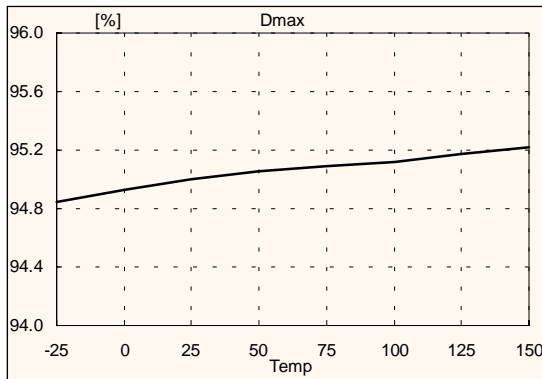

Figure 6. Maximum Duty vs. Temp.

Typical Performance Characteristics (Continued)

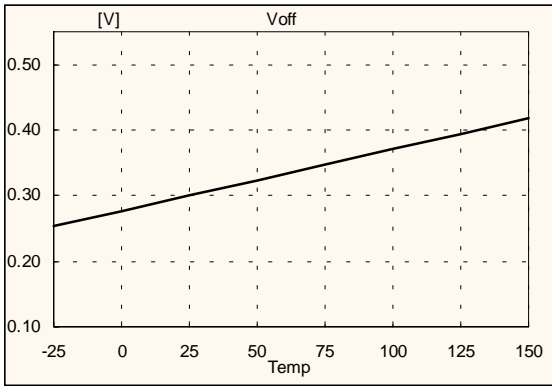

Figure 7. Feedback Offset Voltage vs. Temp.

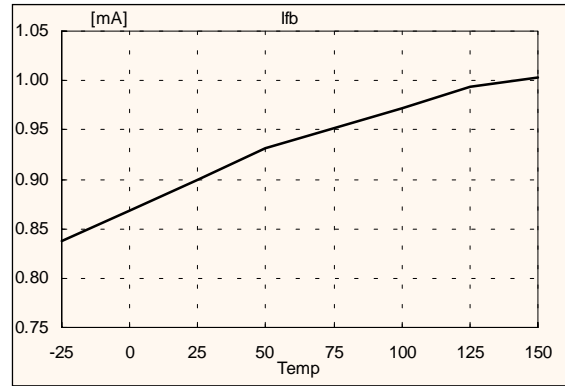

Figure 8. Feedback Source Current vs. Temp.

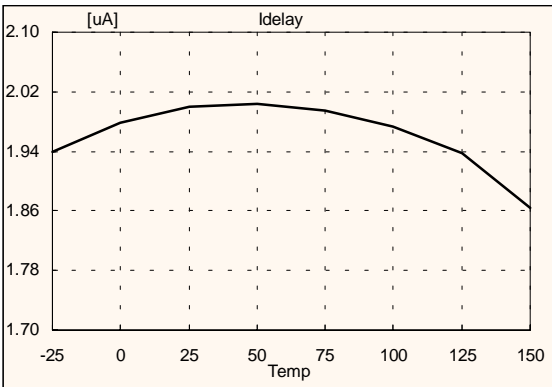

Figure 9. Shutdown Delay Current vs. Temp.

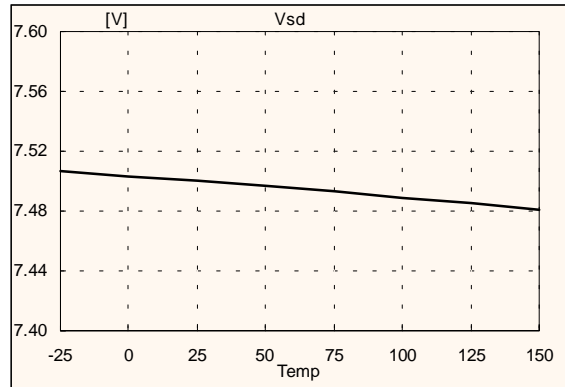

Figure 10. Shutdown Feedback Voltage vs. Temp.

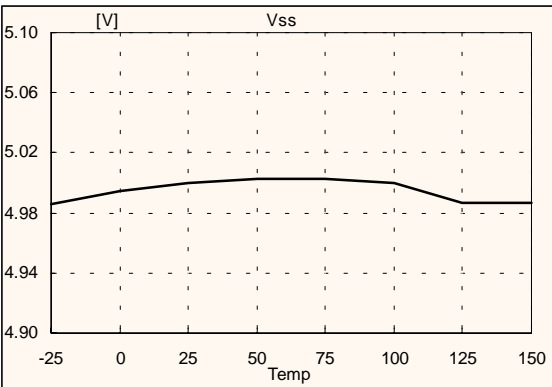

Figure 11. Softstart Voltage vs. Temp.

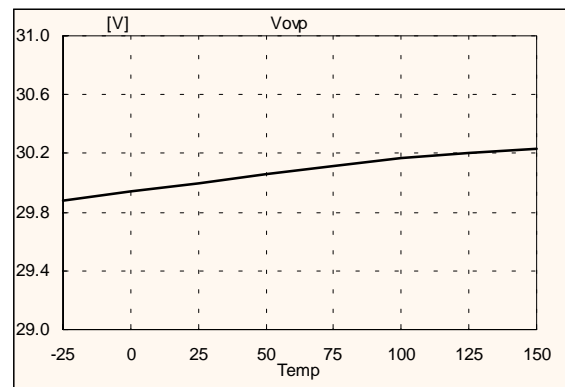

Figure 12. Over Voltage Protection vs. Temp.

Typical Performance Characteristics (Continued)

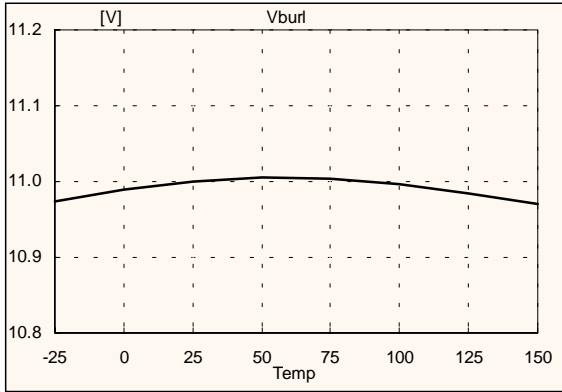

Figure 13. Burst Mode Low Voltage vs. Temp.

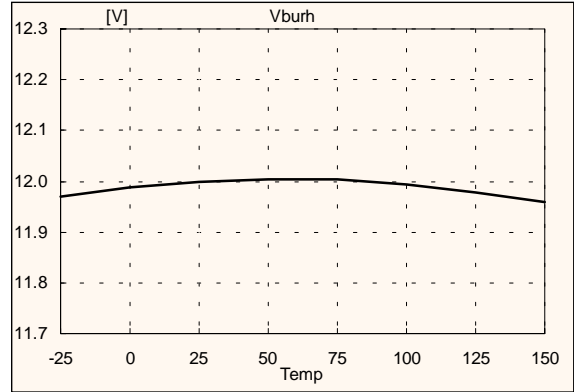

Figure 14. Burst Mode High Voltage vs. Temp.

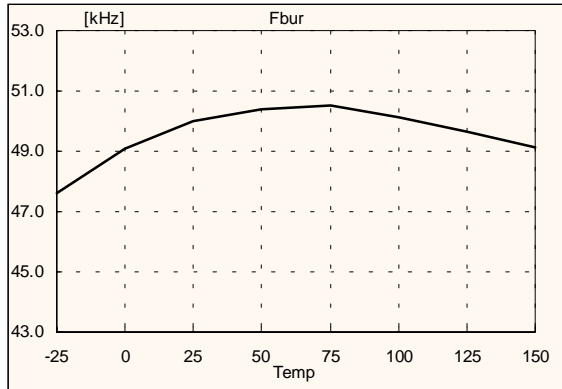

Figure 15. Burst Mode Frequency vs. Temp.

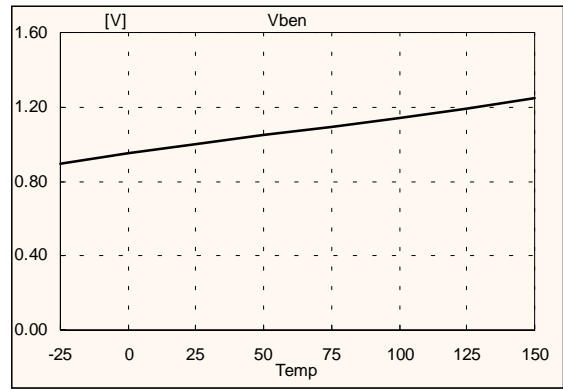

Figure 16. Burst Mode Enable Voltage vs. Temp.

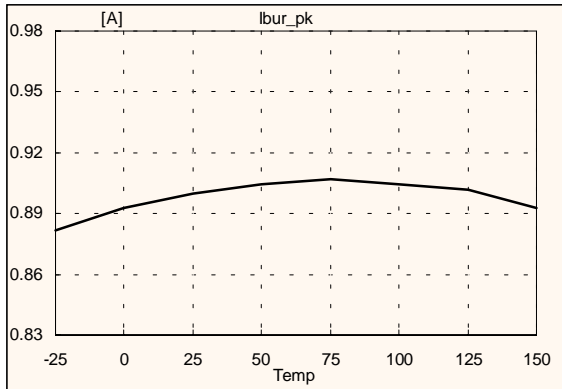

Figure 17. Burst Mode Peak Current vs. Temp.

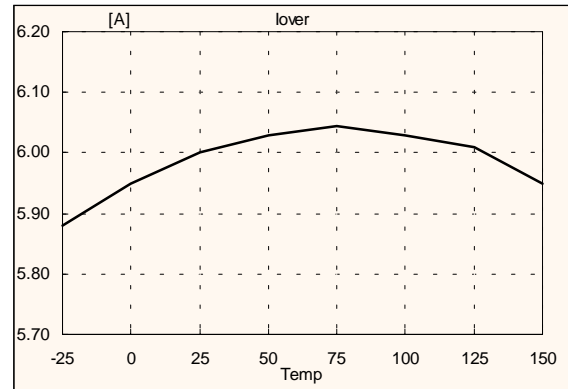

Figure 18. Peak Current Limit vs. Temp.

Package Dimensions

TO-3P-5L

Package Dimensions (Continued)

TO-3P-5L (Forming)

Package Dimensions (Continued)

TO-220F-5L

Package Dimensions (Continued)

TO-220F-5L (Forming)

TOP Mark and Pinout Information

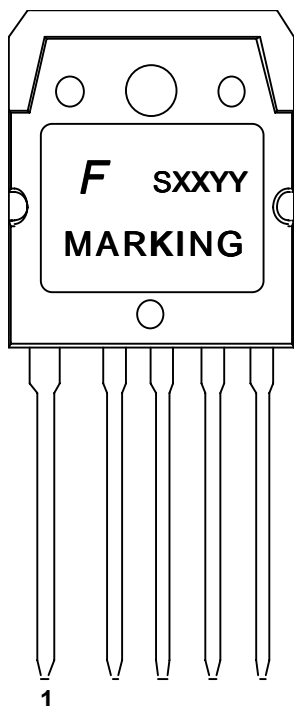

Pin No.	Symbol	Description
1	Drain	SenseFET Drain
2	GND	Ground (Source)
3	VCC	Control Part Supply Input
4	F/B	PWM Non Inverting Input
5	S/S	Soft start & External Sync.

Device	MARKING
FS6S0965R	6S0965R
FS6S0965RT	
FS6S1265R	6S1265R
FS6S15658R	6S15658R

Notes ;

- (1) F ; Fairchild Semiconductor
- (2) 6S0965R, 6S1265R, 6S15658R ; Device Marking Name
- (3) S: Plant Code (SPS: S)
- (4) XX: Patweek Based on Fairchild Semiconductor Work Month Calendar
- (5) YY: Last Two Digit of Calendar Year

Ordering Information

Product Number	Package	Marking Code	BVdss	Rds(on)
FS6S0965R-TU	TO-3P-5L	6S0965R	650V	1.1
FS6S0965R-YDTU	TO-3P-5L(Forming)			
FS6S0965RT-TU	TO-220F-5L	6S0965R	650V	1.1
FS6S0965RT-YDTU	TO-220F-5L(Forming)			
FS6S1265R-TU	TO-3P-5L	6S1265R	650V	0.7
FS6S1265R-YDTU	TO-3P-5L(Forming)			
FS6S15658R-TU	TO-3P-5L	6S15658R	650V	0.5
FS6S15658R-YDTU	TO-3P-5L(Forming)			

TU : Non Forming Type

YDTU : Forming Type

DISCLAIMER

LIFE SUPPORT POLICY

FAIRCHILD'S PRODUCTS ARE NOT AUTHORIZED FOR USE AS CRITICAL COMPONENTS IN LIFE SUPPORT DEVICES OR SYSTEMS WITHOUT THE EXPRESS WRITTEN APPROVAL OF THE PRESIDENT OF FAIRCHILD SEMICONDUCTOR CORPORATION. As used herein:

1. Life support devices or systems are devices or systems which, (a) are intended for surgical implant into the body, or (b) support or sustain life, and (c) whose failure to perform when properly used in accordance with instructions for use provided in the labeling, can be reasonably expected to result in a significant injury of the user.
2. A critical component in any component of a life support device or system whose failure to perform can be reasonably expected to cause the failure of the life support device or system, or to affect its safety or effectiveness.