

FAN7080_GF085 Half Bridge Gate Driver

Features

- Automotive qualified to AEC Q100
- Floating channel designed for bootstrap operation up to + 600V
- Tolerance to negative transient voltage on VS pin
- Common mode dv/dt noise cancelling circuit.
- Gate drive supply range from 5.5V to 20V
- Under-voltage lockout
- CMOS Schmitt-triggered inputs with pull-down
- High side output in phase with input
- 3.3V, 5V and 15V logic compatible input
- Matched propagation delay for both channels
- Adjustable dead time
- 8-Lead Small Outline Package (SO 8L NB)

Typical Applications

- Automotive DC-DC Converters
- Half and full bridge motor control applications



For Fairchild's definition of "green" Eco Status, please visit:
http://www.fairchildsemi.com/company/green/rohs_green.html

Description

The FAN7080_GF085 is a half-bridge gate drive IC with reset input and adjustable dead time control. It is designed for high voltage and high speed driving of MOSFET or IGBT, which operate up to 600V. Fairchild's high-voltage process and common-mode noise cancellation technique provide stable operation in the high side driver under high-dV/dt noise circumstances. An advanced level-shift circuit allows high-side gate driver operation up to VS=-5V (typical) at VBS=15V. Logic input is compatible with standard CMOS outputs. The UVLO circuits for both channels prevent malfunction when VCC and VBS are lower than the specified threshold voltage. Combined pin function for dead time adjustment and reset shutdown enable this IC to be packaged in a space saving SO 8L NB Package. Minimum source and sink current capability of output driver is 250mA and 500mA respectively, which is suitable for automotive DC-DC converters and half and full bridge motor control applications.

SO 8L NB

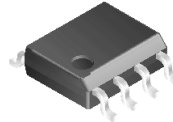

Ordering Information

Device	Package	Operating Temp.
FAN7080M_GF085	SO 8L NB	-40 °C ~ 125 °C
FAN7080MX_GF085	SO 8L NB	-40 °C ~ 125 °C

X : Tape & Reel type

Block Diagrams

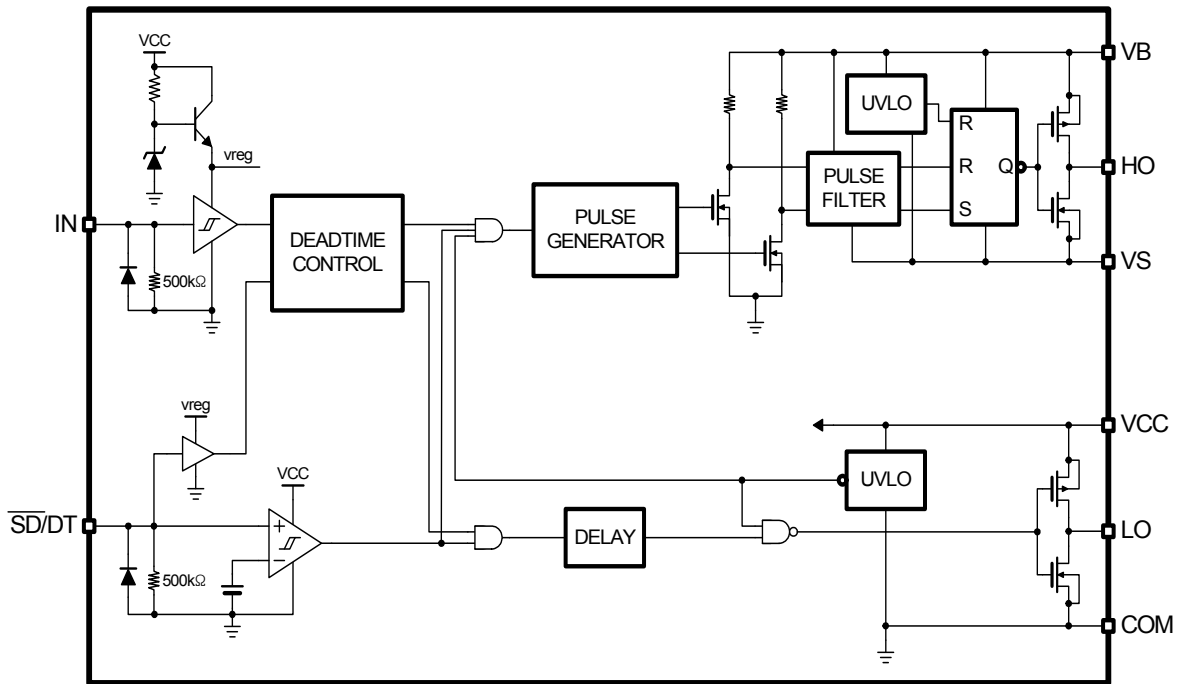

Pin Assignments

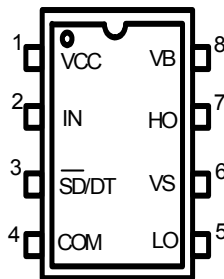

Pin Definitions

Pin Number	Pin Name	I/O	Pin Function Description
1	VCC	P	Driver supply voltage
2	IN	I	Logic input for high and low side gate drive output
3	SD/DT	I	Shut down input and dead time setting
4	COM	P	Ground
5	LO	A	Low side gate drive output for MOSFET Gate connection
6	VS	A	High side floating offset for MOSFET Source connection
7	HO	A	High side drive output for MOSFET Gate connection
8	VB	P	Driver output stage supply

Absolute Maximum Ratings

Absolute Maximum Ratings indicate sustained limits beyond which damage to the device may occur. All voltage parameters are absolute voltages referenced to COM.

Parameter	Symbol	Min.	Max.	Unit
High side floating supply offset voltage	VS	VB-25	VB+0.3	V
High side floating supply voltage	VB	-0.3	625	V
High side floating output voltage	VHO	Vs-0.3	VB+0.3	V
Low side output voltage	VLO	-0.3	VCC + 0.3	V
Supply voltage	VCC	-0.3	25	V
Input voltage for $\overline{\text{IN}}$	VIN	-0.3	VCC+0.3	V
Input injection current. Full function, no latch up:(Guaranteed by design). Test at 10V and 17V on Eng.Samples	IIN	-	+1	mA
Power Dissipation	Pd ⁽¹⁾		0.625	W
Thermal resistance, junction to ambient	Rthja ⁽¹⁾		200	°C/W
Electrostatic discharge voltage (Human Body Model)	V _{ESD}	1K		V
Charge device model	V _{CDM}	500		V
Junction Temperature	T _J		150	°C
Storage Temperature	T _S	-55	150	°C

Note: 1) The thermal resistance and power dissipation rating are measured bellow conditions;

JESD51-2: Integrated Circuit Thermal Test Method Environmental Conditions - Natural convection(StillAir)

JESD51-3 : Low Effective Thermal Conductivity Test Board for Leaded Surface Mount Package

Recommended Operating Conditions

For proper operation the device should be used within the recommended conditions.

Parameter	Symbol	Min.	Max.	Unit
High side floating supply voltage(DC) Transient:-10V@ 0.1 us	VB ⁽¹⁾	Vs + 6	Vs + 20	V
High side floating supply offset voltage(DC) Transient: -25V(max) @0.1us @VBS<25V	VS	-5	600	V
High side floating output voltage	VHO	Vs	VB	V
Low side output voltage	VLO	0	VCC	V
Allowable offset voltage Slew Rate ⁽²⁾	dv/dt	-	50	V/ns
Supply voltage for logic part	VCC	5.5	20	V
Logic input voltage	VIN	0	Vcc	V
Switching Frequency ⁽³⁾	Fs		200	KHz
Ambient Temperature	Ta	-40	125	°C

Note: 1) The Vs offset is tested with all supplies biased at 15V differential.

2) Guaranteed by design.

3) When VDT= 1.2V.

Statics Electrical Characteristics

Unless otherwise specified, $-40^{\circ}\text{C} \leq T_a \leq 125^{\circ}\text{C}$, $V_{CC} = 15\text{V}$, $V_{BS} = 15\text{V}$, $V_S = 0\text{V}$, $C_L = 1\text{nF}$.

Parameter	Symbol	Conditions	Min.	Typ.	Max.	Unit
Vcc and VBS supply Characteristics						
VCC and VBS supply under voltage positive going threshold	VCCUV+ VBSUV+	-	-	4.2	5.5	V
VCC and VBS supply under voltage negative going threshold	VCCUV- VBSUV-	-	2.8	3.6	-	V
VCC and VBS supply under voltage hysteresis	VCCUVH VBSUVH	-	0.2	0.6	-	V
Under voltage lockout response time	tduvcc tduvbs	VCC: 6V-->2.5V or 2.5V-->6V VBS: 6V-->2.5V or 2.5V-->6V	0.5 0.5	- -	20 20	us us
Offset supply leakage current	ILK	VB=VS=600V	-	20	50	uA
Quiescent VBS supply current	IQBS	VIN=0 OR 5V, VSDT = 1.2V	20	75	150	uA
Quiescent Vcc supply current	IQCC	VIN=0 OR 5, VSDT = 1.2V	-	350	1000	uA
Input Characteristics						
High logic level input voltage	VIH		2.7	-	-	V
Low logic level input voltage	VIL		-	-	0.8	V
High logic level input bias current for IN	IIN+	VIN=5V	-	10	50	uA
Low logic level input bias current for IN	IIN-	VIN=0V	-	0	2	uA
VSDT dead time setting range	VDT		1.2	-	5	V
VSDT shutdown threshold voltage	VSD		-	0.8	1.2	V
High logic level resistance for $\overline{\text{SD}}/\text{DT}$	RSDT	VSDT=5V	100	500	1100	K Ω
Low logic level input bias current for $\overline{\text{SD}}/\text{DT}$	ISDT-	VSDT=0V	-	1	2	uA
Output characteristics						
High level output voltage, VCC-VHO	VOH(HO)	IO=0	-	-	0.1	V
Low level output voltage, VHO	VOL(HO)	IO=0	-	-	0.1	V
Output high short circuit pulse current	IO+(HO)		250	300	-	mA
Output low short circuit pulse current	IO-(HO)		500	600	-	mA
Equivalent output resistance	ROP(HO)		-	-	60	Ω
	RON(HO)		-	-	30	Ω
High level output voltage, VB-VLO	VOH(LO)	IO=0	-	-	0.1	V
Low level output voltage, VLO	VOL(LO)	IO=0	-	-	0.1	V
Output high short circuit pulse current	IO+(LO)		250	-	-	mA
Output low short circuit pulse current	IO-(LO)		500	-	-	mA
Equivalent output resistance	ROP(LO)		-	-	60	Ω
	RON(LO)		-	-	30	Ω

Dynamic Electrical Characteristics

Unless otherwise specified, $-40^{\circ}\text{C} \leq T_a \leq 125^{\circ}\text{C}$, $V_{CC} = 15\text{V}$, $V_{BS} = 15\text{V}$, $V_S = 0\text{V}$, $C_L = 1\text{nF}$.

Parameter	Symbol	Conditions	Min.	Typ.	Max.	Unit
Turn-on propagation delay	t_{on}	$V_S=0\text{V}$	-	750	1500	ns
Turn-off propagation delay	t_{off}	$V_S=0\text{V}$	-	130	250	ns
Turn -on rising time	t_r	-	-	40	150	ns
Turn -off falling time	t_f	-	-	25	400	ns
Dead time, LS turn-off to HS turn-on and HS turn-on to LS turn-off	DT	$V_{IN}=0$ or $5\text{V}@ V_{DT}=1.2\text{V}$ $V_{IN}=0$ or $5\text{V}@ V_{DT}=3.3\text{V}$	250 1600	650 2100	1200 2600	ns
Dead time matching time	MDT	$DT_1 - DT_2@ V_{DT}=1.2\text{V}$ $DT_1 - DT_2@ V_{DT}=3.3\text{V}$	-	35 -	110 300	ns
Delay Matching, HS and LS turn-on	MTON	$V_{DT}=1.2\text{V}$	-	25	110	ns
Delay Matching, HS and LS turn-off	MTOFF	$V_{DT}=1.2\text{V}$	-	15	60	ns
Shutdown propagation delay	T_{sd}		-	180	330	ns
Switching Frequency	F_{s1}	$V_{CC}=V_{BS}=20\text{V}$	-	-	200	KHz
	F_{s2}	$V_{CC}=V_{BS}=5.5\text{V}$	-	-	200	KHz

Typical Application Circuit

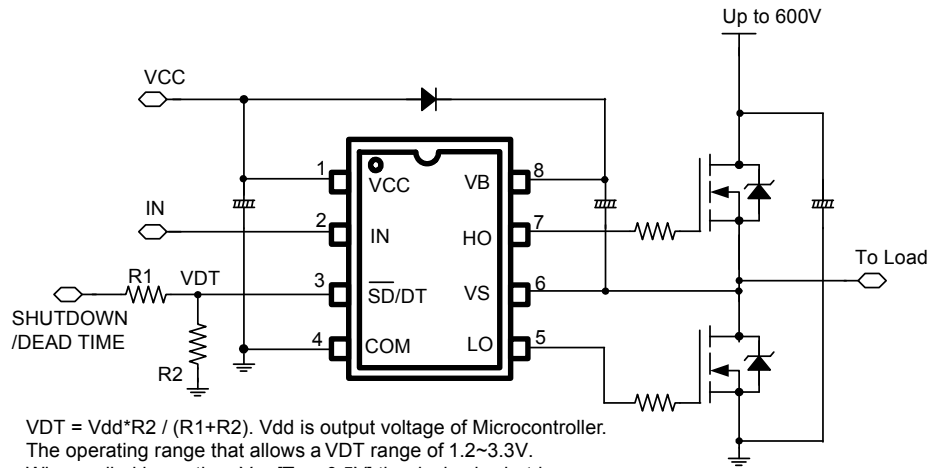

$VDT = V_{dd} \cdot R2 / (R1 + R2)$. V_{dd} is output voltage of Microcontroller.
 The operating range that allows a VDT range of 1.2~3.3V.
 When pulled lower than V_{DT} [Typ. 0.5V] the device is shutdown.
 Care must be taken to avoid Voltage spikes below the shutdown threshold on pin 3 that can cause undesired shut down of the IC. For this reason the connection of the components between pin3 and ground has to be as short as possible. And a capacitor (Typ 0.02uF)between pin3 and COM can prevent this spike. This pin can not be left floating for the same reason.

Typical Waveforms

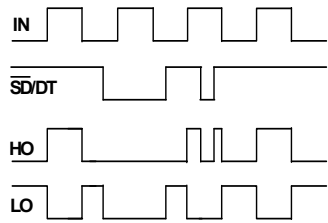

Figure 1. Input/output Timing Diagram

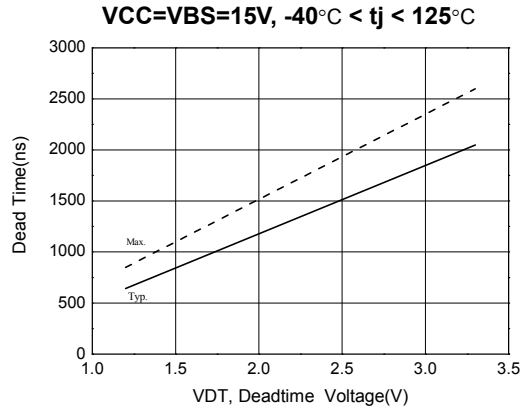

Figure 2. Dead Time VS VDT

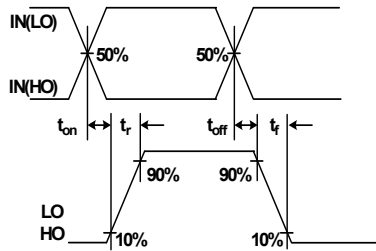

Figure 3. Switching Time Waveform Definitions

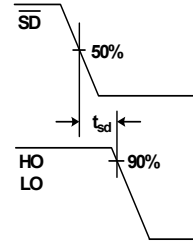

Figure 4. Shutdown Waveform Definitions

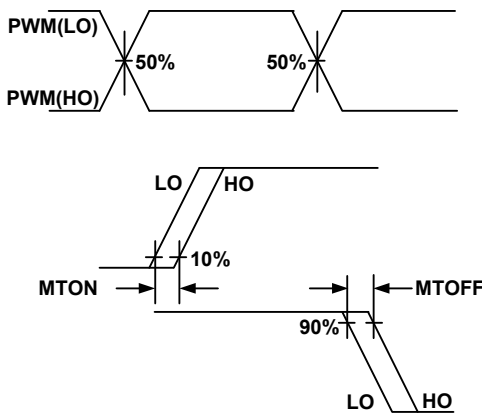

Figure 5. Delay Matching Waveform Definitions

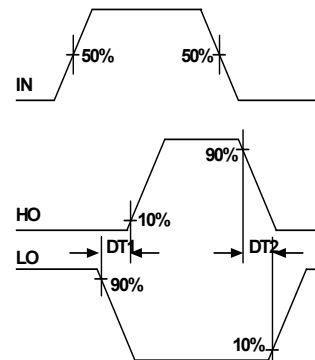

Figure 6. Dead Time Waveform Definitions

Performance Graphs (This performance graphs based on ambient temperature -40°C ~125°C)

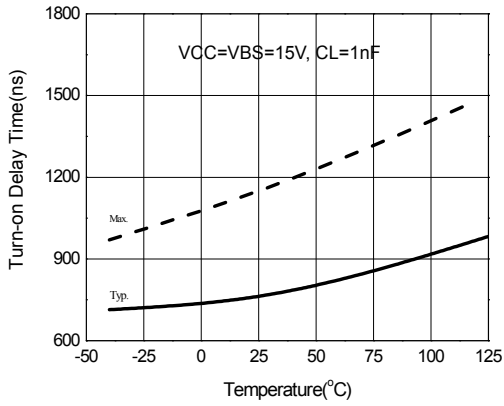

Figure 7a. Turn-On Delay Time of HO vs VBS Temperature

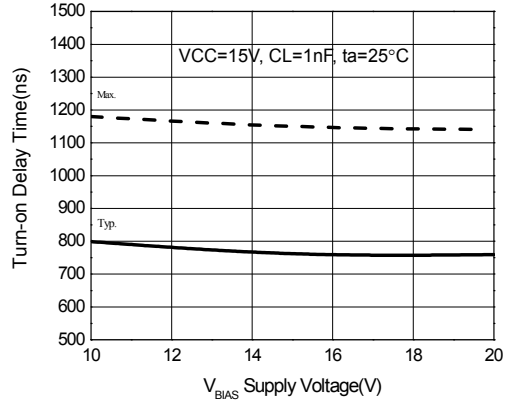

Figure 7b. Turn-On Delay Time of HO vs VBS Supply Voltage

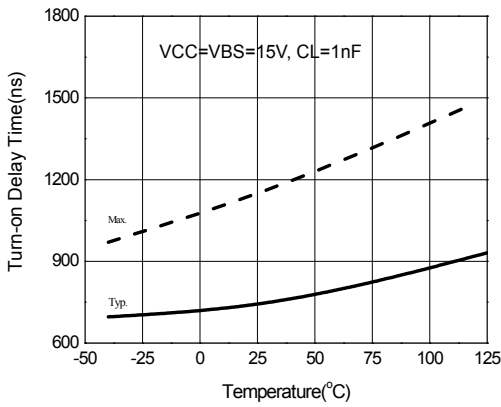

Figure 8a. Turn-On Delay Time of LO vs Temperature

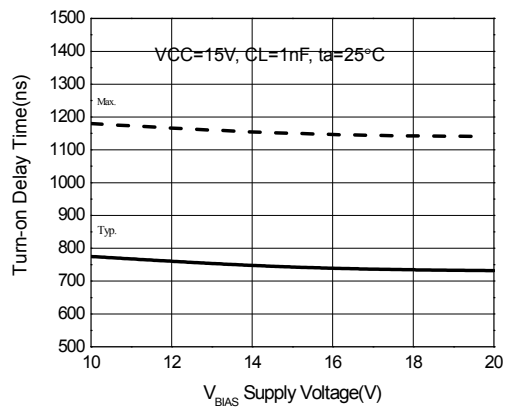

Figure 8b. Turn-On Delay Time vs of LO VBS Supply Voltage

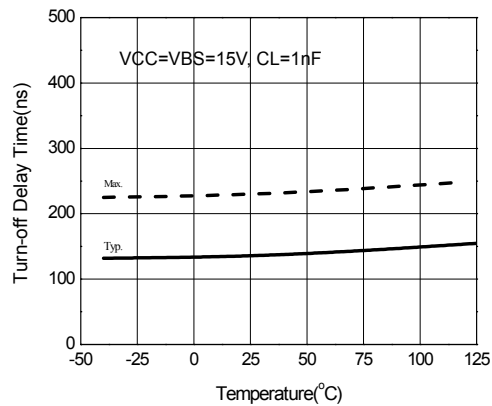

Figure 9a. Turn-Off Delay Time of HO vs Temperature

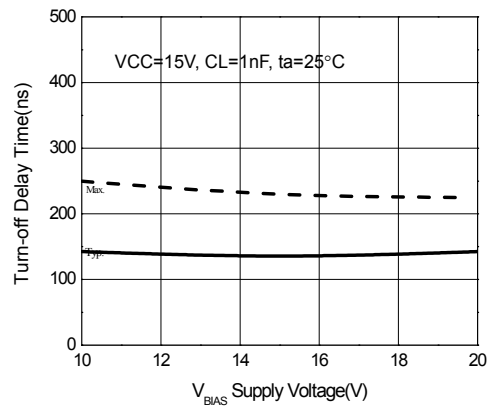

Figure 9b. Turn-Off Delay Time of HO vs VBS Supply Voltage

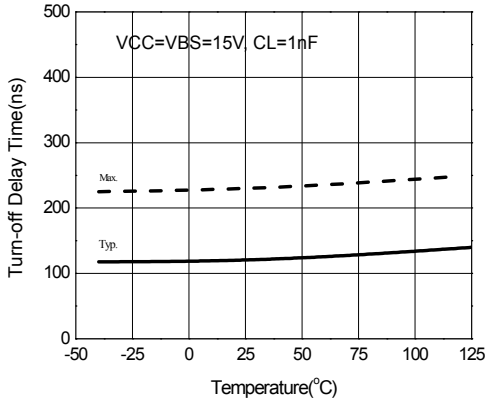

Figure 10a. Turn-Off Delay Time of LO vs Temperature

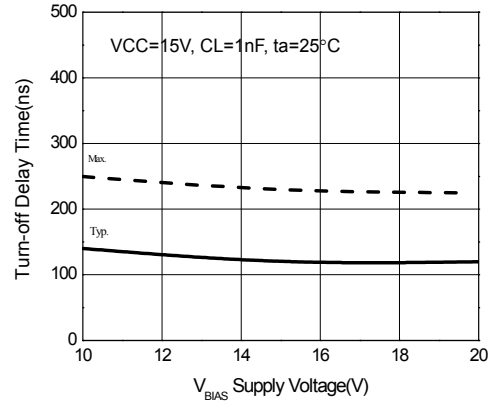

Figure 10b. Turn-Off Delay Time of LO vs VBS Supply Voltage

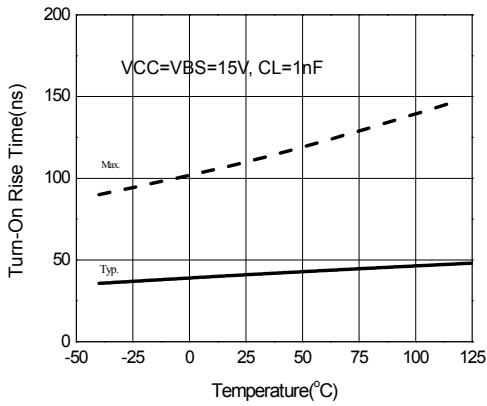

Figure 11a. Turn-On Rise Time of HO vs Temperature

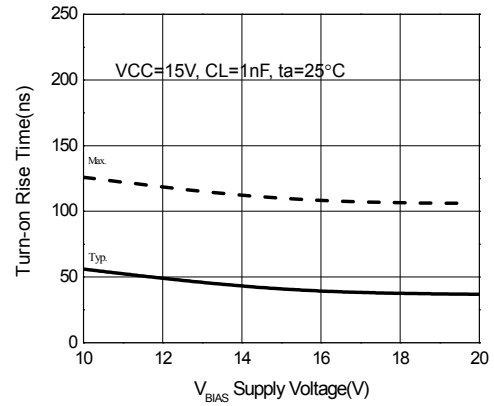

Figure 11b. Turn-On Rise Time vs of HO VBS Supply Voltage

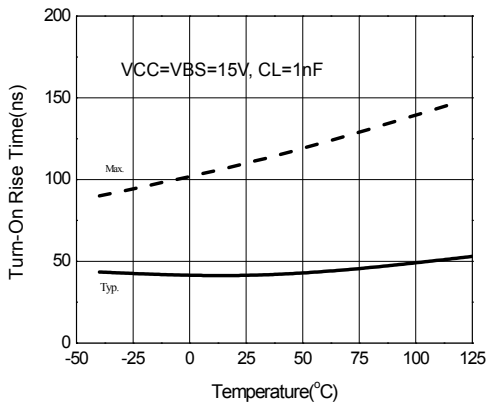

Figure 12a. Turn-On Rise Time of LO vs Temperature

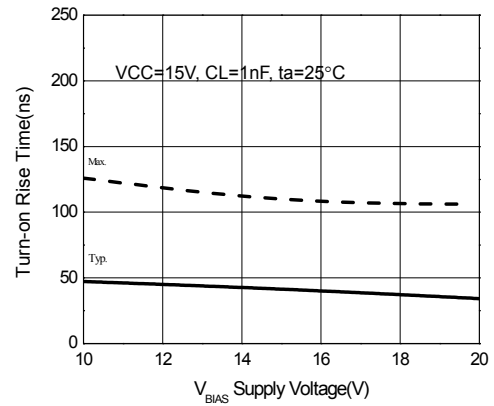

Figure 12b. Turn-On Rise Time of LO vs VBS Supply Voltage

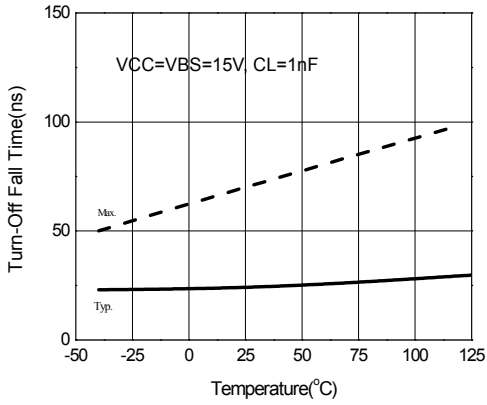

Figure 13a. Turn-Off Fall Time of HO vs Temperature

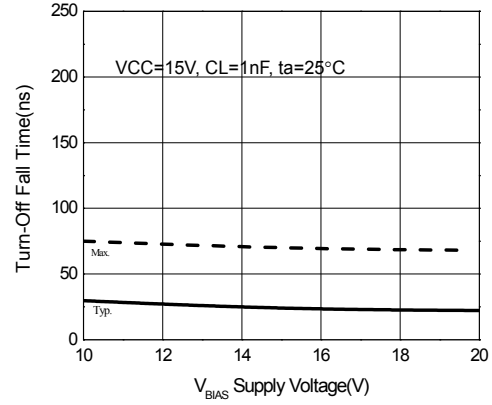

Figure 13b. Turn-Off Fall Time of HO vs VBS Supply Voltage

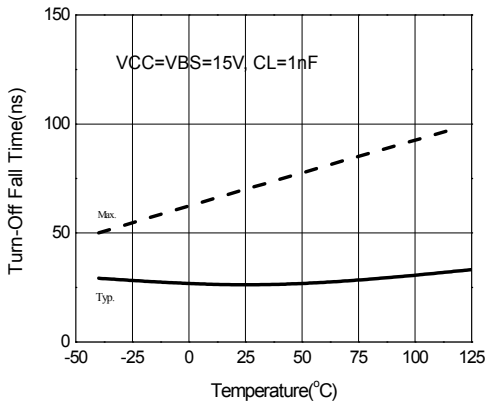

Figure 14a. Turn-Off Fall Time of LO vs Temperature

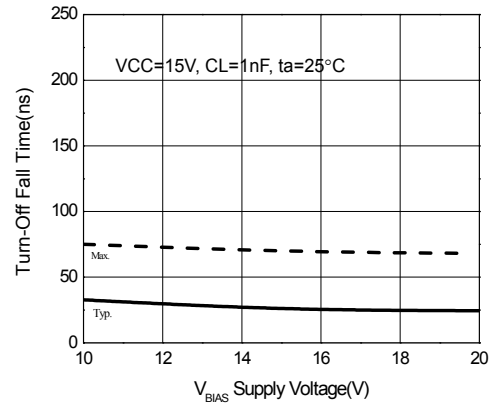

Figure 14b. Turn-Off Fall Time of LO vs BS Supply Voltage

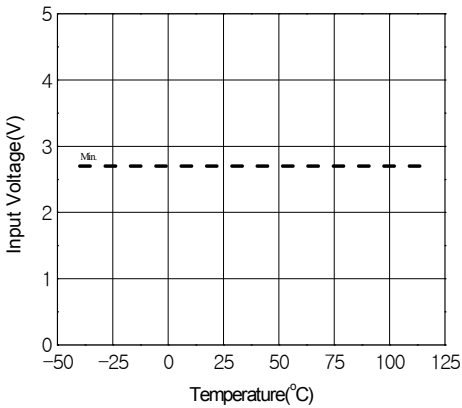

Figure 15a. Logic 0 Input Voltage vs Temperature

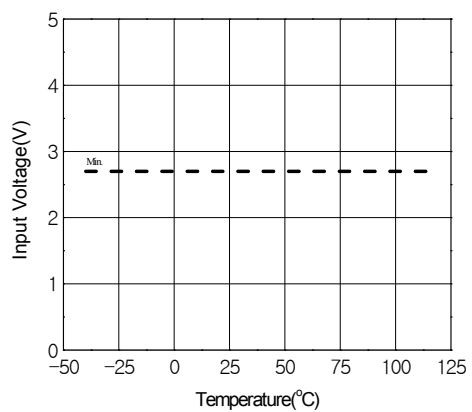

Figure 15b. Logic 1 Input Voltage vs Temperature

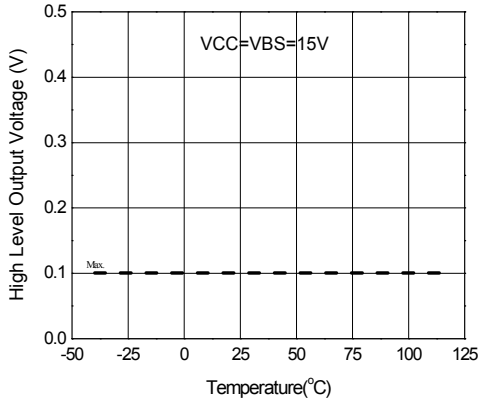

Figure 16a. High Level Output of HO vs Temperature

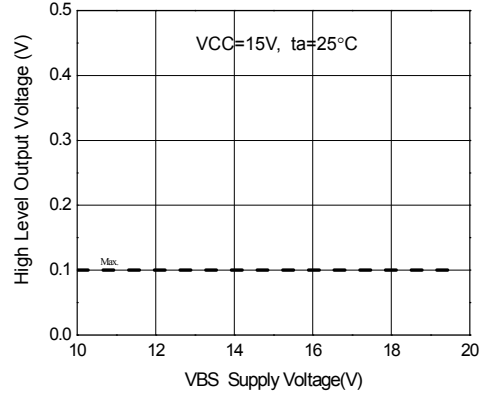

Figure 16b. High Level Output of HO vs VBS Supply Voltage

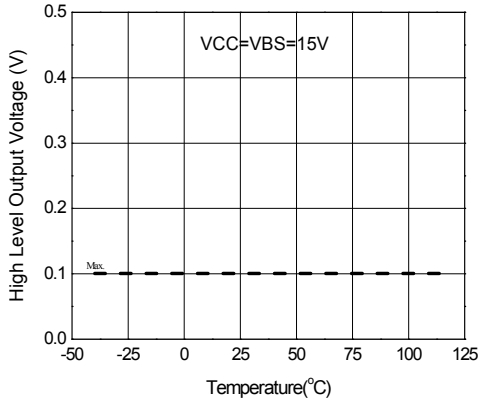

Figure 17a. High Level Output of LO vs Temperature

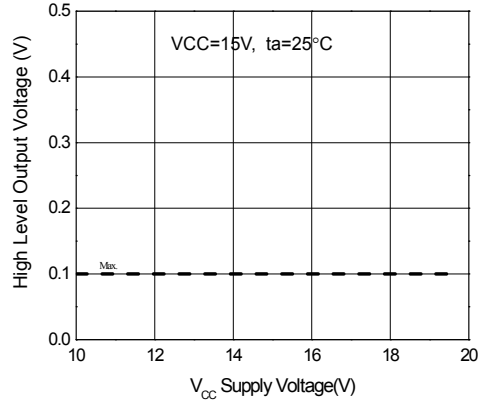

Figure 17b. High Level Output of LO vs VCC Supply Voltage

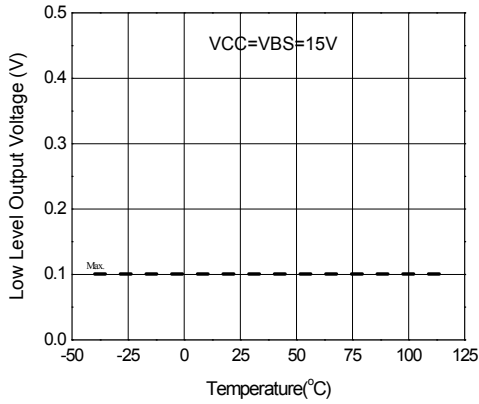

Figure 18a. Low Level Output of HO vs Temperature

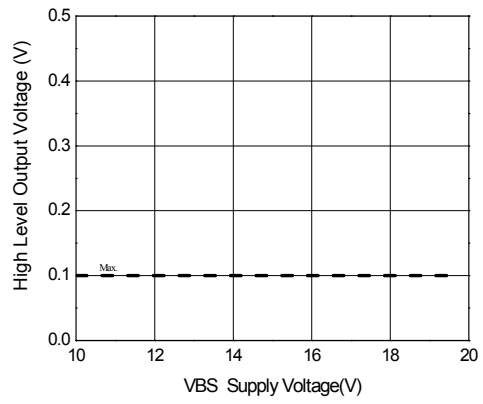

Figure 18b. Low Level Output of HO vs VBS Supply Voltage

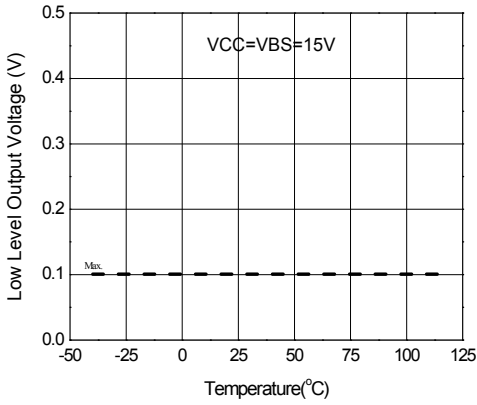

Figure 19a. Low Level Output of LO vs Temperature

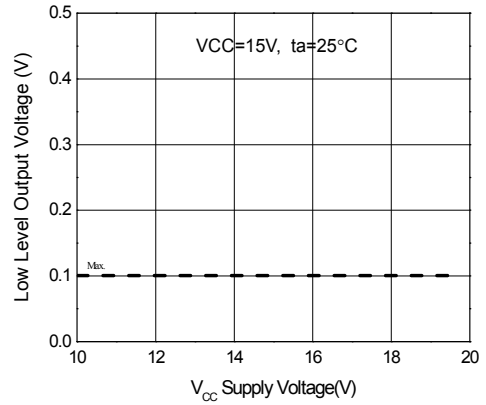

Figure 19b. Low Level Output of LO vs VCC Supply Voltage

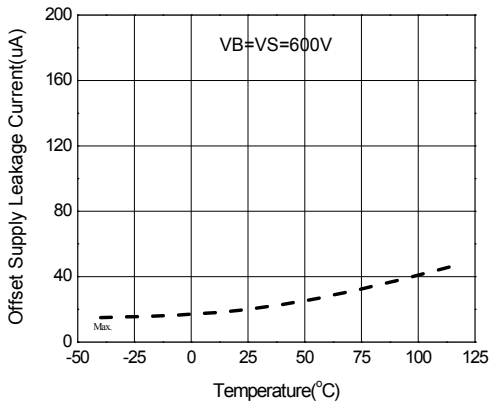

Figure 20a. Offset Supply leakage Current vs Temperature

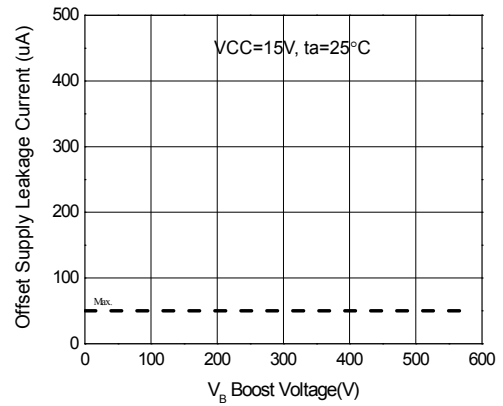

Figure 20b. Offset Supply leakage Current vs VB Boost Voltage

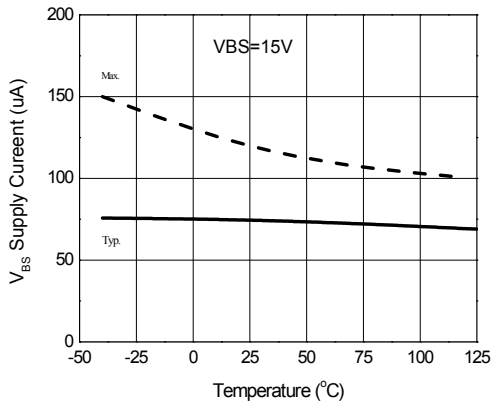

Figure 21. VBS Supply Current vs Temperature

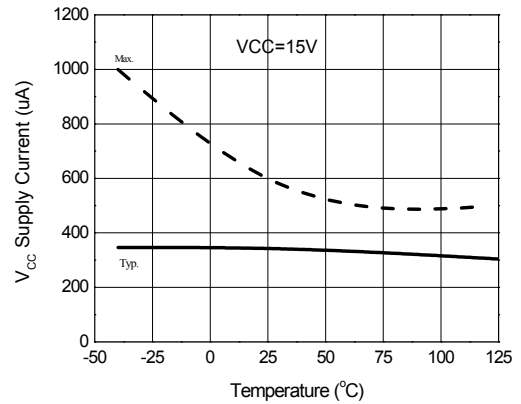

Figure 22. VCC Supply Current vs Temperature

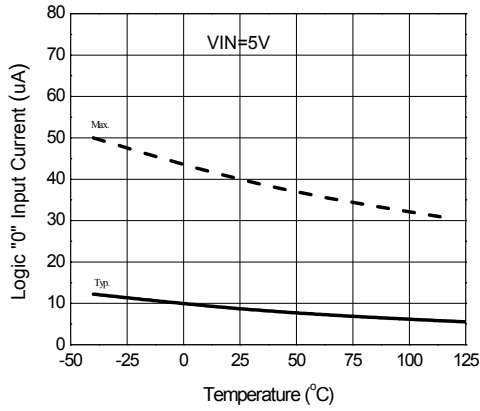

Figure 23a. Logic 1 Input Current vs Temperature

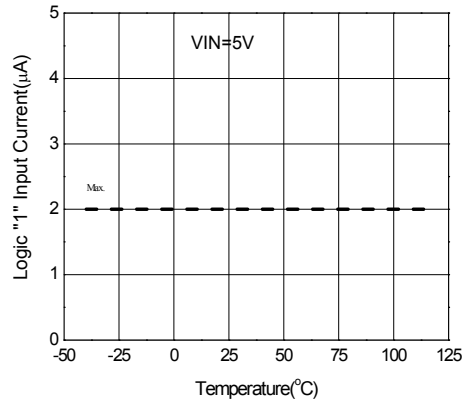

Figure 23b. Logic 0 Input Current vs Temperature

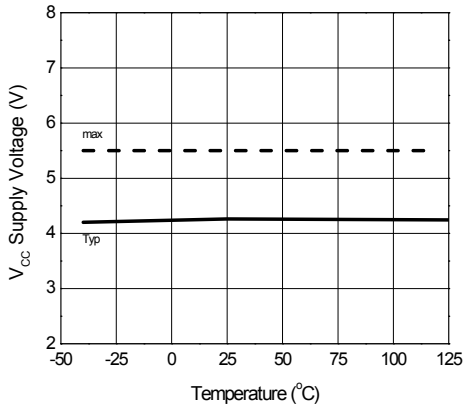

Figure 24a. VCC UnderVoltage Threshold (+) vs Temperature

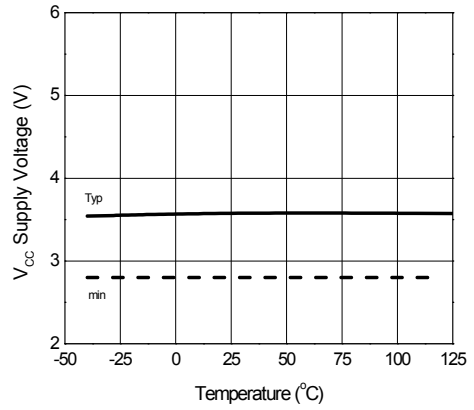

Figure 24b. VCC UnderVoltage Threshold(-) vs Temperature

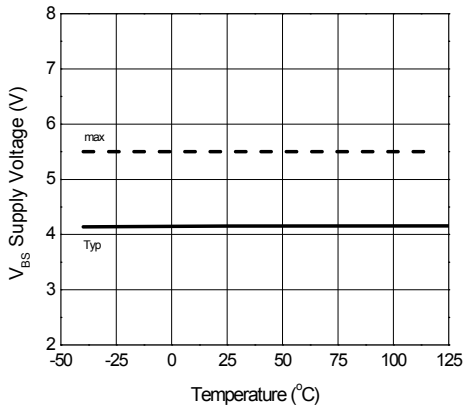

Figure 25a. VBS UnderVoltage Threshold (+) vs Temperature

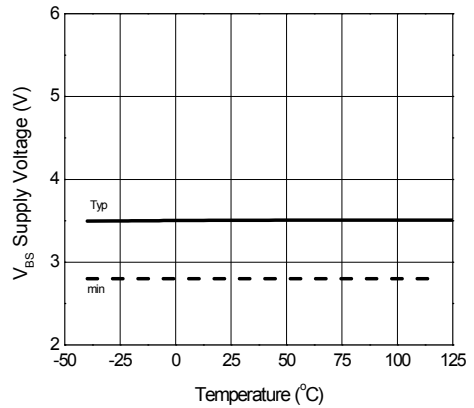

Figure 25b. VBS UnderVoltage Threshold(-) vs Temperature

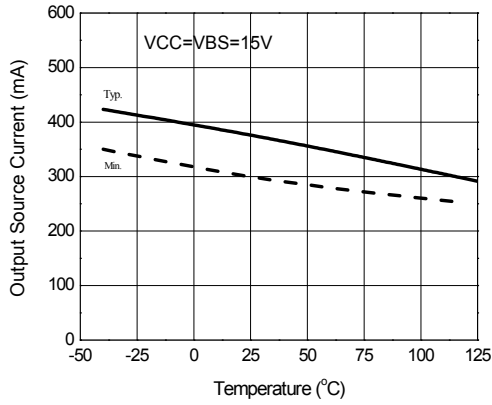

Figure 26a. Output Source Current of HO vs Temperature

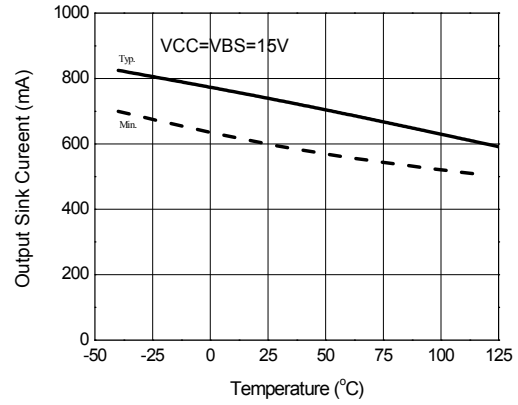

Figure 26b. Output Sink Current of HO vs Temperature

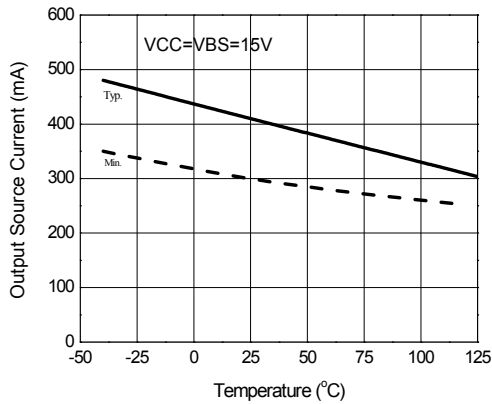

Figure 27a. Output Source Current of LO vs Temperature

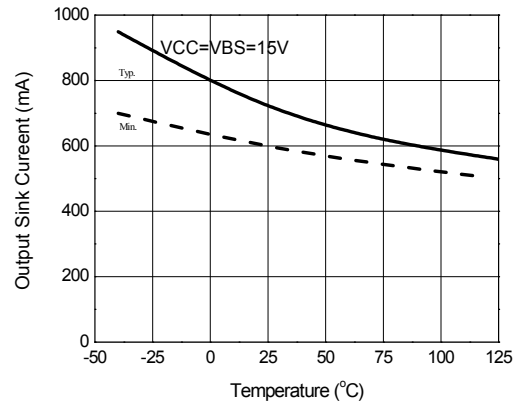

Figure 27b. Output Sink Current of LO vs Temperature

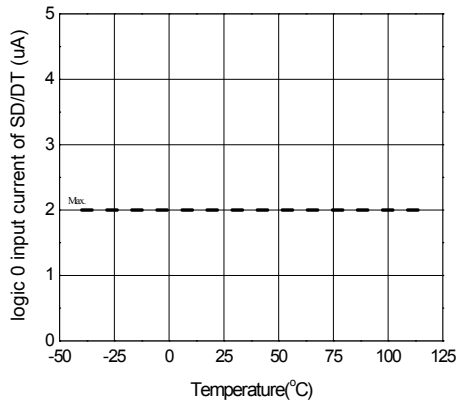

Figure 28. Logic 0 Input Current of SD/DT vs Temperature

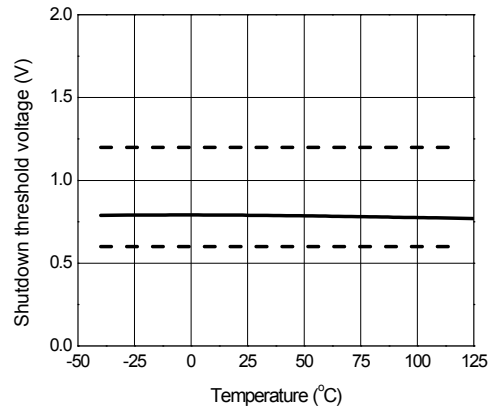

Figure 29. Shutdown Threshold of vs Temperature

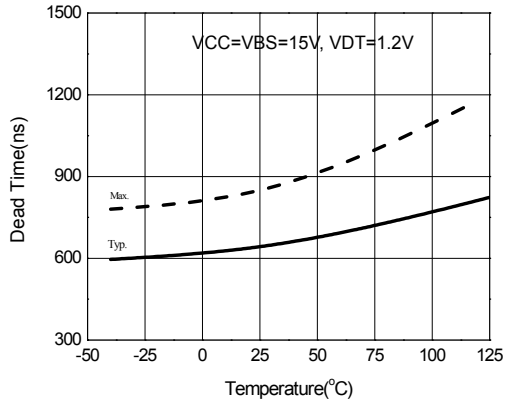

Figure 30. Deadtime vs Temperature

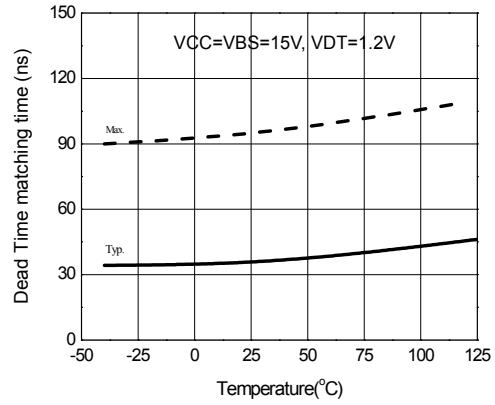

Figure 31. Deadtime Matching Time vs Temperature

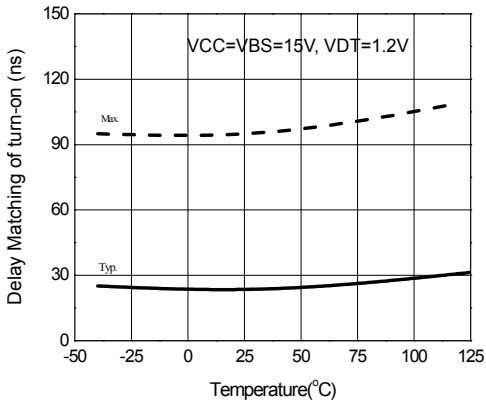

Figure 32. Turn-On Delay Matching vs Temperature

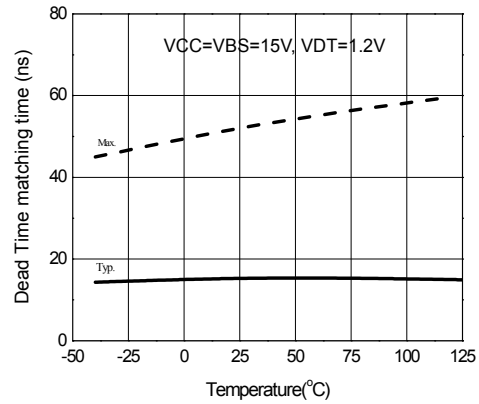

Figure 33. Turn_Off Delay Matching vs Temperature

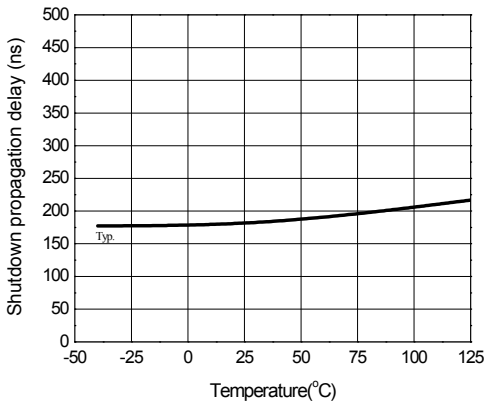

Figure 34. Shutdown Propagation Delay vs Temperature

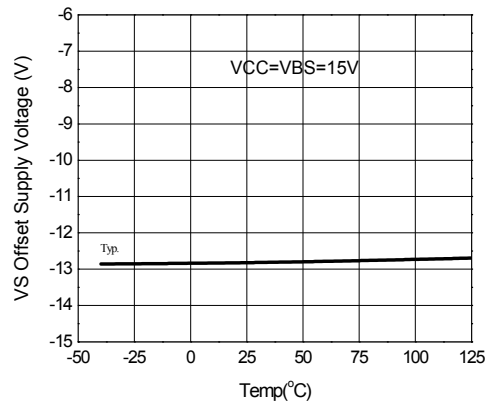
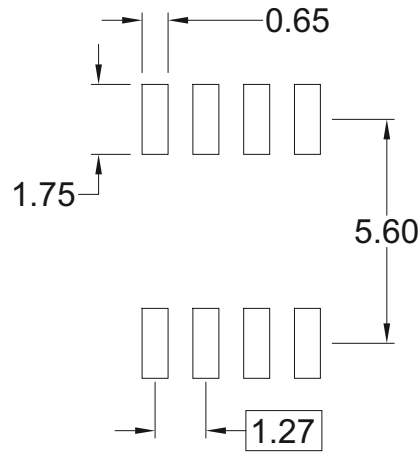
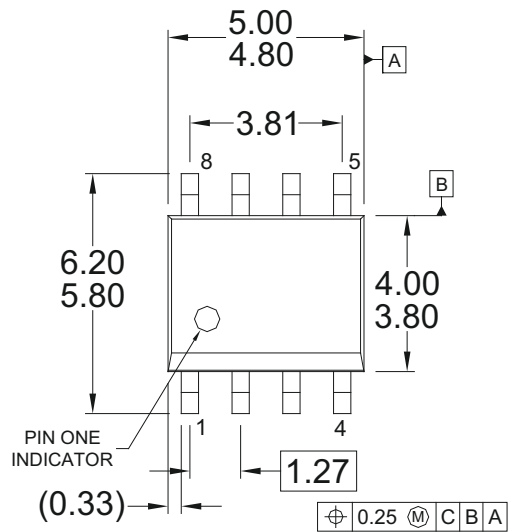
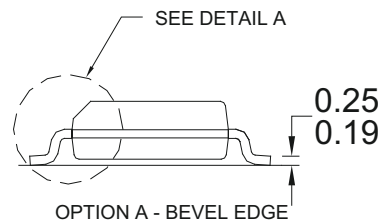
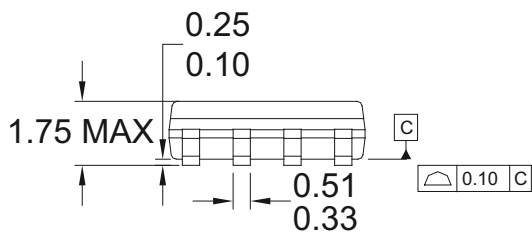

Figure 35. Maximum VS Negative Offset of vs Temperature

Package Dimensions



LAND PATTERN RECOMMENDATION



OPTION A - BEVEL EDGE

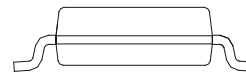

OPTION B - NO BEVEL EDGE

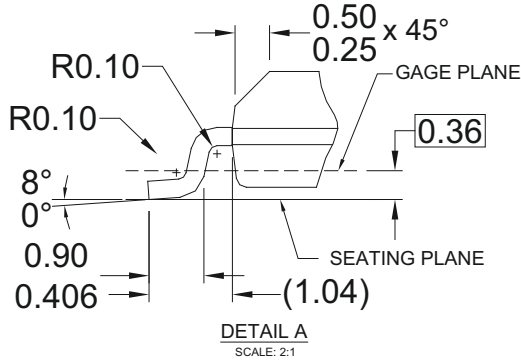

DETAIL A
SCALE: 2:1

NOTES: UNLESS OTHERWISE SPECIFIED

- A) THIS PACKAGE CONFORMS TO JEDEC MS-012, VARIATION AA, ISSUE C,
- B) ALL DIMENSIONS ARE IN MILLIMETERS.
- C) DIMENSIONS DO NOT INCLUDE MOLD FLASH OR BURRS.
- D) LANDPATTERN STANDARD: SOIC127P600X175-8M.
- E) DRAWING FILENAME: M08AREV13







Package drawings are provided as a service to customers considering Fairchild components. Drawings may change in any manner without notice. Please note the revision and/or date on the drawing and contact a Fairchild Semiconductor representative to verify or obtain the most recent revision. Package specifications do not expand the terms of Fairchild's worldwide terms and conditions, specifically the warranty therein, which covers Fairchild products.

Always visit Fairchild Semiconductor's online packaging area for the most recent package drawings:
<http://www.fairchildsemi.com/packaging/>



TRADEMARKS

The following includes registered and unregistered trademarks and service marks, owned by Fairchild Semiconductor and/or its global subsidiaries, and is not intended to be an exhaustive list of all such trademarks.

AccuPower™	FlashWriter®*	Power-SPM™	 SYSTEM GENERAL The Power Franchise®  the power Franchise TinyBoost™ TinyBuck™ TinyCalc™ TinyLogic® TINYOPTO™ TinyPower™ TinyPWM™ TinyWire™ TriFault Detect™ TRUECURRENT™* μSerDes™  SerDes UHC® Ultra FRFET™ UniFET™ VCX™ VisualMax™ XS™
Auto-SPM™	FPS™	PowerTrench®	
Build it Now™	F-PFS™	PowerXS™	
CorePLUS™	FRFET®	Programmable Active Droop™	
CorePOWER™	Global Power Resource SM	QFET®	
CROSSVOLT™	Green FPS™	QS™	
CTL™	Green FPS™ e-Series™	Quiet Series™	
Current Transfer Logic™	Gmax™	RapidConfigure™	
EcoSPARK®	GTO™	 ™	
EfficientMax™	IntelliMAX™	Saving our world, 1mW/W/kW at a time™	
EZSWITCH™*	ISOPLANAR™	SignalWise™	
 ™*	MegaBuck™	SmartMax™	
DEUXPEED™	MICROCOUPLER™	SMART START™	
 ™	MicroFET™	SPM®	
Fairchild®	MicroPak™	STEALTH™	
Fairchild Semiconductor®	MillerDrive™	SuperFET™	
FACT Quiet Series™	MotionMax™	SuperSOT™-3	
FACT®	Motion-SPM™	SuperSOT™-6	
FAST®	OPTOLOGIC®	SuperSOT™-8	
FAST®	OPTOPLANAR®	SupreMOS™	
FastvCore™	 ™	SyncFET™	
FETBench™	PDP SPM™	Sync-Lock™	

* Trademarks of System General Corporation, used under license by Fairchild Semiconductor.

DISCLAIMER

FAIRCHILD SEMICONDUCTOR RESERVES THE RIGHT TO MAKE CHANGES WITHOUT FURTHER NOTICE TO ANY PRODUCTS HEREIN TO IMPROVE RELIABILITY, FUNCTION, OR DESIGN. FAIRCHILD DOES NOT ASSUME ANY LIABILITY ARISING OUT OF THE APPLICATION OR USE OF ANY PRODUCT OR CIRCUIT DESCRIBED HEREIN; NEITHER DOES IT CONVEY ANY LICENSE UNDER ITS PATENT RIGHTS, NOR THE RIGHTS OF OTHERS. THESE SPECIFICATIONS DO NOT EXPAND THE TERMS OF FAIRCHILD'S WORLDWIDE TERMS AND CONDITIONS, SPECIFICALLY THE WARRANTY THEREIN, WHICH COVERS THESE PRODUCTS.

LIFE SUPPORT POLICY

FAIRCHILD'S PRODUCTS ARE NOT AUTHORIZED FOR USE AS CRITICAL COMPONENTS IN LIFE SUPPORT DEVICES OR SYSTEMS WITHOUT THE EXPRESS WRITTEN APPROVAL OF FAIRCHILD SEMICONDUCTOR CORPORATION.

As used herein:

1. Life support devices or systems are devices or systems which, (a) are intended for surgical implant into the body or (b) support or sustain life, and (c) whose failure to perform when properly used in accordance with instructions for use provided in the labeling, can be reasonably expected to result in a significant injury of the user.
2. A critical component in any component of a life support, device, or system whose failure to perform can be reasonably expected to cause the failure of the life support device or system, or to affect its safety or effectiveness.

ANTI-COUNTERFEITING POLICY

Fairchild Semiconductor Corporation's Anti-Counterfeiting Policy. Fairchild's Anti-Counterfeiting Policy is also stated on our external website, www.fairchildsemi.com, under Sales Support.

Counterfeiting of semiconductor parts is a growing problem in the industry. All manufacturers of semiconductor products are experiencing counterfeiting of their parts. Customers who inadvertently purchase counterfeit parts experience many problems such as loss of brand reputation, substandard performance, failed applications, and increased cost of production and manufacturing delays. Fairchild is taking strong measures to protect ourselves and our customers from the proliferation of counterfeit parts. Fairchild strongly encourages customers to purchase Fairchild parts either directly from Fairchild or from Authorized Fairchild Distributors who are listed by country on our web page cited above. Products customers buy either from Fairchild directly or from Authorized Fairchild Distributors are genuine parts, have full traceability, meet Fairchild's quality standards for handling and storage and provide access to Fairchild's full range of up-to-date technical and product information. Fairchild and our Authorized Distributors will stand behind all warranties and will appropriately address any warranty issues that may arise. Fairchild will not provide any warranty coverage or other assistance for parts bought from Unauthorized Sources. Fairchild is committed to combat this global problem and encourage our customers to do their part in stopping this practice by buying direct or from authorized distributors.

PRODUCT STATUS DEFINITIONS

Definition of Terms

Datasheet Identification	Product Status	Definition
Advance Information	Formative / In Design	Datasheet contains the design specifications for product development. Specifications may change in any manner without notice.
Preliminary	First Production	Datasheet contains preliminary data; supplementary data will be published at a later date. Fairchild Semiconductor reserves the right to make changes at any time without notice to improve design.
No Identification Needed	Full Production	Datasheet contains final specifications. Fairchild Semiconductor reserves the right to make changes at any time without notice to improve the design.
Obsolete	Not In Production	Datasheet contains specifications on a product that is discontinued by Fairchild Semiconductor. The datasheet is for reference information only.

Rev. I43