

## DS7820/DS8820 Dual Line Receiver

### General Description

The DS7820, specified from  $-55^{\circ}\text{C}$  to  $+125^{\circ}\text{C}$ , and the DS8820, specified from  $0^{\circ}\text{C}$  to  $+70^{\circ}\text{C}$ , are digital line receivers with two completely independent units fabricated on a single silicon chip. Intended for use with digital systems connected by twisted pair lines, they have a differential input designed to reject large common mode signals while responding to small differential signals. The output is directly compatible with TTL or LS integrated circuits.

The response time can be controlled with an external capacitor to eliminate noise spikes, and the output state is determined for open inputs. Termination resistors for the twisted pair line are also included in the circuit. Both the DS7820 and the DS8820 are specified, worst case, over their full operating temperature range, for  $\pm 10$ -percent supply voltage variations and over the entire input voltage range.

### Features

- Operation from a single +5V logic supply
- Input voltage range of  $\pm 15\text{V}$
- Each channel can be strobed independently
- High input resistance
- Fan out of two with TTL integrated circuits
- Strobe low forces output to "1" state

### Connection Diagram

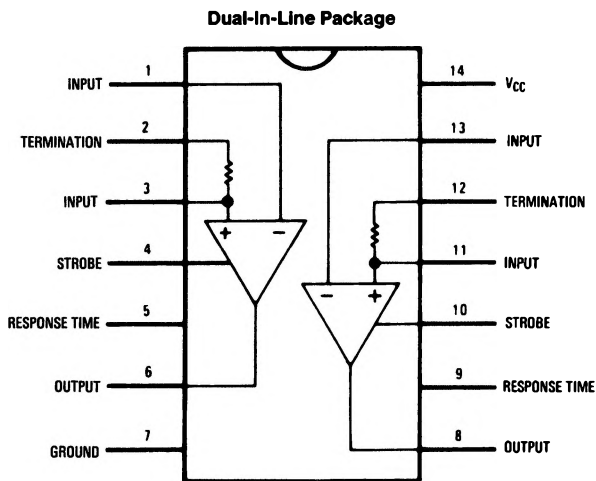

TL/F/5796-2

Top View

Order Number DS7820J or DS8820N  
See NS Package Number J14A or N14A

**For Complete Military 883 Specifications, See RETS Data Sheet.**  
Order Number: DS7820J/883 or DS7820W/883  
See NS Package Number J14A or W14B

**Absolute Maximum Ratings** (Note 1)

If Military/Aerospace specified devices are required, please contact the National Semiconductor Sales Office/Distributors for availability and specifications.

Supply Voltage	8.0V
Input Voltage	±20V
Differential Input Voltage	±20V
Strobe Voltage	8.0V
Output Sink Current	25 mA
Storage Temperature Range	-65°C to +150°C
Lead Temperature (Soldering, 4 sec.)	260°C

Maximum Power Dissipation\* at 25°C

Cavity Package	1308 mW
Molded Package	1207 mW

\*Derate cavity package 8.7 mW/°C above 25°C; derate molded package 9.7 mW/°C above 25°C.

**Operating Conditions**

	Min	Max	Units
Supply Voltage ( $V_{CC}$ )			
DS7820	4.5	5.5	V
DS8820	4.75	5.25	V
Temperature ( $T_A$ )			
DS7820	-55	+125	°C
DS8820	0	+70	°C

**Electrical Characteristics** (Notes 2 and 3)

Symbol	Parameter	Conditions	Min	Typ	Max	Units
$V_{TH}$	Input Threshold Voltage	$V_{CM} = 0V$	-0.5	0	0.5	V
		$-15V \leq V_{CM} \leq 15V$	-1.0	0	1.0	V
$V_{OH}$	High Output Level	$I_{OUT} \leq 0.2 \text{ mA}$	2.5		5.5	V
$V_{OL}$	Low Output Level	$I_{SINK} \leq 3.5 \text{ mA}$	0		0.4	V
$R_{I^-}$	Inverting Input Resistance		3.6	5.0		k $\Omega$
$R_{I^+}$	Non-Inverting Input Resistance		1.8	2.5		k $\Omega$
$R_T$	Line Termination Resistance	$T_A = 25^\circ\text{C}$	120	170	250	$\Omega$
$t_r$	Response Time	$C_{DELAY} = 0 \text{ pF}$		40		ns
		$C_{DELAY} = 100 \text{ pF}$		150		ns
$I_{ST}$	Strobe Current	$V_{STROBE} = 0.4V$		-1.0	-1.4	mA
		$V_{STROBE} = 5.5V$			5.0	$\mu\text{A}$
$I_{CC}$	Power Supply Current	$V_{IN} = 15V$		3.2	6.0	mA
		$V_{IN} = 0V$		5.8	10.2	mA
		$V_{IN} = -15V$		8.3	15.0	mA
$I_{IN^+}$	Non-Inverting Input Current	$V_{IN} = 15V$		5.0	7.0	mA
		$V_{IN} = 0V$	-1.6	-1.0		mA
		$V_{IN} = -15V$	-9.8	-7.0		mA
$I_{IN^-}$	Inverting Input Current	$V_{IN} = 15V$		3.0	4.2	mA
		$V_{IN} = 0V$		0	-0.5	mA
		$V_{IN} = -15V$	-4.2	-3.0		mA

**Note 1:** "Absolute Maximum Ratings" are those values beyond which the safety of the device cannot be guaranteed. Except for "Operating Temperature Range" they are not meant to imply that the devices should be operated at these limits. The table of "Electrical Characteristics" provides conditions for actual device operation.

**Note 2:** These specifications apply for  $4.5V \leq V_{CC} \leq 5.5V$ ,  $-15V \leq V_{CM} \leq 15V$  and  $-55^\circ\text{C} \leq T_A \leq +125^\circ\text{C}$  for the DS7820 or  $0^\circ\text{C} \leq T_A \leq +70^\circ\text{C}$  for the DS8820 unless otherwise specified; typical values given are for  $V_{CC} = 5.0V$ ,  $T_A = 25^\circ\text{C}$  and  $V_{CM} = 0$  unless stated differently.

**Note 3:** All currents into device pins shown as positive, out of device pins as negative, all voltages referenced to ground unless otherwise noted. All values shown as max or min on absolute value basis.

**Note 4:** The specifications and curves given are for one side only. Therefore, the total package dissipation and supply currents will be double the values given when both receivers are operated under identical conditions.

# Typical Performance Characteristics (Note 3)

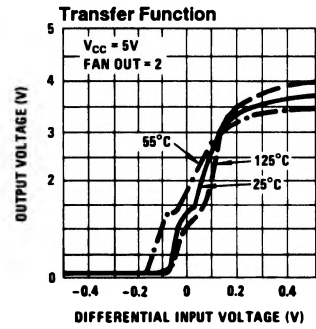
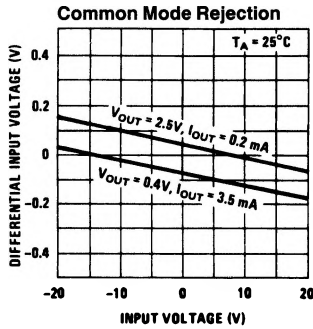
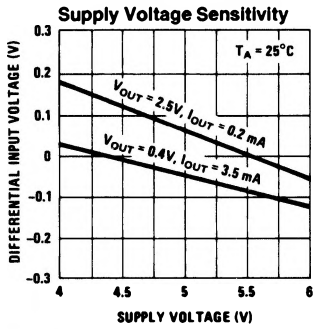

TL/F/5796-4

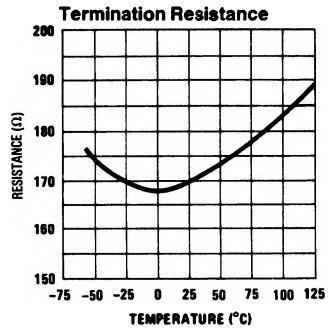
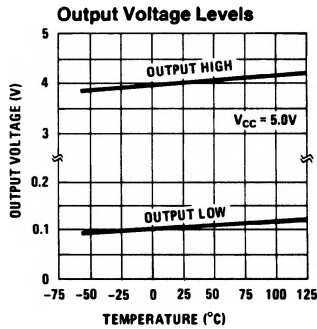
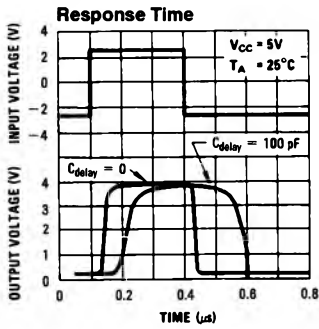

TL/F/5796-5

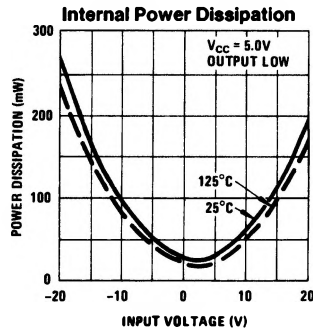
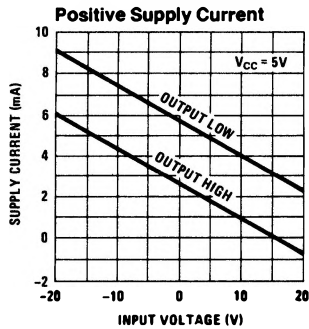

TL/F/5796-6

### Typical Application

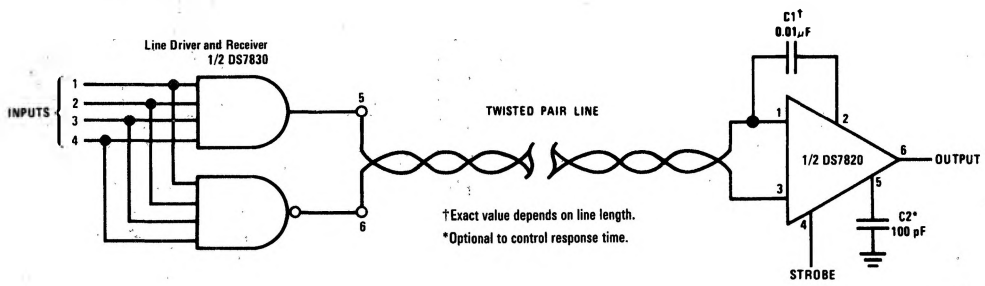

TL/F/5796-3

### Schematic Diagram

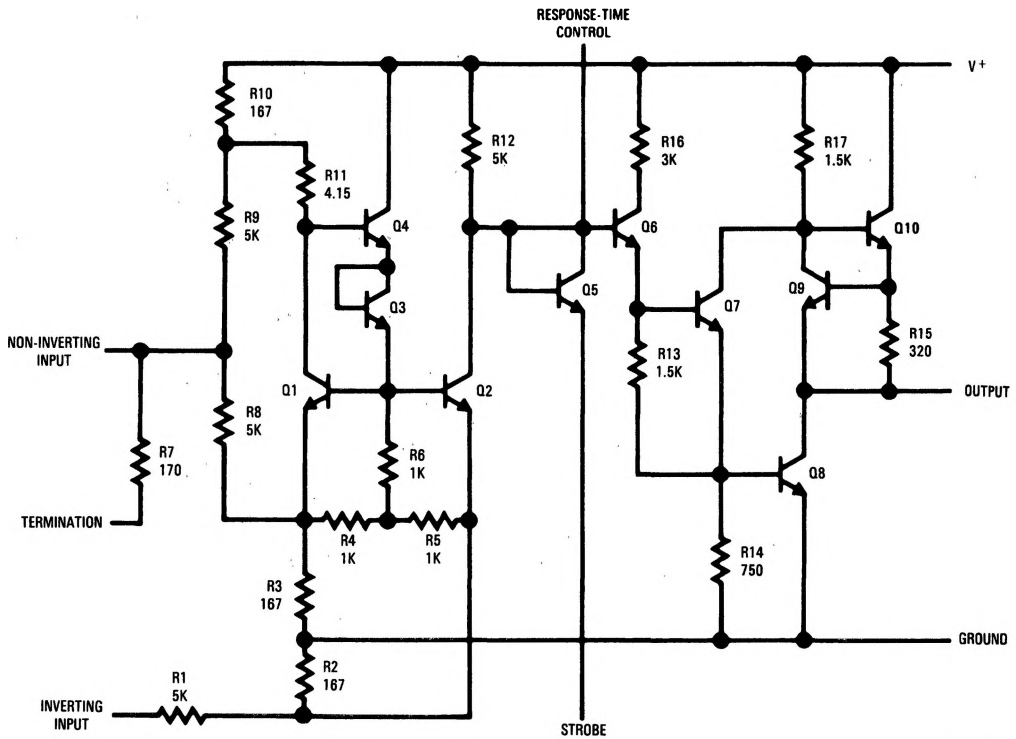

TL/F/5796-1