

# DS1631/DS3631/DS1632/DS3632/DS1633/DS3633/ DS1634/DS3634 CMOS Dual Peripheral Drivers

## General Description

The DS1631 series of dual peripheral drivers was designed to be a universal set of interface components for CMOS circuits.

Each circuit has CMOS compatible inputs with thresholds that track as a function of  $V_{CC}$  (approximately  $\frac{1}{2} V_{CC}$ ). The inputs are PNPs providing the high impedance necessary for interfacing with CMOS.

Outputs have high voltage capability, minimum breakdown voltage is 56V at 250  $\mu$ A.

The outputs are Darlington connected transistors. This allows high current operation (300 mA max) at low internal  $V_{CC}$  current levels since base drive for the output transistor is obtained from the load in proportion to the required loading conditions. This is essential in order to minimize loading on the CMOS logic supply.

Typical  $V_{CC} = 5V$  power is 28 mW with both outputs ON.  $V_{CC}$  operating range is 4.5V to 15V.

The circuit also features output transistor protection if the  $V_{CC}$  supply is lost by forcing the output into the high impedance OFF state with the same breakdown levels as when  $V_{CC}$  was applied.

Pin-outs are the same as the respective logic functions found in the following popular series of circuits: DS75451, DS75461. This feature allows direct conversion of present systems to the MM74C CMOS family and DS1631 series circuits with great power savings.

The DS1631 series is also TTL compatible at  $V_{CC} = 5V$ .

## Features

- CMOS compatible inputs
  - High impedance inputs
  - High output voltage breakdown
  - High output current capability
  - Same pin-outs and logic functions as DS75451 and DS75461 series circuits
  - Low  $V_{CC}$  power dissipation (28 mW both outputs "ON" at 5V)
- PNP's  
56V min  
300 mA max

## Connection Diagrams (Dual-In-Line and Metal Can Packages)

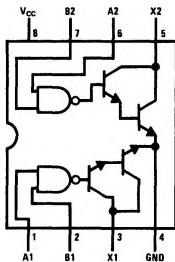

TL/F/5816-1

**Top View**  
Order Number **DS1631J-8**  
or **DS3631N**

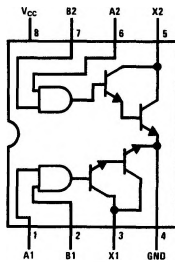

TL/F/5816-2

**Top View**  
Order Number **DS1632J-8**  
or **DS3632N**

See NS Package Number J08A or N08E

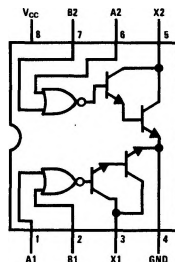

TL/F/5816-3

**Top View**  
Order Number **DS1633J-8**  
or **DS3633N**

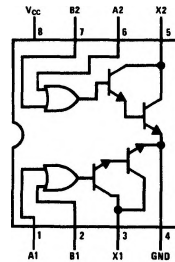

TL/F/5816-4

**Top View**  
Order Number **DS1634J-8**  
or **DS3634N**

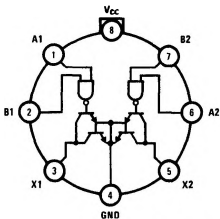

TL/F/5816-5

**Top View**  
(Pin 4 is electrically connected to the case.)  
Order Number **DS1631H**

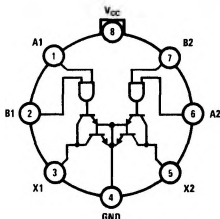

TL/F/5816-6

**Top View**  
(Pin 4 is electrically connected to the case.)  
Order Number **DS1632H**

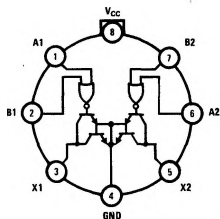

TL/F/5816-7

**Top View**  
(Pin 4 is electrically connected to the case.)  
Order Number **DS1633H**

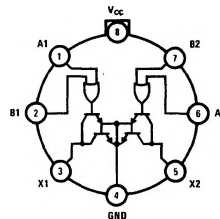

TL/F/5816-8

**Top View**  
(Pin 4 is electrically connected to the case.)  
Order Number **DS1634H**

See NS Package Number H08C

### Absolute Maximum Ratings (Note 1)

If Military/Aerospace specified devices are required, please contact the National Semiconductor Sales Office/Distributors for availability and specifications.

|                                      |                          |
|--------------------------------------|--------------------------|
| Supply Voltage                       | 16V                      |
| Voltage at Inputs                    | -0.3V to $V_{CC} + 0.3V$ |
| Output Voltage                       | 56V                      |
| Storage Temperature Range            | -65°C to +150°C          |
| Maximum Power Dissipation* at 25°C   |                          |
| Cavity Package                       | 1133 mW                  |
| Molded Package                       | 1022 mW                  |
| TO-5 Package                         | 787 mW                   |
| Lead Temperature (Soldering, 4 sec.) | 260°C                    |

\*Derate cavity package 7.6 mW/°C above 25°C; derate molded package 8.2 mW/°C above 25°C; derate TO-5 package 5.2 mW/°C above 25°C.

### Operating Conditions

|                          | Min  | Max  | Units |
|--------------------------|------|------|-------|
| Supply Voltage, $V_{CC}$ |      |      |       |
| DS1631/DS1632/           | 4.5  | 15   | V     |
| DS1633/DS1634            |      |      |       |
| DS3631/DS3632/           | 4.75 | 15   | V     |
| DS3633/DS3634            |      |      |       |
| Temperature, $T_A$       |      |      |       |
| DS1631/DS1632/           | -55  | +125 | °C    |
| DS1633/DS1634            |      |      |       |
| DS3631/DS3632/           | 0    | +70  | °C    |
| DS3633/DS3634            |      |      |       |

### Electrical Characteristics (Notes 2 and 3)

| Symbol               | Parameter                 | Conditions   | Min                          | Typ          | Max  | Units   |         |             |
|----------------------|---------------------------|--|------------------------------|--------------|------|---------|---------|-------------|
| <b>ALL CIRCUITS</b>  |                           |  |                              |              |      |         |         |             |
| $V_{IH}$             | Logical "1" Input Voltage | (Figure 1)   | $V_{CC} = 5V$                | 3.5          | 2.5  |         | V       |             |
|                      |                           |  | $V_{CC} = 10V$               | 8.0          | 5    |         | V       |             |
|                      |                           |  | $V_{CC} = 15V$               | 12.5         | 7.5  |         | V       |             |
| $V_{IL}$             | Logical "0" Input Voltage | (Figure 1)   | $V_{CC} = 5V$                |              | 2.5  | 1.5     | V       |             |
|                      |                           |  | $V_{CC} = 10V$               |              | 5.5  | 2.0     | V       |             |
|                      |                           |  | $V_{CC} = 15V$               |              | 7.5  | 2.5     | V       |             |
| $I_{IH}$             | Logical "1" Input Current | $V_{CC} = 15V, V_{IN} = 15V$ , (Figure 2)  |                              | 0.1          | 10   | $\mu A$ |         |             |
| $I_{IL}$             | Logical "0" Input Current | $V_{IN} = 0.4V$ , (Figure 3)   | $V_{CC} = 5V$                |              | -50  | -120    | $\mu A$ |             |
|                      |                           |  | $V_{CC} = 15V$               |              | -200 | -360    | $\mu A$ |             |
| $V_{OH}$             | Output Breakdown Voltage  | $V_{CC} = 15V, I_{OH} = 250 \mu A$ , (Figure 1)  | 56                           | 65           |      | V       |         |             |
| $V_{OL}$             | Output Low Voltage        | $V_{CC} = \text{Min}$ , (Figure 1), DS1631, DS1632, DS1633, DS1634                           | $I_{OL} = 100 \text{ mA}$    |              | 0.85 | 1.1     | V       |             |
|                      |                           |  | $I_{OL} = 300 \text{ mA}$    |              | 1.1  | 1.4     | V       |             |
|                      |                           | $V_{CC} = \text{Min}$ , (Figure 1), DS3631, DS3632, DS3633, DS3634                           | $I_{OL} = 100 \text{ mA}$    |              | 0.85 | 1.0     | V       |             |
|                      |                           |  | $I_{OL} = 300 \text{ mA}$    |              | 1.1  | 1.3     | V       |             |
| <b>DS1631/DS3631</b> |                           |  |                              |              |      |         |         |             |
| $I_{CC(0)}$          | Supply Currents           | $V_{IN} = 0V$ , (Figure 4)   | $V_{CC} = 5V$                | Output Low   |      | 7       | 11      | $\text{mA}$ |
|                      |                           |  | $V_{CC} = 15V$               | Both Drivers |      | 14      | 20      | $\text{mA}$ |
| $I_{CC(1)}$          |                           | (Figure 4)   | $V_{CC} = 5V, V_{IN} = 5V$   | Output High  |      | 2       | 3       | $\text{mA}$ |
|                      |                           |  | $V_{CC} = 15V, V_{IN} = 15V$ | Both Drivers |      | 7.5     | 10      | $\text{mA}$ |
| $t_{PD1}$            | Propagation to "1"        | $V_{CC} = 5V, T_A = 25^\circ C, C_L = 15 \text{ pF}, R_L = 50\Omega, V_L = 10V$ , (Figure 5) |                              | 500          |      |         | ns      |             |
| $t_{PD0}$            | Propagation to "0"        | $V_{CC} = 5V, T_A = 25^\circ C, C_L = 15 \text{ pF}, R_L = 50\Omega, V_L = 10V$ , (Figure 5) |                              | 750          |      |         | ns      |             |
| <b>DS1632/DS3632</b> |                           |  |                              |              |      |         |         |             |
| $I_{CC(0)}$          | Supply Currents           | (Figure 4)   | $V_{CC} = 5V, V_{IN} = 5V$   | Output Low   |      | 8       | 12      | $\text{mA}$ |
|                      |                           |  | $V_{CC} = 15V, V_{IN} = 15V$ |              |      | 18      | 23      | $\text{mA}$ |
| $I_{CC(1)}$          |                           | $V_{IN} = 0V$ , (Figure 4)   | $V_{CC} = 5V$                | Output High  |      | 2.5     | 3.5     | $\text{mA}$ |
|                      |                           |  | $V_{CC} = 15V$               |              |      | 9       | 14      | $\text{mA}$ |
| $t_{PD1}$            | Propagation to "1"        | $V_{CC} = 5V, T_A = 25^\circ C, C_L = 15 \text{ pF}, R_L = 50\Omega, V_L = 10V$ , (Figure 5) |                              | 500          |      |         | ns      |             |
| $t_{PD0}$            | Propagation to "0"        | $V_{CC} = 5V, T_A = 25^\circ C, C_L = 15 \text{ pF}, R_L = 50\Omega, V_L = 10V$ , (Figure 5) |                              | 750          |      |         | ns      |             |

## Electrical Characteristics (Notes 2 and 3) (Continued)

| Symbol               | Parameter          | Conditions   | Min                          | Typ         | Max | Units |    |
|----------------------|--------------------|--|------------------------------|-------------|-----|-------|----|
| <b>DS1633/DS3633</b> |                    |  |                              |             |     |       |    |
| $I_{CC(0)}$          | Supply Currents    | $V_{IN} = 0V$ , (Figure 4)   | $V_{CC} = 5V$                | Output Low  | 7.5 | 12    | mA |
|                      |                    |  | $V_{CC} = 15V$               |             | 16  | 23    | mA |
| $I_{CC(1)}$          |                    | (Figure 4)   | $V_{CC} = 5V, V_{IN} = 5V$   | Output High | 2   | 4     | mA |
|                      |                    |  | $V_{CC} = 15V, V_{IN} = 15V$ |             | 7.2 | 15    | mA |
| $t_{PD1}$            | Propagation to "1" | $V_{CC} = 5V, T_A = 25^\circ C, C_L = 15 pF, R_L = 50\Omega, V_L = 10V$ , (Figure 5) |                              | 500         |     | ns    |    |
| $t_{PD0}$            | Propagation to "0" | $V_{CC} = 5V, T_A = 25^\circ C, C_L = 15 pF, R_L = 50\Omega, V_L = 10V$ , (Figure 5) |                              | 750         |     | ns    |    |
| <b>DS1634/DS3634</b> |                    |  |                              |             |     |       |    |
| $I_{CC(0)}$          | Supply Currents    | (Figure 4)   | $V_{CC} = 5V, V_{IN} = 5V$   | Output Low  | 7.5 | 12    | mA |
|                      |                    |  | $V_{CC} = 15V, V_{IN} = 15V$ |             | 18  | 23    | mA |
| $I_{CC(1)}$          |                    | $V_{IN} = 0V$ , (Figure 4)   | $V_{CC} = 5V$                | Output High | 3   | 5     | mA |
|                      |                    |  | $V_{CC} = 15V$               |             | 11  | 18    | mA |
| $t_{PD1}$            | Propagation to "1" | $V_{CC} = 5V, T_A = 25^\circ C, C_L = 15 pF, R_L = 50\Omega, V_L = 10V$ , (Figure 5) |                              | 500         |     | ns    |    |
| $t_{PD0}$            | Propagation to "0" | $V_{CC} = 5V, T_A = 25^\circ C, C_L = 15 pF, R_L = 50\Omega, V_L = 10V$ , (Figure 5) |                              | 750         |     | ns    |    |

**Note 1:** "Absolute Maximum Ratings" are those values beyond which the safety of the device cannot be guaranteed. Except for "Operating Temperature Range" they are not meant to imply that the devices should be operated at these limits. The table of "Electrical Characteristics" provides conditions for actual device operation.

**Note 2:** Unless otherwise specified min/max limits apply across the  $-55^\circ C$  to  $+125^\circ C$  temperature range for the DS1631, DS1632, DS1633 and DS1634 and across the  $0^\circ C$  to  $+70^\circ C$  range for the DS3631, DS3632, DS3633 and DS3634. All typical values are for  $T_A = 25^\circ C$ .

**Note 3:** All currents into device pins shown as positive, out of device pins as negative, all voltages referenced to ground unless otherwise noted. All values shown as max or min on absolute value basis.

## Test Circuits

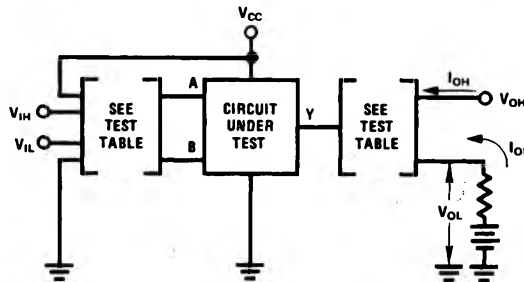

TL/F/5816-9

| Circuit | Input Under Test | Other Input | Output   |          |
|---------|------------------|-------------|----------|----------|
|         |                  |             | Apply    | Measure  |
| DS3631  | $V_{IH}$         | $V_{IH}$    | $I_{OH}$ | $V_{OH}$ |
|         | $V_{IL}$         | $V_{CC}$    | $I_{OL}$ | $V_{OL}$ |
| DS3632  | $V_{IH}$         | $V_{IH}$    | $I_{OL}$ | $V_{OL}$ |
|         | $V_{IL}$         | $V_{CC}$    | $I_{OH}$ | $V_{OH}$ |
| DS3633  | $V_{IH}$         | GND         | $I_{OH}$ | $V_{OH}$ |
|         | $V_{IL}$         | $V_{IL}$    | $I_{OL}$ | $V_{OL}$ |
| DS3634  | $V_{IH}$         | GND         | $I_{OL}$ | $V_{OL}$ |
|         | $V_{IL}$         | $V_{IL}$    | $I_{OH}$ | $V_{OH}$ |

Note: Each input is tested separately.

**FIGURE 1.**  $V_{IH}$ ,  $V_{IL}$ ,  $V_{OH}$ ,  $V_{OL}$

**Test Circuits** (Continued)

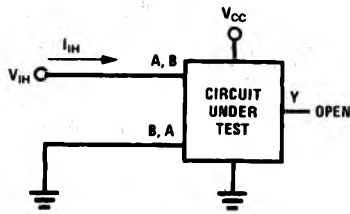

Each Input is tested separately.

**FIGURE 2.  $I_{IH}$**

TL/F/5816-10

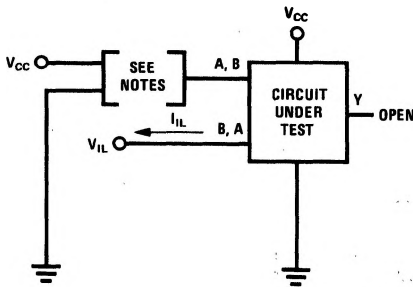

**Note A:** Each input is tested separately.

**Note B:** When testing DS1633 and DS1634 input not under test is grounded. For all other circuits it is at  $V_{CC}$ .

**FIGURE 3.  $I_{IL}$**

TL/F/5816-11

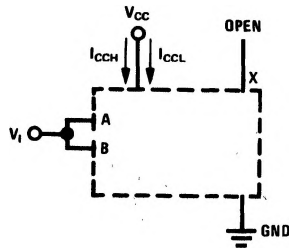

Both gates are tested simultaneously.

**FIGURE 4.  $I_{CC}$  for AND and NAND Circuits**

TL/F/5816-12

**Schematic Diagram** (Equivalent Circuit)

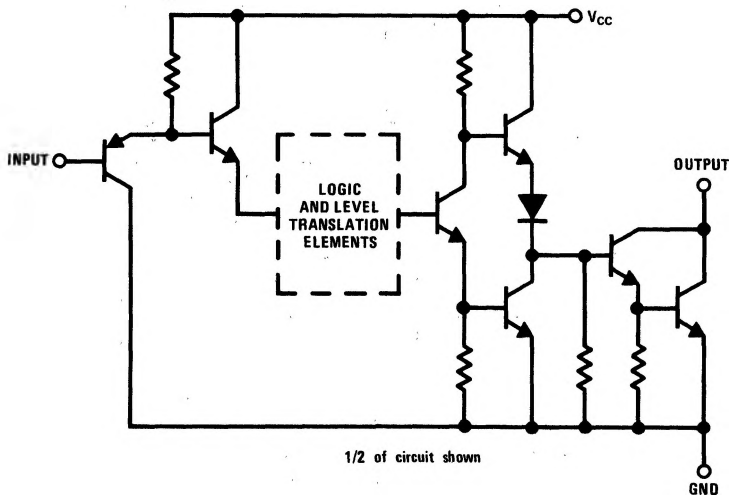

1/2 of circuit shown

TL/F/5816-15

### Switching Time Waveforms

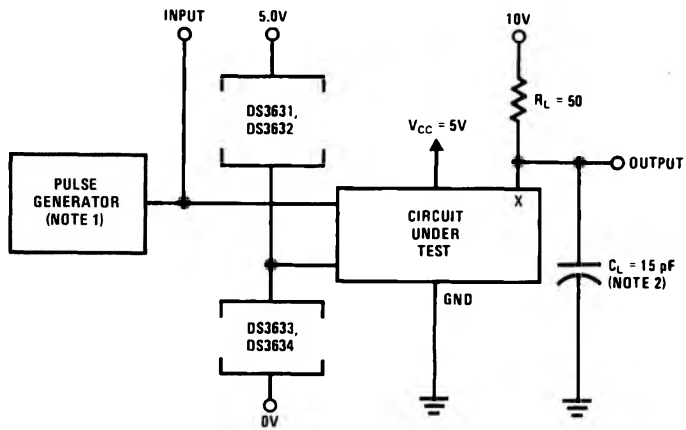

TL/F/5816-13

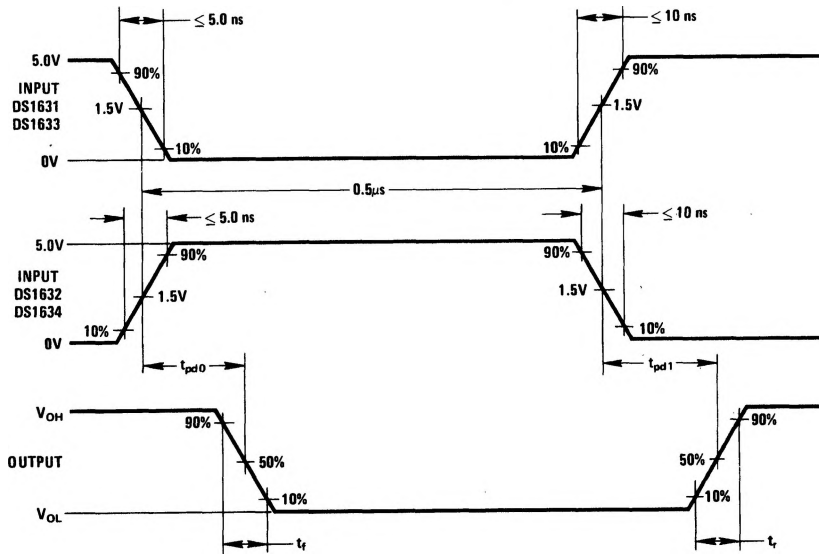

TL/F/5816-14

**Note 1:** The pulse generator has the following characteristics: PRR = 500 kHz,  $Z_{OUT} \approx 50\Omega$

**Note 2:**  $C_L$  includes probe and jig capacitance

**FIGURE 5. Switching Times**