



# DS1631/DS3631/DS1632/DS3632/DS1633/DS3633/ DS1634/DS3634 CMOS Dual Peripheral Drivers

## General Description

The DS1631 series of dual peripheral drivers was designed to be a universal set of interface components for CMOS circuits.

Each circuit has CMOS compatible inputs with thresholds that track as a function of  $V_{CC}$  (approximately  $\frac{1}{2} V_{CC}$ ). The inputs are PNPs providing the high impedance necessary for interfacing with CMOS.

Outputs have high voltage capability, minimum breakdown voltage is 56V at 250  $\mu$ A.

The outputs are Darlington connected transistors. This allows high current operation (300 mA max) at low internal  $V_{CC}$  current levels since base drive for the output transistor is obtained from the load in proportion to the required loading conditions. This is essential in order to minimize loading on the CMOS logic supply.

Typical  $V_{CC} = 5V$  power is 28 mW with both outputs ON.  $V_{CC}$  operating range is 4.5V to 15V.

The circuit also features output transistor protection if the  $V_{CC}$  supply is lost by forcing the output into the high impedance OFF state with the same breakdown levels as when  $V_{CC}$  was applied.

Pin-outs are the same as the respective logic functions found in the following popular series of circuits: DS75451, DS75461. This feature allows direct conversion of present systems to the MM74C CMOS family and DS1631 series circuits with great power savings.

The DS1631 series is also TTL compatible at  $V_{CC} = 5V$ .

## Features

- CMOS compatible inputs
- High impedance inputs PNP's
- High output voltage breakdown 56V min
- High output current capability 300 mA max
- Same pin-outs and logic functions as DS75451 and DS75461 series circuits
- Low  $V_{CC}$  power dissipation (28 mW both outputs "ON" at 5V)

## Connection Diagrams (Dual-In-Line and Metal Can Packages)

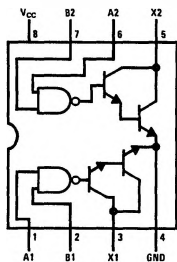

**Top View**  
Order Number DS1631J-8  
or DS3631N

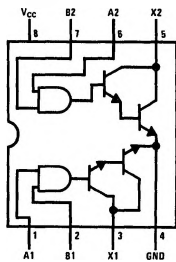

**Top View**  
Order Number DS1632J-8  
or DS3632N

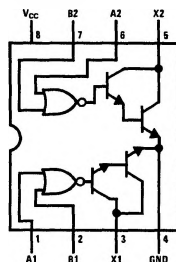

**Top View**  
Order Number DS1633J-8  
or DS3633N

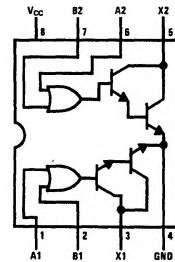

**Top View**  
Order Number DS1634J-8  
or DS3634N

See NS Package Number J08A or N08E

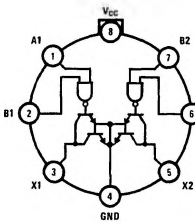

**Top View**

(Pin 4 is electrically connected to the case.)

Order Number DS1631H

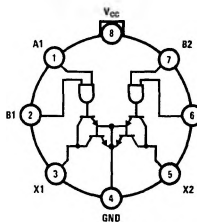

**Top View**

(Pin 4 is electrically connected to the case.)

Order Number DS1632H

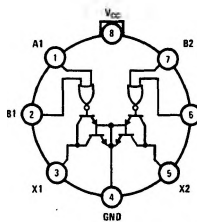

**Top View**

(Pin 4 is electrically connected to the case.)

Order Number DS1633H

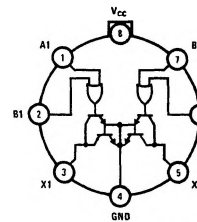

**Top View**

(Pin 4 is electrically connected to the case.)

Order Number DS1634H

See NS Package Number H08C

### Absolute Maximum Ratings (Note 1)

If Military/Aerospace specified devices are required, please contact the National Semiconductor Sales Office/Distributors for availability and specifications.

Supply Voltage	16V
Voltage at Inputs	-0.3V to $V_{CC} + 0.3V$
Output Voltage	56V
Storage Temperature Range	-65°C to +150°C
Maximum Power Dissipation* at 25°C	
Cavity Package	1133 mW
Molded Package	1022 mW
TO-5 Package	787 mW
Lead Temperature (Soldering, 4 sec.)	260°C

\*Derate cavity package 7.6 mW/°C above 25°C; derate molded package 8.2 mW/°C above 25°C; derate TO-5 package 5.2 mW/°C above 25°C.

### Operating Conditions

	Min	Max	Units
Supply Voltage, $V_{CC}$			
DS1631/DS1632/DS1633/DS1634	4.5	15	V
DS3631/DS3632/DS3633/DS3634	4.75	15	V
Temperature, $T_A$			
DS1631/DS1632/DS1633/DS1634	-55	+125	°C
DS3631/DS3632/DS3633/DS3634	0	+70	°C

### Electrical Characteristics (Notes 2 and 3)

Symbol	Parameter	Conditions	Min	Typ	Max	Units		
<b>ALL CIRCUITS</b>								
$V_{IH}$	Logical "1" Input Voltage	(Figure 1)	$V_{CC} = 5V$	3.5	2.5		V	
			$V_{CC} = 10V$	8.0	5		V	
			$V_{CC} = 15V$	12.5	7.5		V	
$V_{IL}$	Logical "0" Input Voltage	(Figure 1)	$V_{CC} = 5V$		2.5	1.5	V	
			$V_{CC} = 10V$		5.5	2.0	V	
			$V_{CC} = 15V$		7.5	2.5	V	
$I_{IH}$	Logical "1" Input Current	$V_{CC} = 15V, V_{IN} = 15V$ , (Figure 2)		0.1	10	$\mu A$		
$I_{IL}$	Logical "0" Input Current	$V_{IN} = 0.4V$ , (Figure 3)	$V_{CC} = 5V$		-50	-120	$\mu A$	
			$V_{CC} = 15V$		-200	-360	$\mu A$	
$V_{OH}$	Output Breakdown Voltage	$V_{CC} = 15V, I_{OH} = 250 \mu A$ , (Figure 1)	56	65		V		
$V_{OL}$	Output Low Voltage	$V_{CC} = \text{Min}$ , (Figure 1), DS1631, DS1632, DS1633, DS1634	$I_{OL} = 100 \text{ mA}$		0.85	1.1	V	
			$I_{OL} = 300 \text{ mA}$		1.1	1.4	V	
		$V_{CC} = \text{Min}$ , (Figure 1), DS3631, DS3632, DS3633, DS3634	$I_{OL} = 100 \text{ mA}$		0.85	1.0	V	
			$I_{OL} = 300 \text{ mA}$		1.1	1.3	V	
<b>DS1631/DS3631</b>								
$I_{CC(0)}$	Supply Currents	$V_{IN} = 0V$ , (Figure 4)	$V_{CC} = 5V$	Output Low		7	11	$\text{mA}$
			$V_{CC} = 15V$	Both Drivers		14	20	$\text{mA}$
$I_{CC(1)}$		(Figure 4)	$V_{CC} = 5V, V_{IN} = 5V$	Output High		2	3	$\text{mA}$
			$V_{CC} = 15V, V_{IN} = 15V$	Both Drivers		7.5	10	$\text{mA}$
$t_{PD1}$	Propagation to "1"	$V_{CC} = 5V, T_A = 25^\circ C, C_L = 15 \text{ pF}, R_L = 50\Omega, V_L = 10V$ , (Figure 5)			500		ns	
$t_{PD0}$	Propagation to "0"	$V_{CC} = 5V, T_A = 25^\circ C, C_L = 15 \text{ pF}, R_L = 50\Omega, V_L = 10V$ , (Figure 5)			750		ns	
<b>DS1632/DS3632</b>								
$I_{CC(0)}$	Supply Currents	(Figure 4)	$V_{CC} = 5V, V_{IN} = 5V$	Output Low		8	12	$\text{mA}$
			$V_{CC} = 15V, V_{IN} = 15V$			18	23	$\text{mA}$
$I_{CC(1)}$		$V_{IN} = 0V$ , (Figure 4)	$V_{CC} = 5V$	Output High		2.5	3.5	$\text{mA}$
			$V_{CC} = 15V$			9	14	$\text{mA}$
$t_{PD1}$	Propagation to "1"	$V_{CC} = 5V, T_A = 25^\circ C, C_L = 15 \text{ pF}, R_L = 50\Omega, V_L = 10V$ , (Figure 5)			500		ns	
$t_{PD0}$	Propagation to "0"	$V_{CC} = 5V, T_A = 25^\circ C, C_L = 15 \text{ pF}, R_L = 50\Omega, V_L = 10V$ , (Figure 5)			750		ns	

## Electrical Characteristics (Notes 2 and 3) (Continued)

Symbol	Parameter	Conditions		Min	Typ	Max	Units
<b>DS1633/DS3633</b>							
I <sub>CC(0)</sub>	Supply Currents	V <sub>IN</sub> = 0V, (Figure 4)	V <sub>CC</sub> = 5V	Output Low	7.5	12	mA
			V <sub>CC</sub> = 15V		16	23	mA
I <sub>CC(1)</sub>		(Figure 4)	V <sub>CC</sub> = 5V, V <sub>IN</sub> = 5V	Output High	2	4	mA
			V <sub>CC</sub> = 15V, V <sub>IN</sub> = 15V		7.2	15	mA
t <sub>PD1</sub>	Propagation to "1"	V <sub>CC</sub> = 5V, T <sub>A</sub> = 25°C, C <sub>L</sub> = 15 pF, R <sub>L</sub> = 50Ω, V <sub>L</sub> = 10V, (Figure 5)			500		ns
t <sub>PD0</sub>	Propagation to "0"	V <sub>CC</sub> = 5V, T <sub>A</sub> = 25°C, C <sub>L</sub> = 15 pF, R <sub>L</sub> = 50Ω, V <sub>L</sub> = 10V, (Figure 5)			750		ns
<b>DS1634/DS3634</b>							
I <sub>CC(0)</sub>	Supply Currents	(Figure 4)	V <sub>CC</sub> = 5V, V <sub>IN</sub> = 5V	Output Low	7.5	12	mA
			V <sub>CC</sub> = 15V, V <sub>IN</sub> = 15V		18	23	mA
I <sub>CC(1)</sub>		V <sub>IN</sub> = 0V, (Figure 4)	V <sub>CC</sub> = 5V	Output High	3	5	mA
			V <sub>CC</sub> = 15V		11	18	mA
t <sub>PD1</sub>	Propagation to "1"	V <sub>CC</sub> = 5V, T <sub>A</sub> = 25°C, C <sub>L</sub> = 15 pF, R <sub>L</sub> = 50Ω, V <sub>L</sub> = 10V, (Figure 5)			500		ns
t <sub>PD0</sub>	Propagation to "0"	V <sub>CC</sub> = 5V, T <sub>A</sub> = 25°C, C <sub>L</sub> = 15 pF, R <sub>L</sub> = 50Ω, V <sub>L</sub> = 10V, (Figure 5)			750		ns

**Note 1:** "Absolute Maximum Ratings" are those values beyond which the safety of the device cannot be guaranteed. Except for "Operating Temperature Range" they are not meant to imply that the devices should be operated at these limits. The table of "Electrical Characteristics" provides conditions for actual device operation.

**Note 2:** Unless otherwise specified min/max limits apply across the -55°C to +125°C temperature range for the DS1631, DS1632, DS1633 and DS1634 and across the 0°C to +70°C range for the DS3631, DS3632, DS3633 and DS3634. All typical values are for T<sub>A</sub> = 25°C.

**Note 3:** All currents into device pins shown as positive, out of device pins as negative, all voltages referenced to ground unless otherwise noted. All values shown as max or min on absolute value basis.

## Test Circuits

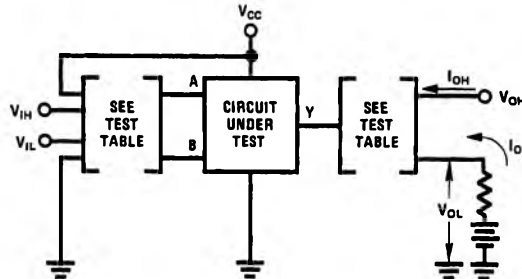

TL/F/5816-9

Circuit	Input Under Test	Other Input	Output	
			Apply	Measure
DS3631	V <sub>IH</sub> V <sub>IL</sub>	V <sub>IH</sub> V <sub>CC</sub>	I <sub>OH</sub> I <sub>OL</sub>	V <sub>OH</sub> V <sub>OL</sub>
DS3632	V <sub>IH</sub> V <sub>IL</sub>	V <sub>IH</sub> V <sub>CC</sub>	I <sub>OL</sub> I <sub>OH</sub>	V <sub>OL</sub> V <sub>OH</sub>
DS3633	V <sub>IH</sub> V <sub>IL</sub>	GND V <sub>IL</sub>	I <sub>OH</sub> I <sub>OL</sub>	V <sub>OH</sub> V <sub>OL</sub>
DS3634	V <sub>IH</sub> V <sub>IL</sub>	GND V <sub>IL</sub>	I <sub>OL</sub> I <sub>OH</sub>	V <sub>OL</sub> V <sub>OH</sub>

Note: Each input is tested separately.

**FIGURE 1. V<sub>IH</sub>, V<sub>IL</sub>, V<sub>OH</sub>, V<sub>OL</sub>**

**Test Circuits** (Continued)

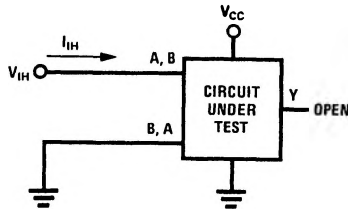

Each input is tested separately.

**FIGURE 2.  $I_{IH}$**

TL/F/5816-10

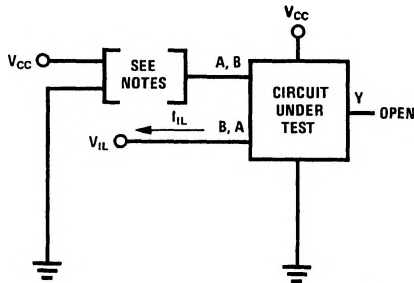

TL/F/5816-11

**Note A:** Each input is tested separately.

**Note B:** When testing DS1633 and DS1634 input not under test is grounded. For all other circuits it is at  $V_{CC}$ .

**FIGURE 3.  $I_{IL}$**

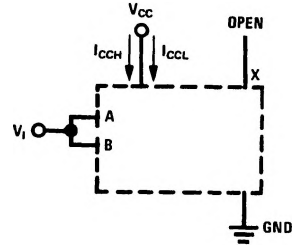

TL/F/5816-12

Both gates are tested simultaneously.

**FIGURE 4.  $I_{CC}$  for AND and NAND Circuits**

**Schematic Diagram** (Equivalent Circuit)

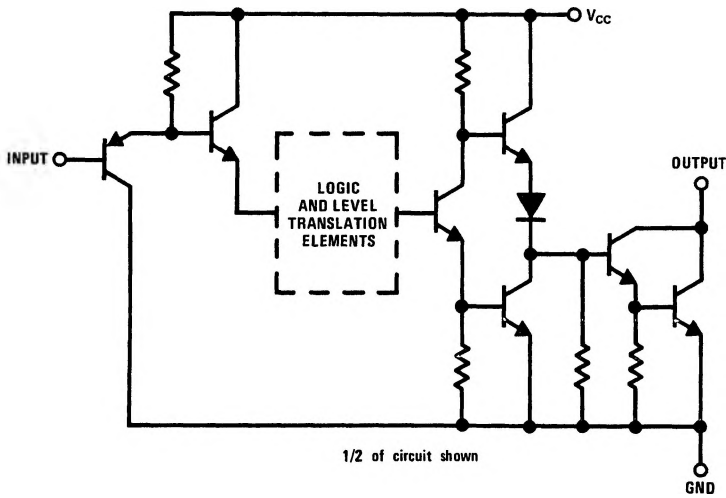

TL/F/5816-15

# Switching Time Waveforms

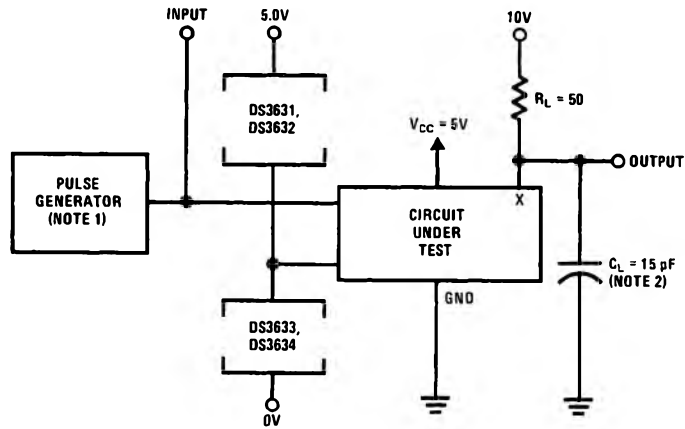

TL/F/5816-13

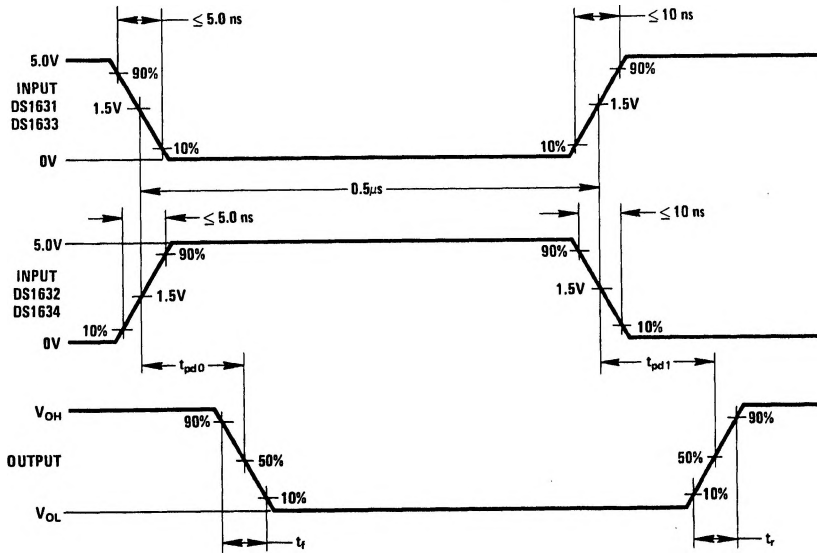

TL/F/5816-14

**Note 1:** The pulse generator has the following characteristics: PRR = 500 kHz,  $Z_{OUT} \approx 50\Omega$

**Note 2:**  $C_L$  includes probe and jig capacitance

**FIGURE 5. Switching Times**