

# DS26LS32C/DS26LS32M/DS26LS32AC/DS26LS33C/ DS26LS33M/DS26LS33AC Quad Differential Line Receivers

## General Description

The DS26LS32 and DS26LS32A are quad differential line receivers designed to meet the RS-422, RS-423 and Federal Standards 1020 and 1030 for balanced and unbalanced digital data transmission.

The DS26LS32 and DS26LS32A have an input sensitivity of 200 mV over the input voltage range of  $\pm 7V$  and the DS26LS33 and DS26LS33A have an input sensitivity of 500 mV over the input voltage range of  $\pm 15V$ .

Both the DS26LS32A and DS26LS33A differ in function from the popular DS26LS32 and DS26LS33 in that input pull-up and pull-down resistors are included which prevent output oscillation on unused channels.

Each version provides an enable and disable function common to all four receivers and features TRI-STATE® outputs with 8 mA sink capability. Constructed using low power Schottky processing, these devices are available over the full military and commercial operating temperature ranges.

## Features

- High differential or common-mode input voltage ranges of  $\pm 7V$  on the DS26LS32 and DS26LS32A and  $\pm 15V$  on the DS26LS33 and DS26LS33A
- $\pm 0.2V$  sensitivity over the input voltage range on the DS26LS32 and DS26LS32A,  $\pm 0.5V$  sensitivity on the DS26LS33 and DS26LS33A
- DS26LS32 and DS26LS32A meet all requirements of RS-422 and RS-423
- 6k minimum input impedance
- 100 mV input hysteresis on the DS26LS32 and DS26LS32A, 200 mV on the DS26LS33 and DS26LS33A
- Operation from a single 5V supply
- TRI-STATE outputs, with choice of complementary output enables for receiving directly onto a data bus

## Logic Diagram

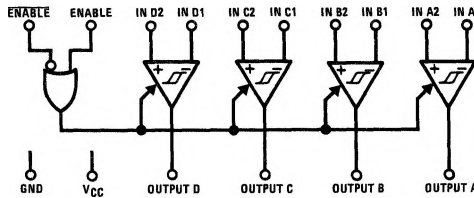

TL/F/5255-1

## Connection Diagram

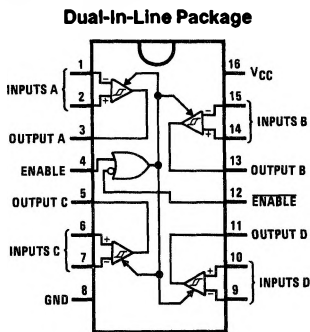

Top View

TL/F/5255-2

## Truth Table

ENABLE	ENABBLE	Input	Output
0	1	X	Hi-Z
See Note Below		$V_{ID} \geq V_{TH} (Max)$	1
		$V_{ID} \leq V_{TH} (Min)$	0

Hi-Z = TRI-STATE

Note: Input conditions may be any combination not defined for ENABLE and ENABBLE.

**Order Number DS26LS32CM, DS26LS32CN,  
DS26LS32MJ, DS26LS32ACM, DS26LS32ACN,  
DS26LS33CN, DS26LS33MJ or DS26LS33ACN  
See NS Package Number J16A, M16A or N16A**

**For Complete Military 883 Specifications,  
See RETS Data Sheet.**

**Order Number DS26LS32MJ/883, DS26LS32MW/883,  
DS26LS33MJ/883, DS26LS33MW/883  
See NS Package Number J16A or W16A**

**Absolute Maximum Ratings** (Note 1)

If Military/Aerospace specified devices are required, please contact the National Semiconductor Sales Office/Distributors for availability and specifications.

Supply Voltage	7V
Common-Mode Range	±25V
Differential Input Voltage	±25V
Enable Voltage	7V
Output Sink Current	50 mA
Maximum Power Dissipation* at 25°C	
Cavity Package	1433 mW
Molded Dip Package	1362 mW
SO Package DS26LS32	1002 mW
DS26LS32A	1051 mW

\*Derate cavity package 9.6 mW/°C above 25°C; derate molded DIP package 10.9 mW/°C above 25°C.

Derate SO Package 8.01 mW/°C for DS26LS32  
8.41 mW/°C for DS26LS32A

Storage Temperature Range	-65°C to +165°C
Lead Temperature (Soldering, 4 seconds)	260°C

**Operating Conditions**

	Min	Max	Units
Supply Voltage, (V <sub>CC</sub> )			
DS26LS32M, DS26LS33M (MIL)	4.5	5.5	V
DS26LS32C, DS26LS33C (COML)	4.75	5.25	V
Temperature, (T <sub>A</sub> )			
DS26LS32M, DS26LS33M (MIL)	-55	+125	°C
DS26LS32C, DS26LS33C (COML)	0	+70	°C

**Electrical Characteristics** over the operating temperature range unless otherwise specified (Notes 2, 3 and 4)

Symbol	Parameter	Conditions	Min	Typ	Max	Units	
V <sub>TH</sub>	Differential Input Voltage	V <sub>OUT</sub> = V <sub>OH</sub> or V <sub>OL</sub> DS26LS32, DS26LS32A, -7V ≤ V <sub>CM</sub> ≤ +7V	-0.2	±0.07	0.2	V	
		DS26LS33, DS26LS33A, -15V ≤ V <sub>CM</sub> + 15V	-0.5	±0.14	0.5	V	
R <sub>IN</sub>	Input Resistance	-15V ≤ V <sub>CM</sub> ≤ +15V (One Input AC GND)	6.0	8.5		kΩ	
I <sub>IN</sub>	Input Current (Under Test)	V <sub>IN</sub> = 15V, Other Input -15V ≤ V <sub>IN</sub> ≤ +15V			2.3	mA	
		V <sub>IN</sub> = -15V, Other Input -15V ≤ V <sub>IN</sub> ≤ +15V			-2.8	mA	
V <sub>OH</sub>	Output High Voltage	V <sub>CC</sub> = MIN, ΔV <sub>IN</sub> = 1V, V <sub>ENABLE</sub> = 0.8V, I <sub>OH</sub> = -440 μA	Commercial	2.7	4.2		V
			Military	2.5	4.2		V
V <sub>OL</sub>	Output Low Voltage	V <sub>CC</sub> = Min, ΔV <sub>IN</sub> = -1V, V <sub>ENABLE</sub> = 0.8V	I <sub>OL</sub> = 4 mA			0.4	V
			I <sub>OL</sub> = 8 mA			0.45	V
V <sub>IL</sub>	Enable Low Voltage				0.8	V	
V <sub>IH</sub>	Enable High Voltage		2.0			V	
V <sub>I</sub>	Enable Clamp Voltage	V <sub>CC</sub> = Min, I <sub>IN</sub> = -18 mA			-1.5	V	
I <sub>O</sub>	OFF-State (High Impedance) Output Current	V <sub>CC</sub> = Max	V <sub>O</sub> = 2.4V			20	μA
			V <sub>O</sub> = 0.4V			-20	μA
I <sub>IL</sub>	Enable Low Current	V <sub>IN</sub> = 0.4V			-0.36	mA	
I <sub>IH</sub>	Enable High Current	V <sub>IN</sub> = 2.7V			20	μA	
I <sub>SC</sub>	Output Short-Circuit Current	V <sub>O</sub> = 0V, V <sub>CC</sub> = Max, ΔV <sub>IN</sub> = 1V	-15		-85	mA	
I <sub>CC</sub>	Power Supply Current	V <sub>CC</sub> = Max, All V <sub>IN</sub> = GND, Outputs Disabled	DS26LS32, DS26LS32A	52	70	mA	
			DS26LS33, DS26LS33A	57	80	mA	
I <sub>I</sub>	Input High Current	V <sub>IN</sub> = 5.5V			100	μA	
V <sub>HYST</sub>	Input Hysteresis	T <sub>A</sub> = 25°C, V <sub>CC</sub> = 5V, V <sub>CM</sub> = 0V	DS26LS32, DS26LS32A	100		mV	
			DS26LS33, DS26LS33A	200		mV	

Note 1: "Absolute Maximum Ratings" are those values beyond which the safety of the device cannot be guaranteed. They are not meant to imply that the device should be operated at these limits. The table of "Electrical Characteristics" provides conditions for actual device operation.

Note 2: All currents into device pins are shown as positive, all currents out of device pins are shown as negative, all voltages are referenced to ground, unless otherwise specified. All values shown as max or min are so classified on absolute value basis.

Note 3: All typical values are V<sub>CC</sub> = 5V, T<sub>A</sub> = 25°C.

Note 4: Only one output at a time should be shorted.

## Switching Characteristics $V_{CC} = 5V, T_A = 25^\circ C$

Symbol	Parameter	Conditions	DS26LS32/DS26LS33			DS26LS32A/DS26LS33A			Units
			Min	Typ	Max	Min	Typ	Max	
$t_{PLH}$	Input to Output	$C_L = 15 \text{ pF}$		17	25		23	35	ns
$t_{PHL}$	Input to Output	$C_L = 15 \text{ pF}$		17	25		23	35	ns
$t_{LZ}$	ENABLE to Output	$C_L = 5 \text{ pF}$		20	30		15	30	ns
$t_{HZ}$	ENABLE to Output	$C_L = 5 \text{ pF}$		15	22		20	25	ns
$t_{ZL}$	ENABLE to Output	$C_L = 15 \text{ pF}$		15	22		14	22	ns
$t_{ZH}$	ENABLE to Output	$C_L = 15 \text{ pF}$		15	22		15	22	ns

## AC Test Circuit and Switching Time Waveforms

### Load Test Circuit for TRI-STATE Outputs

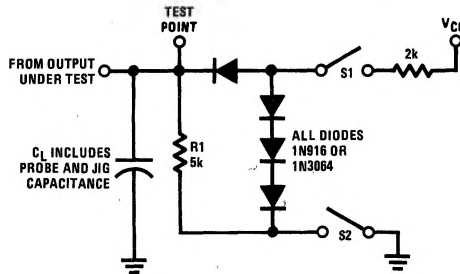

TL/F/5255-3

### Propagation Delay (Notes 1 and 3)

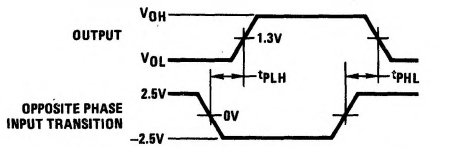

TL/F/5255-4

Note 1: Diagram shown for ENABLE low.

Note 2: S1 and S2 of load circuit are closed except where shown.

Note 3: Pulse generator for all pulses: Rate = 1.0 MHz;  $Z_0 = 50\Omega$ ;  $t_r \leq 6 \text{ ns}$ ;  $t_f \leq 6.0 \text{ ns}$ .

### Enable and Disable Times (Notes 2 and 3)

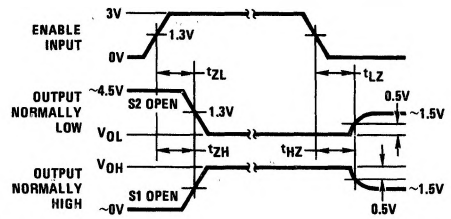

TL/F/5255-5

## Typical Applications

### Two-Wire Balanced Interface—RS-422

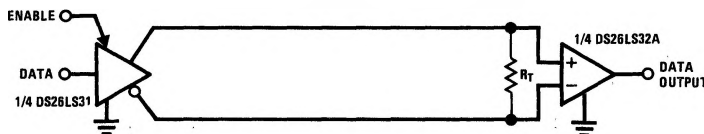

TL/F/5255-6

### Single Wire with Driver Ground Reference—RS-423

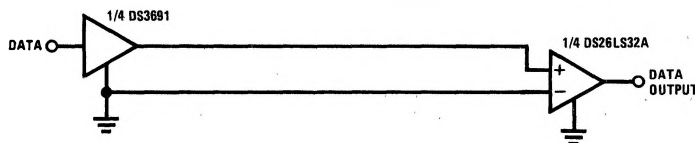

TL/F/5255-7