



Tri-State Logic

DM7230/DM8230 tri-state demultiplexer general description

The DM7230/DM8230 demultiplexer is another device in National's tri-state logic family.

Digital signals applied to two input lines can be routed to two-of-four output lines depending upon the logic on the Address inputs. Outputs can be directly connected to other similar outputs for use in bus-organized systems.

features

- Series 54/74 compatible
- 20 ns propagation delay
- Data complement capability
- Very low output impedance—high drive capability
- Separate input disable controls
- High-impedance output state which allows many outputs to be connected to a common bus-line.

mode of operation

COMPLEMENT AND DATA INPUTS

When Complement A is a logical "1", Data A will appear inverted at the output. When Complement A is a logical "0", Data A will appear non-inverted at the output.

This function is accomplished on the chip through the use of a two-input exclusive-OR gate with Complement A and Data A as the two inputs. Therefore, the A information that is routed to the

outputs is actually (Complement A \oplus Data A). That this is the case may be verified by examining the logic diagram.

The two inputs of this exclusive-OR gate have identical characteristics, allowing the functions of these two inputs to be reversed. Also the propagation delay from either input to the output will be the same. This is also true for the Complement B and Data B inputs.

ADDRESS INPUTS

The Address A inputs select to which of the four outputs A information will be routed. The same is true for the Address B inputs and B information. If A and B information are both routed to the same output simultaneously, that output will be a logical "0" if either the A or B information is a logical "0". All outputs which are not selected for either A or B information will be in the logical "1" state.

DISABLE INPUTS

The Disable inputs are similar to higher order Address inputs in that when Disable A is a logical "1", A information is not routed to any output. All four outputs are nonselected for A information. The same is true for Disable B and B information. The Disable inputs have the additional feature that when both Disable A and Disable B are a logical "1" all outputs go to the High Impedance state. When multiple outputs are connected to a bus line, only one device at a time can be in the

(Continued on Page 22)

logic and connection diagrams

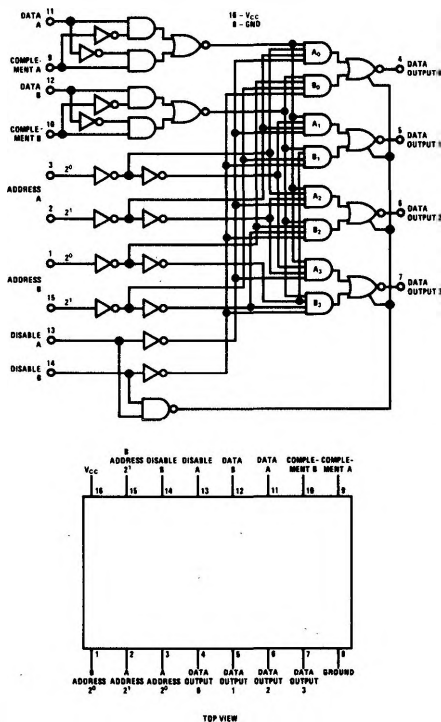

logic table

DATA A	COMP A	DATA B	COMP B	ADDRESS A 2 ¹	ADDRESS A 2 ⁰	ADDRESS B 2 ¹	ADDRESS B 2 ⁰	DIS A	DIS B	OUT 0	OUT 1	OUT 2	OUT 3
0	0	X	X	0	0	X	X	0	1	0	1	1	1
0	1	X	X	0	0	X	X	0	1	1	1	1	1
1	0	X	X	0	0	X	X	0	1	1	1	1	1
1	1	X	X	0	0	X	X	0	1	1	1	1	1
0	0	X	X	0	1	X	X	0	1	1	0	1	1
0	1	X	X	0	1	X	X	0	1	1	1	1	1
1	0	X	X	0	1	X	X	0	1	1	1	1	1
1	1	X	X	0	1	X	X	0	1	1	1	1	1
0	0	X	X	1	0	X	X	0	1	1	1	0	1
0	1	X	X	1	0	X	X	0	1	1	1	1	1
1	0	X	X	1	0	X	X	0	1	1	1	1	1
1	1	X	X	1	0	X	X	0	1	1	1	1	1
0	0	X	X	1	1	X	X	0	1	1	1	1	0
0	1	X	X	1	1	X	X	0	1	1	1	1	1
1	0	X	X	1	1	X	X	0	1	1	1	1	1
1	1	X	X	1	1	X	X	0	1	1	1	1	0
X	X	0	0	X	X	0	0	1	0	0	1	1	1
X	X	0	1	X	X	0	0	1	0	1	1	1	1
X	X	1	0	X	X	0	0	1	0	1	1	1	1
X	X	1	1	X	X	0	0	1	0	1	1	1	1
X	X	0	0	X	X	1	0	1	0	1	1	0	1
X	X	0	1	X	X	1	0	1	0	1	1	1	1
X	X	1	0	X	X	1	0	1	0	1	1	1	1
X	X	1	1	X	X	1	0	1	0	1	1	1	0
X	X	X	X	X	X	X	X	1	1	Hi-Z	Hi-Z	Hi-Z	Hi-Z

absolute maximum ratings

Supply Voltage	7V
Input Voltage	5.5V
Output Voltage	5.5V
Time that two bus-connected devices may be in opposite low impedance states simultaneously. (5% duty cycle)	10 msec
Storage Temperature Range	-65°C to +150°C
Operating Temperature Range	-55°C to +125°C
DM7230	0°C to +70°C
DM8230	300°C
Lead Temperature (Soldering, 10 sec)	

electrical characteristics (Note 1)

PARAMETER	CONDITIONS	MIN	TYP	MAX	UNITS
Logical "1" Input Voltage	DM7230 $V_{CC} = 4.5V$ DM8230 $V_{CC} = 4.75V$	2.0			V
Logical "0" Input Voltage	DM7230 $V_{CC} = 4.5V$ DM8230 $V_{CC} = 4.75V$			0.8	V
Logical "1" Output Voltage	DM7230 $V_{CC} = 4.5V, I_{OUT} = -2 mA$ DM8230 $V_{CC} = 4.75V, I_{OUT} = -5.2 mA$	2.4	3.5		V
Logical "0" Output Voltage	DM7230 $V_{CC} = 4.5V$ DM8230 $V_{CC} = 4.75V, I_{OUT} = 16 mA$		0.2	0.4	V
Logical "0" Input Current	DM7230 $V_{CC} = 5.5V, V_{IN} = 0.4V$ DM8230 $V_{CC} = 5.25V$				
	Disable inputs		-2.0	-3.2	mA
	All other inputs		-1.0	-1.6	mA
Logical "1" Input Current	DM7230 $V_{CC} = 5.5V, V_{IN} = 2.4V$ DM8230 $V_{CC} = 5.25V$				
	Disable inputs			80	μA
	All other inputs			40	μA
Logical "1" Input Current	DM7230 $V_{CC} = 5.5V, V_{IN} = 5.5V$ DM8230 $V_{CC} = 5.25V$			1.0	mA
Output Disable Current	DM7230 $V_{CC} = 5.5V, V_O = 2.4V$ DM8230 $V_{CC} = 5.25V, V_O = 0.4V$			40	μA
				-40	μA
Output Short Current (Note 2)	DM7230 $V_{CC} = 5.5V, V_O = 0.0V$ DM8230 $V_{CC} = 5.25V$	-30		-70	mA
		-28			
Supply Current	DM7230 $V_{CC} = 5.5V, V_{IN} = 5.0V$ DM8230 $V_{CC} = 5.25V$		48	75	mA
Input Diode Clamp Voltage	$V_{CC} = 5.0V, T_A = 25^\circ C$ $I_{IN} = -12 mA$			-1.5	V
Output Diode Clamp Voltage	$V_{CC} = 5.0V, T_A = 25^\circ C$ $I_{OUT} = -12 mA$ $I_{OUT} = +12 mA$			-1.5	V
				$V_{CC} + 1.5$	V
Propagation Delay to Logical "1" from Data or Complement Input, t_{pd1}	$V_{CC} = 5.0V, T_A = 25^\circ C$ $C_L = 50 pF$ Noninverting Inverting		13 20	24 36	ns ns
Propagation Delay to Logical "0" from Data or Complement Input, t_{pd0}	$V_{CC} = 5.0V, T_A = 25^\circ C$ $C_L = 50 pF$ Noninverting or Inverting		18	26	ns
Propagation Delay to Logical "1" from Address Input, t_{pd1} (Note 3)	$V_{CC} = 5.0V, T_A = 25^\circ C$ $C_L = 50 pF$		20	36	ns
Propagation Delay to Logical "0" from Address Input, t_{pd0} (Note 3)	$V_{CC} = 5.0V, T_A = 25^\circ C$ $C_L = 50 pF$		20	30	ns
Propagation Delay to Logical "1" from Disable Input, t_{pd1} (Note 4)	$V_{CC} = 5.0V, T_A = 25^\circ C$ $C_L = 50 pF$		13	25	ns
Propagation Delay to Logical "0" from Disable Input, t_{pd0} (Note 4)	$V_{CC} = 5.0V, T_A = 25^\circ C$ $C_L = 50 pF$		16	25	ns
Delay from Disable Input to High Impedance State (Note 5), t_{IH}	$V_{CC} = 5.0V, T_A = 25^\circ C$		7	14	ns
			15	27	ns
Delay from Disable Input to Low Impedance State (Note 5), t_{HL}	$V_{CC} = 5.0V, T_A = 25^\circ C$ $C_L = 50 pF$		15	23	ns
			18	27	ns

Note 1: Min/max values apply across the -55°C to +125°C temperature range for the DM7230 and across the 0°C to 70°C range for the DM8230 unless otherwise specified. Typicals are given for $T_A = 25^\circ C$ and $V_{CC} = 5.0V$.

Note 2: Only one output at a time should be short circuited.

Note 3: The only conditions under which a t_{pd0} from the Address inputs can be observed is when an output goes from being nonselected to being selected and the information being routed to that output is a logical "0". If the information had been a logical "1", no change would have occurred and no measurement could have been made. Similarly, the only time a t_{pd1} from the Address inputs can be observed, is when an output goes from being selected to being nonselected and the information that had been routed to that output was a logical "0". If the information had been a logical "1", no change would have occurred and no measurement could have been made.

Note 4: Information in Note 3 concerning t_{pd0} and t_{pd1} from the address inputs are applicable here also.

Note 5: All delays involving transitions to or from the High Impedance state are measured with respect to the Disable inputs. For example, with A information at a logical "0" and Disable B at a logical "1" the selected output will go from a logical "0" to the High Impedance state some time, t_{OH} , after Disable A has gone from a logical "0" to a logical "1"

typical performance

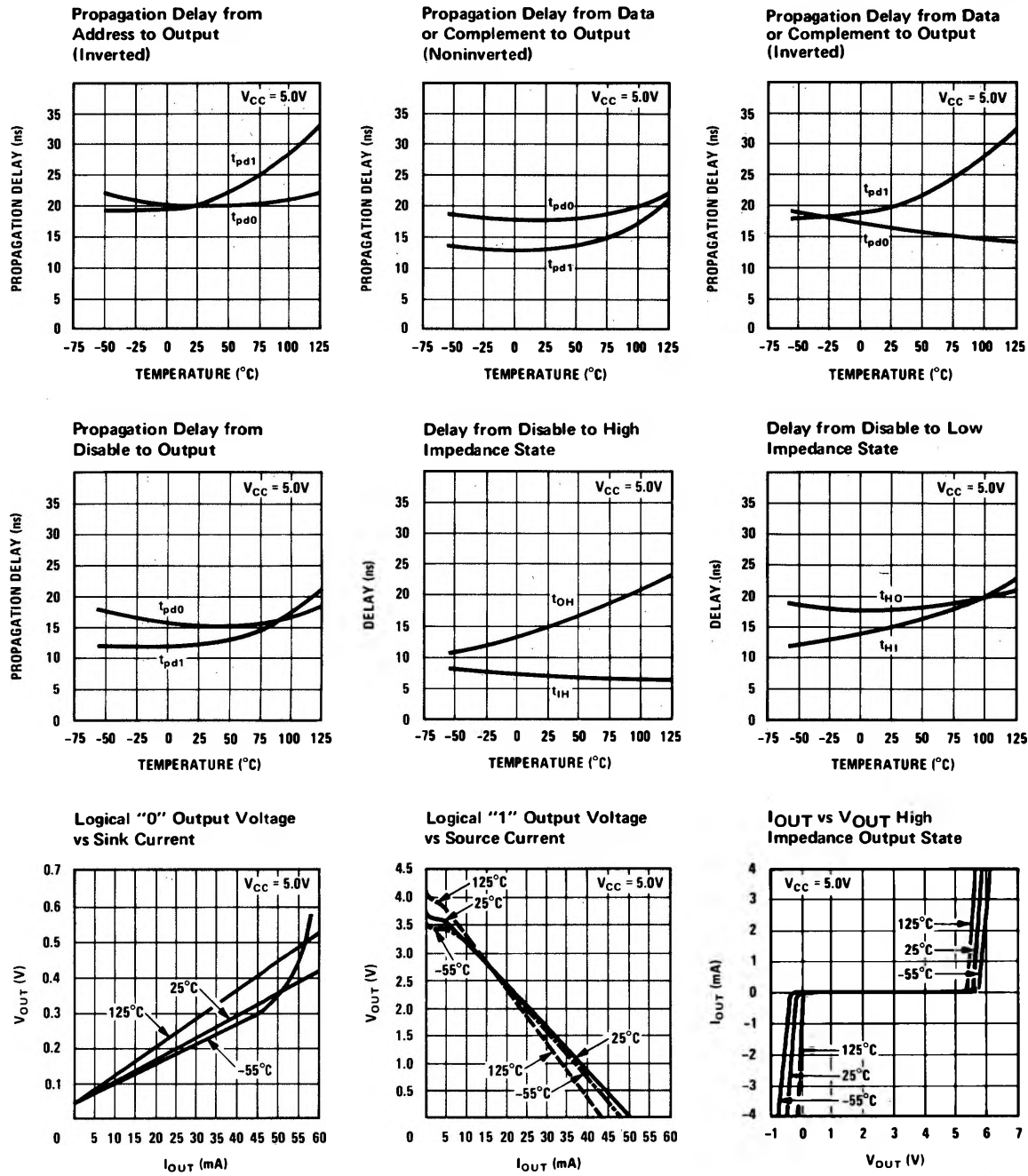

mode of operation (cont.)

normal low impedance state. All others should be gated into the high impedance state (Figure 1). The selected device therefore has the normal TTL low impedance output providing good capacitive drive capability and waveform integrity especially during the transition from the logical "0" to logical "1" state. The other outputs—in the high impedance state—take only a small amount of leakage current from the low impedance outputs. Since the logical "1" output current of the selected device is 13 times that of a conventional Series 54/74 device (5.2 mA vs 400 μ A), the output is easily able to supply that leakage current to as many as 127 other DM7230/DM8230's and still have available drive for the bus-line. (Figure 2)

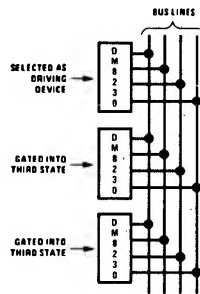

Figure 1

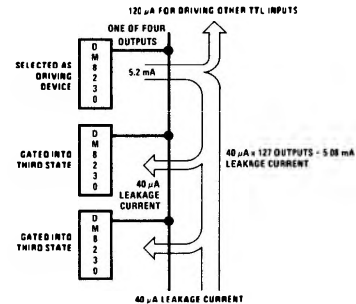
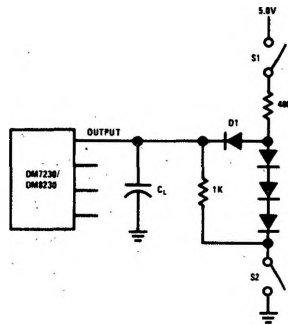

Figure 2

ac test circuit



	SWITCH S1	SWITCH S2	C _L
t _{pd1}	closed	closed	50 pF
t _{pd0}	closed	closed	50 pF
t _{OH}	closed	closed	5 pF
t _{IH}	closed	closed	5 pF
t _{HO}	closed	open	50 pF
t _{HI}	open	closed	50 pF

switching time waveforms

t_{pd1} & t_{pd0}

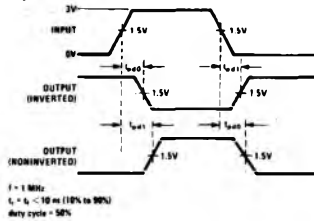

t_{OH}

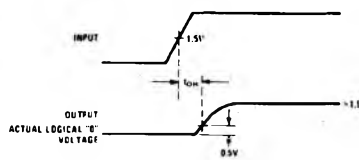

t_{IH}

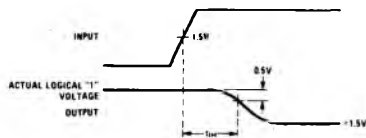

t_{HO}

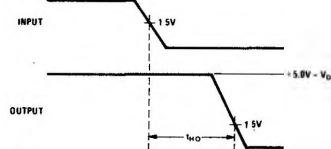

t_{HI}

