

# 54LS32,DM54LS32,DM74LS32

*54LS32 DM54LS32 DM74LS32 Quad 2-Input OR Gates*



Literature Number: SNOS303A

## 54LS32/DM54LS32/DM74LS32 Quad 2-Input OR Gates

### General Description

This device contains four independent gates each of which performs the logic OR function.

### Features

- Alternate Military/Aerospace device (54LS32) is available. Contact a National Semiconductor Sales Office/Distributor for specifications.

### Connection Diagram

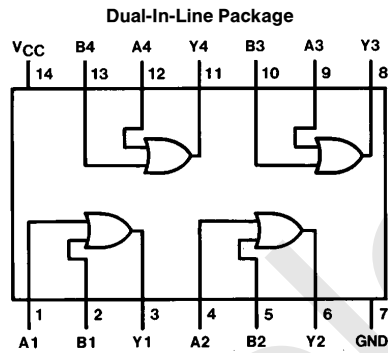

TL/F/6361-1

Order Number 54LS32DMQB, 54LS32FMQB, 54LS32LMQB,  
DM54LS32J, DM54LS32W, DM74LS32M or DM74LS32N  
See NS Package Number E20A, J14A, M14A, N14A or W14B

### Function Table

$$Y = A + B$$

| Inputs |   | Output |
|--------|---|--------|
| A      | B | Y      |
| L      | L | L      |
| L      | H | H      |
| H      | L | H      |
| H      | H | H      |

H = High Logic Level  
L = Low Logic Level

## Absolute Maximum Ratings (Note)

If Military/Aerospace specified devices are required, please contact the National Semiconductor Sales Office/Distributors for availability and specifications.

|                                      |                 |
|--------------------------------------|-----------------|
| Supply Voltage                       | 7V              |
| Input Voltage                        | 7V              |
| Operating Free Air Temperature Range |                 |
| DM54LS and 54LS                      | −55°C to +125°C |
| DM74LS                               | 0°C to +70°C    |
| Storage Temperature Range            | −65°C to +150°C |

Note: The "Absolute Maximum Ratings" are those values beyond which the safety of the device cannot be guaranteed. The device should not be operated at these limits. The parametric values defined in the "Electrical Characteristics" table are not guaranteed at the absolute maximum ratings. The "Recommended Operating Conditions" table will define the conditions for actual device operation.

## Recommended Operating Conditions

| Symbol          | Parameter                      | DM54LS32 |     |      | DM74LS32 |     |      | Units |
|-----------------|--------------------------------|----------|-----|------|----------|-----|------|-------|
|                 |                                | Min      | Nom | Max  | Min      | Nom | Max  |       |
| V <sub>CC</sub> | Supply Voltage                 | 4.5      | 5   | 5.5  | 4.75     | 5   | 5.25 | V     |
| V <sub>IH</sub> | High Level Input Voltage       | 2        |     |      | 2        |     |      | V     |
| V <sub>IL</sub> | Low Level Input Voltage        |          |     | 0.7  |          |     | 0.8  | V     |
| I <sub>OH</sub> | High Level Output Current      |          |     | −0.4 |          |     | −0.4 | mA    |
| I <sub>OL</sub> | Low Level Output Current       |          |     | 4    |          |     | 8    | mA    |
| T <sub>A</sub>  | Free Air Operating Temperature | −55      |     | 125  | 0        |     | 70   | °C    |

## Electrical Characteristics over recommended operating free air temperature range (unless otherwise noted)

| Symbol           | Parameter                         | Conditions  | Min         | Typ (Note 1) | Max   | Units |
|------------------|-----------------------------------|---|-------------|--------------|-------|-------|
| V <sub>I</sub>   | Input Clamp Voltage               | V <sub>CC</sub> = Min, I <sub>I</sub> = −18 mA                        |             |              | −1.5  | V     |
| V <sub>OH</sub>  | High Level Output Voltage         | V <sub>CC</sub> = Min, I <sub>OH</sub> = Max<br>V <sub>IH</sub> = Min | DM54<br>2.5 | 3.4          |       | V     |
| V <sub>OL</sub>  | Low Level Output Voltage          | V <sub>CC</sub> = Min, I <sub>OL</sub> = Max<br>V <sub>IL</sub> = Max | DM54        | 0.25         | 0.4   | V     |
|                  |                                   |   | DM74        | 0.35         | 0.5   |       |
|                  |                                   | I <sub>OL</sub> = 4 mA, V <sub>CC</sub> = Min                         | DM74        | 0.25         | 0.4   |       |
| I <sub>I</sub>   | Input Current @ Max Input Voltage | V <sub>CC</sub> = Max, V <sub>I</sub> = 7V                            |             |              | 0.1   | mA    |
| I <sub>IH</sub>  | High Level Input Current          | V <sub>CC</sub> = Max, V <sub>I</sub> = 2.7V                          |             |              | 20    | μA    |
| I <sub>IL</sub>  | Low Level Input Current           | V <sub>CC</sub> = Max, V <sub>I</sub> = 0.4V                          |             |              | −0.36 | mA    |
| I <sub>OS</sub>  | Short Circuit Output Current      | V <sub>CC</sub> = Max (Note 2)  | DM54        | −20          | −100  | mA    |
|                  |                                   |   | DM74        | −20          | −100  |       |
| I <sub>CCH</sub> | Supply Current with Outputs High  | V <sub>CC</sub> = Max   |             | 3.1          | 6.2   | mA    |
| I <sub>CCL</sub> | Supply Current with Outputs Low   | V <sub>CC</sub> = Max   |             | 4.9          | 9.8   | mA    |

## Switching Characteristics at V<sub>CC</sub> = 5V and T<sub>A</sub> = 25°C (See Section 1 for Test Waveforms and Output Load)

| Symbol           | Parameter                                       | R <sub>L</sub> = 2 kΩ  |     |                        |     | Units |
|------------------|---|------------------------|-----|------------------------|-----|-------|
|                  |   | C <sub>L</sub> = 15 pF |     | C <sub>L</sub> = 50 pF |     |       |
|                  |   | Min                    | Max | Min                    | Max |       |
| t <sub>PLH</sub> | Propagation Delay Time Low to High Level Output | 3                      | 11  | 4                      | 15  | ns    |
| t <sub>PHL</sub> | Propagation Delay Time High to Low Level Output | 3                      | 11  | 4                      | 15  | ns    |

Note 1: All typicals are at V<sub>CC</sub> = 5V, T<sub>A</sub> = 25°C.

Note 2: Not more than one output should be shorted at a time, and the duration should not exceed one second.

Obsolete

**Physical Dimensions** inches (millimeters)

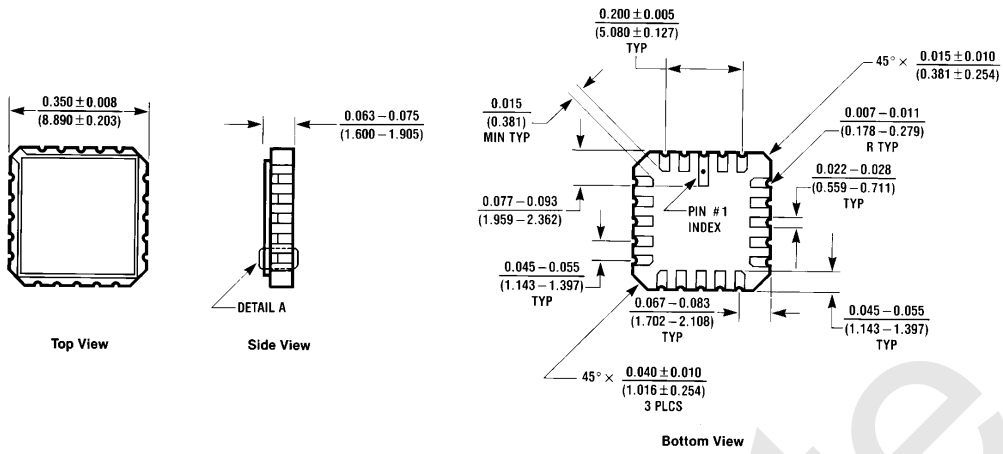

**Ceramic Leadless Chip Carrier Package (E)**  
**Order Number 54LS32LMQB**  
**NS Package Number E20A**

E20A (REV D)

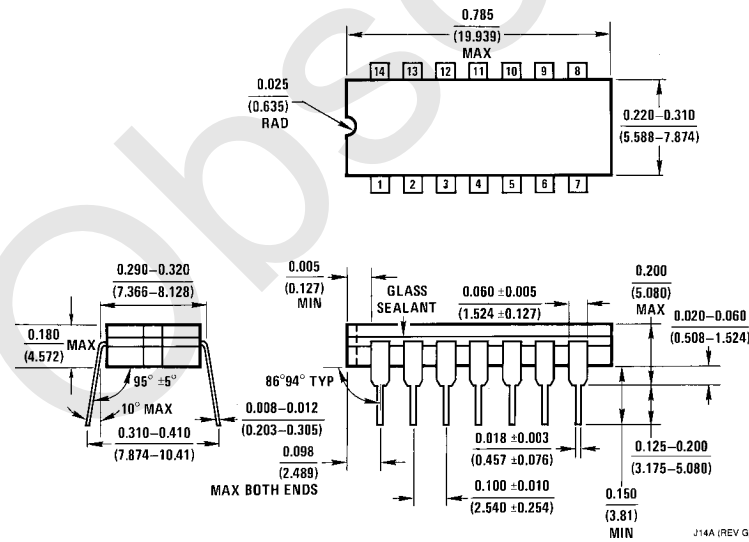

**14-Lead Ceramic Dual-In-Line Package (J)**  
**Order Number 54LS32DMQB or DM54LS32J**  
**NS Package Number J14A**

J14A (REV G)

**Physical Dimensions** inches (millimeters)

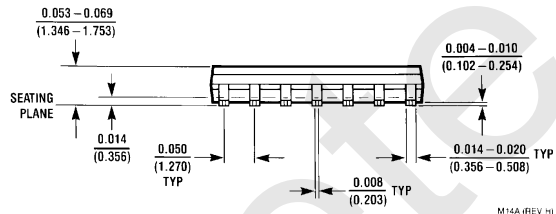
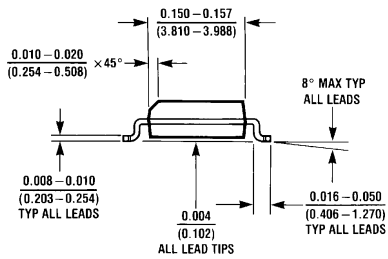
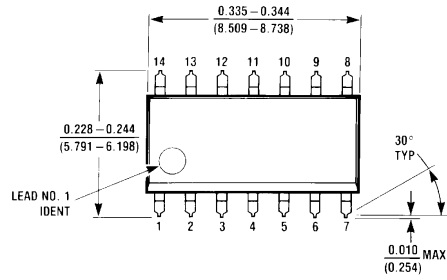

M14A (REV HI)

**14-Lead Small Outline Molded Package (M)**  
**Order Number DM74LS32M**  
**NS Package Number M14A**

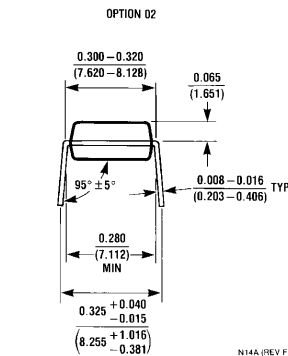
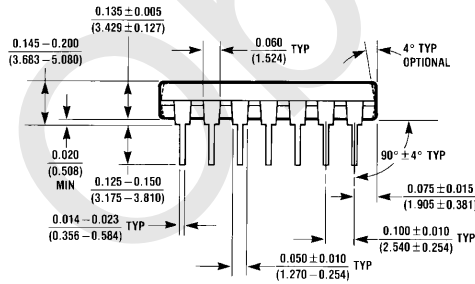
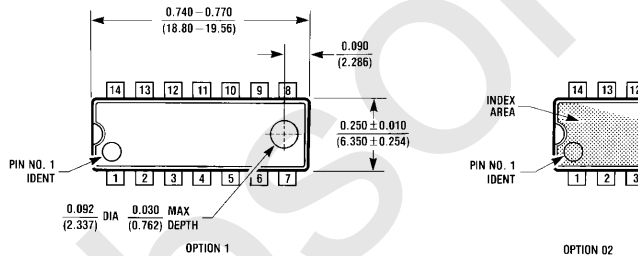

N14A (REV F)

**14-Lead Molded Dual-In-Line Package (N)**  
**Order Number DM74LS32N**  
**NS Package Number N14A**

**Physical Dimensions** inches (millimeters) (Continued)

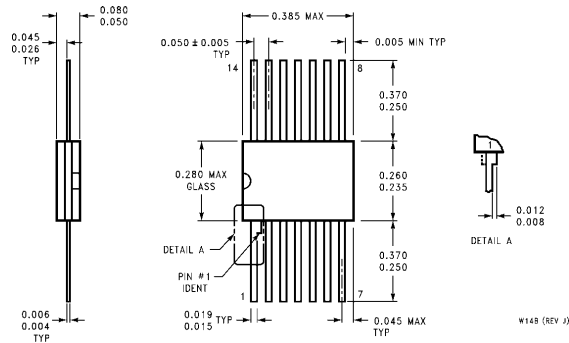

**14-Lead Ceramic Flat Package (W)**  
**Order Number 54LS32FMQB or DM54LS32W**  
**NS Package Number W14B**

**LIFE SUPPORT POLICY**

NATIONAL'S PRODUCTS ARE NOT AUTHORIZED FOR USE AS CRITICAL COMPONENTS IN LIFE SUPPORT DEVICES OR SYSTEMS WITHOUT THE EXPRESS WRITTEN APPROVAL OF THE PRESIDENT OF NATIONAL SEMICONDUCTOR CORPORATION. As used herein:

1. Life support devices or systems are devices or systems which, (a) are intended for surgical implant into the body, or (b) support or sustain life, and whose failure to perform, when properly used in accordance with instructions for use provided in the labeling, can be reasonably expected to result in a significant injury to the user.
2. A critical component is any component of a life support device or system whose failure to perform can be reasonably expected to cause the failure of the life support device or system, or to affect its safety or effectiveness.



**National Semiconductor Corporation**  
 1111 West Bardin Road  
 Arlington, TX 76017  
 Tel: 1(800) 272-9959  
 Fax: 1(800) 737-7018

**National Semiconductor Europe**  
 Fax: (+49) 0-180-530 85 86  
 Email: cnjwge@tevm2.nsc.com  
 Deutsch Tel: (+49) 0-180-530 85 85  
 English Tel: (+49) 0-180-532 78 32  
 Français Tel: (+49) 0-180-532 93 58  
 Italiano Tel: (+49) 0-180-534 16 80

**National Semiconductor Hong Kong Ltd.**  
 19th Floor, Straight Block,  
 Ocean Centre, 5 Canton Rd.  
 Tsimshatsui, Kowloon  
 Hong Kong  
 Tel: (852) 2737-1600  
 Fax: (852) 2736-9960

**National Semiconductor Japan Ltd.**  
 Tel: 81-043-299-2309  
 Fax: 81-043-299-2408

National does not assume any responsibility for use of any circuitry described, no circuit patent licenses are implied and National reserves the right at any time without notice to change said circuitry and specifications.

## IMPORTANT NOTICE

Texas Instruments Incorporated and its subsidiaries (TI) reserve the right to make corrections, modifications, enhancements, improvements, and other changes to its products and services at any time and to discontinue any product or service without notice. Customers should obtain the latest relevant information before placing orders and should verify that such information is current and complete. All products are sold subject to TI's terms and conditions of sale supplied at the time of order acknowledgment.

TI warrants performance of its hardware products to the specifications applicable at the time of sale in accordance with TI's standard warranty. Testing and other quality control techniques are used to the extent TI deems necessary to support this warranty. Except where mandated by government requirements, testing of all parameters of each product is not necessarily performed.

TI assumes no liability for applications assistance or customer product design. Customers are responsible for their products and applications using TI components. To minimize the risks associated with customer products and applications, customers should provide adequate design and operating safeguards.

TI does not warrant or represent that any license, either express or implied, is granted under any TI patent right, copyright, mask work right, or other TI intellectual property right relating to any combination, machine, or process in which TI products or services are used. Information published by TI regarding third-party products or services does not constitute a license from TI to use such products or services or a warranty or endorsement thereof. Use of such information may require a license from a third party under the patents or other intellectual property of the third party, or a license from TI under the patents or other intellectual property of TI.

Reproduction of TI information in TI data books or data sheets is permissible only if reproduction is without alteration and is accompanied by all associated warranties, conditions, limitations, and notices. Reproduction of this information with alteration is an unfair and deceptive business practice. TI is not responsible or liable for such altered documentation. Information of third parties may be subject to additional restrictions.

Resale of TI products or services with statements different from or beyond the parameters stated by TI for that product or service voids all express and any implied warranties for the associated TI product or service and is an unfair and deceptive business practice. TI is not responsible or liable for any such statements.

TI products are not authorized for use in safety-critical applications (such as life support) where a failure of the TI product would reasonably be expected to cause severe personal injury or death, unless officers of the parties have executed an agreement specifically governing such use. Buyers represent that they have all necessary expertise in the safety and regulatory ramifications of their applications, and acknowledge and agree that they are solely responsible for all legal, regulatory and safety-related requirements concerning their products and any use of TI products in such safety-critical applications, notwithstanding any applications-related information or support that may be provided by TI. Further, Buyers must fully indemnify TI and its representatives against any damages arising out of the use of TI products in such safety-critical applications.

TI products are neither designed nor intended for use in military/aerospace applications or environments unless the TI products are specifically designated by TI as military-grade or "enhanced plastic." Only products designated by TI as military-grade meet military specifications. Buyers acknowledge and agree that any such use of TI products which TI has not designated as military-grade is solely at the Buyer's risk, and that they are solely responsible for compliance with all legal and regulatory requirements in connection with such use.

TI products are neither designed nor intended for use in automotive applications or environments unless the specific TI products are designated by TI as compliant with ISO/TS 16949 requirements. Buyers acknowledge and agree that, if they use any non-designated products in automotive applications, TI will not be responsible for any failure to meet such requirements.

Following are URLs where you can obtain information on other Texas Instruments products and application solutions:

### Products

|                        |  |
|------------------------|--|
| Audio                  | <a href="http://www.ti.com/audio">www.ti.com/audio</a>                               |
| Amplifiers             | <a href="http://amplifier.ti.com">amplifier.ti.com</a>                               |
| Data Converters        | <a href="http://dataconverter.ti.com">dataconverter.ti.com</a>                       |
| DLP® Products          | <a href="http://www.dlp.com">www.dlp.com</a>   |
| DSP                    | <a href="http://dsp.ti.com">dsp.ti.com</a>   |
| Clocks and Timers      | <a href="http://www.ti.com/clocks">www.ti.com/clocks</a>                             |
| Interface              | <a href="http://interface.ti.com">interface.ti.com</a>                               |
| Logic                  | <a href="http://logic.ti.com">logic.ti.com</a>                                       |
| Power Mgmt             | <a href="http://power.ti.com">power.ti.com</a>                                       |
| Microcontrollers       | <a href="http://microcontroller.ti.com">microcontroller.ti.com</a>                   |
| RFID                   | <a href="http://www.ti-rfid.com">www.ti-rfid.com</a>                                 |
| OMAP Mobile Processors | <a href="http://www.ti.com/omap">www.ti.com/omap</a>                                 |
| Wireless Connectivity  | <a href="http://www.ti.com/wirelessconnectivity">www.ti.com/wirelessconnectivity</a> |

### Applications

|                               |  |
|-------------------------------|--|
| Communications and Telecom    | <a href="http://www.ti.com/communications">www.ti.com/communications</a>                 |
| Computers and Peripherals     | <a href="http://www.ti.com/computers">www.ti.com/computers</a>                           |
| Consumer Electronics          | <a href="http://www.ti.com/consumer-apps">www.ti.com/consumer-apps</a>                   |
| Energy and Lighting           | <a href="http://www.ti.com/energy">www.ti.com/energy</a>                                 |
| Industrial                    | <a href="http://www.ti.com/industrial">www.ti.com/industrial</a>                         |
| Medical                       | <a href="http://www.ti.com/medical">www.ti.com/medical</a>                               |
| Security                      | <a href="http://www.ti.com/security">www.ti.com/security</a>                             |
| Space, Avionics and Defense   | <a href="http://www.ti.com/space-avionics-defense">www.ti.com/space-avionics-defense</a> |
| Transportation and Automotive | <a href="http://www.ti.com/automotive">www.ti.com/automotive</a>                         |
| Video and Imaging             | <a href="http://www.ti.com/video">www.ti.com/video</a>                                   |

TI E2E Community Home Page

[e2e.ti.com](http://e2e.ti.com)

Mailing Address: Texas Instruments, Post Office Box 655303, Dallas, Texas 75265  
Copyright © 2011, Texas Instruments Incorporated