



TTL MSI

DM5490/DM7490 (SN5490/SN7490) decade counter DM5492/DM7492 (SN5492/SN7492) divide-by-twelve counter DM5493/DM7493 (SN5493/SN7493) four-bit binary counter

general description

These TTL (Transistor-Transistor-Logic) monolithic counters are capable of counting pulses at a guaranteed frequency of 20 MHz. Gating is provided to reset the counters to the more popular states. Characteristics include high speed at moderate power dissipation, high noise immunity, and minimal variation in performance over temperature. These circuits are completely compatible with other series 54/74 devices.

To provide greater flexibility, the counters may be used in any of the modes as follows:

DM5490/DM7490

1. BCD decade counter—connect the A output to the BD input. This is the normal mode of operation.
2. Symmetrical divide-by-ten operation—connect the D output to the A input. When pulses are then applied to the BD input, a symmetrical waveform one tenth of the applied frequency will appear at the A output.
3. Divide-by-five operation—if no external connections are made a frequency division of five will result between the BD input and the D output. This allows the flip flop A to be used to divide-by-two if desired.

DM5492/DM7492

1. When used as a divide-by-twelve counter output A is connected to the BC input. In this mode outputs A, C, and D provide divisions by 2, 6, and 12 respectively.
2. When the connection is not made between A and BC, and when an input frequency is applied to the BC input, a frequency division of 3 and 6 results on the C and D outputs respectively. In this mode the A flip flop may be used independently except for the common reset input.

DM5493/DM7493

1. When used as a four-bit binary counter, output A is connected to the B input. In this mode outputs A, B, C, and D provide divisions by 2, 4, 8, and 16 respectively.
2. When the connection is not made between A and B and when an input frequency is applied to the B input, a frequency division of 2, 4 and 8 results on the B, C, and D outputs respectively. In this mode the A flip flop may be used independently except for the common reset input.

logic and connection diagrams

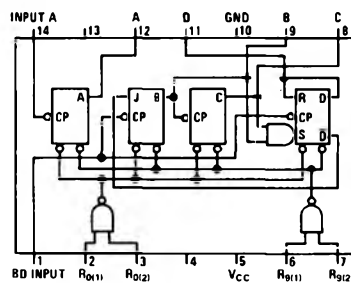

DM5490/DM7490

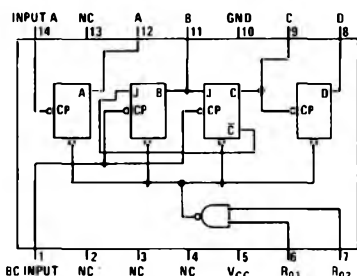

DM5492/DM7492

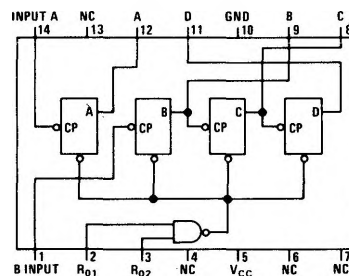

DM5493/DM7493

absolute maximum ratings

| | |
|--------------------------------------|-----------------|
| Supply Voltage | 7V |
| Input Voltage | 5.5V |
| Operating Temperature Range | |
| DM5490, DM5492, DM5493 | -55°C to +125°C |
| DM7490, DM7492, DM7493 | 0°C to +70°C |
| Storage Temperature Range | -65°C to +150°C |
| Lead Temperature (soldering, 10 sec) | 300°C |

electrical characteristics (Note 1)

| PARAMETER | CONDITIONS | MIN | TYP | MAX | UNITS |
|--|--|----------|----------------------|----------------------|----------------------|
| Input Diode Clamp Voltage | $V_{CC} = 5.0V$, $I_{OUT} = -12\text{ mA}$ $T_A = 25^\circ\text{C}$ | | -1.0 | -1.5 | mA |
| Logical "1" Input Voltage | DM5490, 92, 93 $V_{CC} = 4.5V$ DM7490, 92, 93 $V_{CC} = 4.75V$ | 2.0 | | | V |
| Logical "0" Input Voltage | DM5490, 92, 93 $V_{CC} = 4.5V$ DM7490, 92, 93 $V_{CC} = 4.75V$ | | | .8 | V |
| Logical "1" Output Voltage | DM5490, 92, 93 $V_{CC} = 4.5V$ DM7490, 92, 93 $V_{CC} = 4.75V$ $I_{OUT} = -400\ \mu\text{A}$ | 2.4 | | | V |
| Logical "0" Output Voltage | DM5490, 92, 93 $V_{CC} = 4.5V$ DM7490, 92, 93 $V_{CC} = 4.75V$ $I_{OUT} = 16\text{ mA}$ | | .2 | .4 | V |
| Logical "1" Input Current | DM5490, 92, 93 $V_{CC} = 5.5V$ DM7490, 92, 93 $V_{CC} = 5.25V$ $V_{IN} = 5.5V$ | | | 1 | mA |
| Output Short Circuit Current | DM5490, 92, 93 $V_{CC} = 5.5V$ DM7490, 92, 93 $V_{CC} = 5.25V$ (Note 2) | 20 18 | | 55 55 | mA |
| DM5490/DM7490 | | | | | |
| Logical "1" Input Current | DM5490 $V_{CC} = 5.5V$ DM7490 $V_{CC} = 5.25V$ $V_{IN} = 2.4V$ | | | | |
| $R_{O(1)}$, $R_{O(2)}$, $R_{9(1)}$, $R_{9(2)}$ | | | | 40 | μA |
| A | | | | 80 | μA |
| BD | | | | 160 | μA |
| Logical "0" Input Current | DM5490 $V_{CC} = 5.5V$ DM7490 $V_{CC} = 5.25V$ $V_{IN} = .4V$ | | | | |
| $R_{O(1)}$, $R_{O(2)}$, $R_{9(1)}$, $R_{9(2)}$ | | | | 1.6 | mA |
| A | | | | 3.2 | mA |
| BD | | | | 6.4 | mA |
| Supply Current | DM5490 $V_{CC} = 5.5V$ DM7490 $V_{CC} = 5.25V$ | | 32 | 45 | mA |
| Maximum Input Frequency | $V_{CC} = 5.0V$, $T_A = 25^\circ\text{C}$ F.O. = 10, $C_O = 50\text{ pF}$ | 20 | 32 | | MHz |
| Propagation Delay Time to a Logical "1" Level From Input to Output | F.O. = 10, $V_{CC} = 5.0V$ $C_{OUT} = 50\text{ pF}$, $T_A = 25^\circ\text{C}$ All Outputs | | 16 35 50 35 | 35 60 80 60 | ns ns ns ns |
| Propagation Delay Time to a Logical "0" Level From Input to Output | F.O. = 10, $V_{CC} = 5.0V$ $C_{OUT} = 50\text{ pF}$, $T_A = 25^\circ\text{C}$ All Outputs | | 19 35 50 35 | 35 60 80 60 | ns ns ns ns |
| Minimum Allowable Clock Pulse Width (Note 3) | $V_{CC} = 5.0V$ $T_A = 25^\circ\text{C}$ | | 8 | 15 | ns |
| DM5492/DM7492 | | | | | |
| Logical "1" Input Current | DM5492 $V_{CC} = 5.5V$ DM7492 $V_{CC} = 5.25V$ $V_{IN} = 2.4V$ | | | | |
| $R_{O(1)}$, $R_{O(2)}$ | | | | 40 | μA |
| A | | | | 80 | μA |
| BC | | | | 160 | μA |

| PARAMETER | | CONDITIONS | | MIN | TYP | MAX | UNITS |
|--|------------------|---|---------------------------------------|-----|-----|-----|---------|
| DM5492/DM7492 (Continued) | | | | | | | |
| Logical "0" Input Current | DM5492 | $V_{CC} = 5.5V$ | $V_{IN} = .4V$ | | | | |
| $R_{O(1)}, R_{O(2)}$ | DM7492 | $V_{CC} = 5.25V$ | | | | 1.6 | mA |
| A | | | | | | 3.2 | mA |
| BC | | | | | | 6.4 | mA |
| Supply Current | DM5492 | $V_{CC} = 5.5V$ | $V_{IN} (R_O) = 4.5V$ | | 30 | 43 | mA |
| | DM7492 | $V_{CC} = 5.25V$ | | | | | |
| Maximum Input Frequency | | $V_{CC} = 5.0V,$ F.O. = 10, | $T_A = 25^\circ C$ $C_O = 50 pF$ | 20 | 32 | | MHz |
| Propagation Delay Time to a Logical "1" Level From Input A to Output | A B C D | F.O. = 10, $C_{OUT} = 50 pF,$ All Outputs | $V_{CC} = 5.0V$ $T_A = 25^\circ C$ | | 16 | 35 | ns |
| | | | | | 35 | 60 | ns |
| | | | | | 35 | 60 | ns |
| | | | | | 50 | 80 | ns |
| Propagation Delay Time to a Logical "0" Level From Input A to Output | A B C D | F.O. = 10, $C_{OUT} = 50 pF,$ All Outputs | $V_{CC} = 5.0V$ $T_A = 25^\circ C$ | | 19 | 35 | ns |
| | | | | | 35 | 60 | ns |
| | | | | | 35 | 60 | ns |
| | | | | | 50 | 80 | ns |
| Minimum Allowable Clock Pulse Width (Note 3) | | $V_{CC} = 5.0V$ $T_A = 25^\circ C$ | | 8 | 15 | ns | |
| DM5493/DM7493 | | | | | | | |
| Logical "1" Input Current | DM5493 | $V_{CC} = 5.5V$ | $V_{IN} = 2.4V$ | | | | |
| $R_{O(1)}, R_{O(2)}$ | DM7493 | $V_{CC} = 5.25V$ | | | | 40 | μA |
| A, B | | | | | | 80 | μA |
| Logical "0" Input Current | DM5493 | $V_{CC} = 5.5V$ | $V_{IN} = .4V$ | | | | |
| $R_{O(1)}, R_{O(2)}$ | DM7493 | $V_{CC} = 5.25V$ | | | | 1.6 | mA |
| A, B | | | | | | 3.2 | mA |
| Supply Current | DM5493 | $V_{CC} = 5.5V$ | | | 30 | 43 | mA |
| | DM7493 | $V_{CC} = 5.25V$ | | | | | |
| Maximum Input Frequency | | $V_{CC} = 5.0V,$ F.O. = 10, | $T_A = 25^\circ C$ $C_O = 50 pF$ | 20 | 32 | | MHz |
| Propagation Delay Time to a Logical "1" Level From Input to Output | A B C D | F.O. = 10, $C_{OUT} = 50 pF,$ All Outputs | $V_{CC} = 5.0V$ $T_A = 25^\circ C$ | | 16 | 35 | ns |
| | | | | | 35 | 60 | ns |
| | | | | | 50 | 80 | ns |
| | | | | | 65 | 100 | ns |
| | | | | | | | |
| Propagation Delay Time to a Logical "0" Level From Input to Output | A B C D | F.O. = 10, $C_{OUT} = 50 pF,$ All Outputs | $V_{CC} = 5.0V$ $T_A = 25^\circ C$ | | 19 | 35 | ns |
| | | | | | 35 | 60 | ns |
| | | | | | 50 | 80 | ns |
| | | | | | 64 | 100 | ns |
| | | | | | | | |
| Minimum Allowable Clock Pulse Width (Note 3) | | $V_{CC} = 5.0V$ $T_A = 25^\circ C$ | | 8 | 15 | ns | |

Note 1: Min/max limits apply across the guaranteed operating temperature range of $-55^\circ C$ to $+125^\circ C$ for the DM5490, DM5492 and DM5493 and $0^\circ C$ to $70^\circ C$ for the DM7490, DM7492 and DM7493 unless otherwise specified. All typicals are given for $V_{CC} = 5.0V$ and $T_A = 25^\circ C$.

Note 2: Only one output may be shorted at a time.

Note 3: The flip flop will always recognize a 15 ns pulse.

ac test circuit

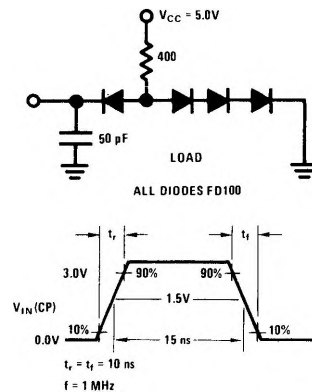
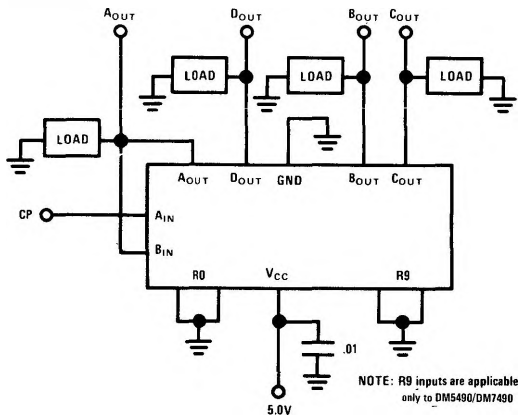

typical performance characteristics

Input Clamp Diode Characteristic

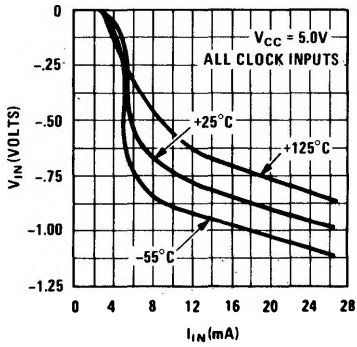

Input Clamp Diode Voltage

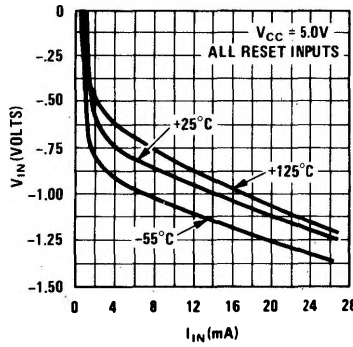

Logical "0" Output Voltage vs Sink Current

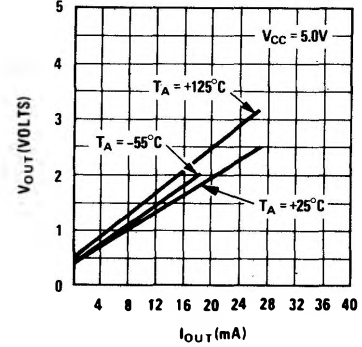

Logical "1" Output Voltage vs Source Current

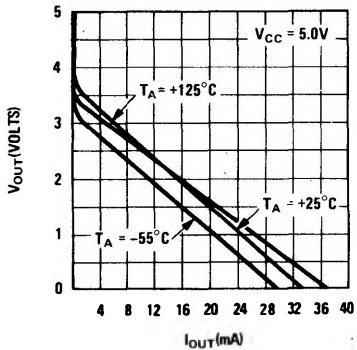

Clock Threshold vs Temperature

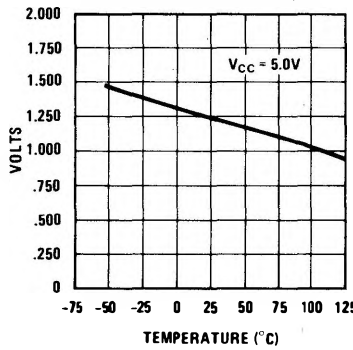

Maximum Frequency vs Temperature

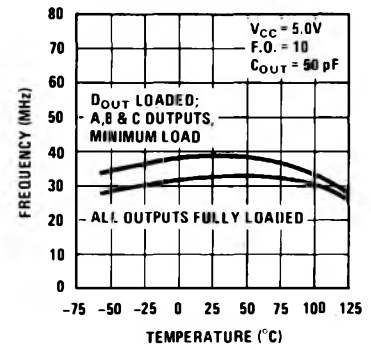

Minimum Clock Pulse Width vs Temperature

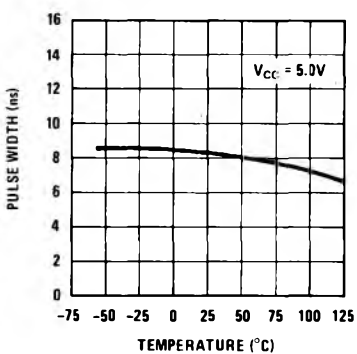

Transition Time to Output A

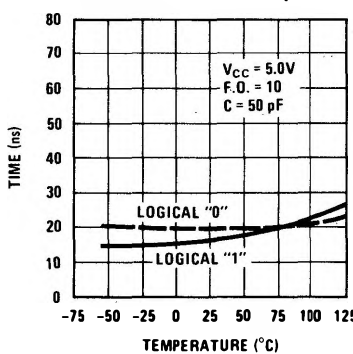

Transition Time to Outputs B, C, & D

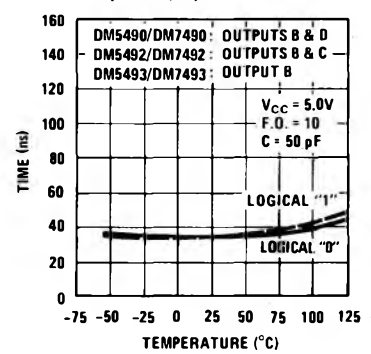

Transition Time to Outputs C & D

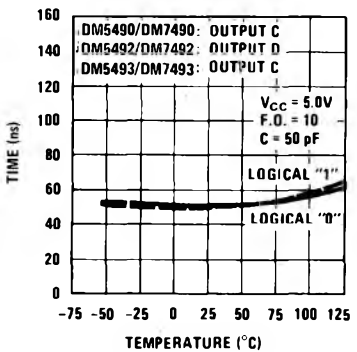

Transition Time to Output D

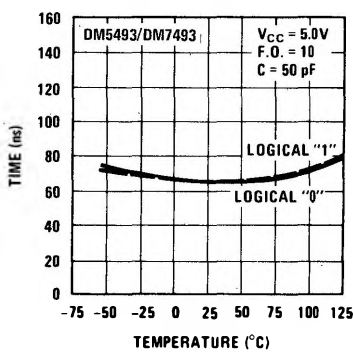

BCD count sequence

DM5490/DM7490

| COUNT | OUTPUT | | | |
|-------|--------|---|---|---|
| | D | C | B | A |
| 0 | 0 | 0 | 0 | 0 |
| 1 | 0 | 0 | 0 | 1 |
| 2 | 0 | 0 | 1 | 0 |
| 3 | 0 | 0 | 1 | 1 |
| 4 | 0 | 1 | 0 | 0 |
| 5 | 0 | 1 | 0 | 1 |
| 6 | 0 | 1 | 1 | 0 |
| 7 | 0 | 1 | 1 | 1 |
| 8 | 1 | 0 | 0 | 0 |
| 9 | 1 | 0 | 0 | 1 |

count sequence

DM5492/DM7492

| COUNT | OUTPUT | | | |
|-------|--------|---|---|---|
| | D | C | B | A |
| 0 | 0 | 0 | 0 | 0 |
| 1 | 0 | 0 | 0 | 1 |
| 2 | 0 | 0 | 1 | 0 |
| 3 | 0 | 0 | 1 | 1 |
| 4 | 0 | 1 | 0 | 0 |
| 5 | 0 | 1 | 0 | 1 |
| 6 | 1 | 0 | 0 | 0 |
| 7 | 1 | 0 | 0 | 1 |
| 8 | 1 | 0 | 1 | 0 |
| 9 | 1 | 0 | 1 | 1 |
| 10 | 1 | 1 | 0 | 0 |
| 11 | 1 | 1 | 0 | 1 |

DM5493/DM7493

| COUNT | OUTPUT | | | |
|-------|--------|---|---|---|
| | D | C | B | A |
| 0 | 0 | 0 | 0 | 0 |
| 1 | 0 | 0 | 0 | 1 |
| 2 | 0 | 0 | 1 | 0 |
| 3 | 0 | 0 | 1 | 1 |
| 4 | 0 | 1 | 0 | 0 |
| 5 | 0 | 1 | 0 | 1 |
| 6 | 0 | 1 | 1 | 0 |
| 7 | 0 | 1 | 1 | 1 |
| 8 | 1 | 0 | 0 | 0 |
| 9 | 1 | 0 | 0 | 1 |
| 10 | 1 | 0 | 1 | 0 |
| 11 | 1 | 0 | 1 | 1 |
| 12 | 1 | 1 | 0 | 0 |
| 13 | 1 | 1 | 0 | 1 |
| 14 | 1 | 1 | 1 | 0 |
| 15 | 1 | 1 | 1 | 1 |

RESET OPERATION

To reset the counter to the BCD count of zero, both Reset 0 inputs must be at logical "1" levels while at least one Reset 9 input is at a logical "0" level.

To reset the counter to the BCD count of nine, both Reset 9 inputs must be at logical "1" levels; while at least one Reset 0 input is at a logical "0".

Notes:

- Counting occurs on the negative-going edge of the input pulse.
- At least one of the Reset 0 inputs and at least one of the Reset 9 inputs must be at a logical "0" for proper counting.
- For $\div 10$ counting, connect the A output to the BD input.

RESET OPERATION

To reset the counter to the count of zero, both Reset 0 inputs must be at logical "1" levels.

Notes:

- Counting occurs on the negative-going edge of the input pulse.
- At least one of the Reset 0 inputs must be at a logical "0" for proper counting.
- For $\div 12$ counting, connect the A output to the BC input.

RESET OPERATION

To reset the counter to the count of zero, both Reset 0 inputs must be at logical "1" levels.

Notes:

- Counting occurs on the negative-going edge of the input pulse.
- At least one of the Reset 0 inputs must be at a logical "0" for proper counting.
- For $\div 16$ counting, connect the A output to the B input.