



DM7210/DM8210 eight channel digital switch DM7211/DM8211 eight channel digital switch

general description

The DM7210/DM8210 and DM7211/DM8211 are digital bipolar integrated circuits employing TTL, used to multiplex eight INPUT channels to a single OUTPUT. Depending upon the 3-bit binary number applied to the SELECT lines, the digital bit on the unique INPUT selected appears on the output.

The DM7211/DM8211 provides a strobe input which when taken to a logical "1" level places the output in the logical "1" state.

The circuit can also be used to convert parallel input information to serial output information. If

eight bits of parallel information are applied to the inputs, and if the binary numbers 000 through 111 are sequenced on the select lines, the output will provide a serial presentation of the input bits. Key features include:

- TTL Circuitry
- Input Clamping Diodes
- 1 Volt Typical Noise Immunity
- 400 mV Guaranteed Noise Immunity

The devices are completely compatible with Series 54/74 circuits.

logic table

SELECTION INPUTS			STROBE (DM7211/DM8211 ONLY)	DATA INPUTS								OUTPUT
C	B	A		0	1	2	3	4	5	6	7	
0	0	0	0	X	X	X	X	X	X	X	X	0
0	0	0	0	1	X	X	X	X	X	X	X	1
0	0	1	0	X	0	X	X	X	X	X	X	0
0	0	1	0	X	1	X	X	X	X	X	X	1
0	1	0	0	X	X	0	X	X	X	X	X	0
0	1	0	0	X	X	1	X	X	X	X	X	1
0	1	1	0	X	X	X	0	X	X	X	X	0
0	1	1	0	X	X	X	1	X	X	X	X	1
1	0	0	0	X	X	X	X	0	X	X	X	0
1	0	0	0	X	X	X	X	1	X	X	X	1
1	0	1	0	X	X	X	X	0	X	X	X	0
1	0	1	0	X	X	X	X	1	X	X	X	1
1	1	0	0	X	X	X	X	X	0	X	X	0
1	1	0	0	X	X	X	X	X	1	X	X	1
1	1	1	0	X	X	X	X	X	X	0	X	0
1	1	1	0	X	X	X	X	X	X	1	X	1
X	X	X	1	X	X	X	X	X	X	X	X	1

X = "Don't Care" Condition

connection diagrams

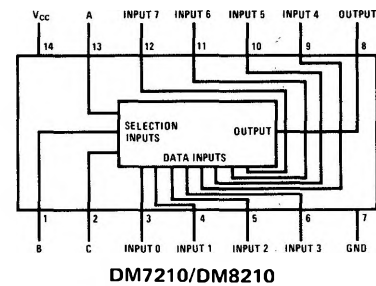

DM7210/DM8210

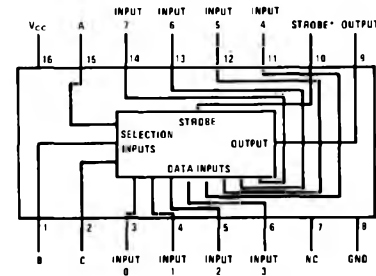

*A Logical 1 on the strobe input causes the output to go the Logical 1 state.
A Logical 0 on the strobe input allows information to be routed through the device.

DM7211/DM8211

typical application

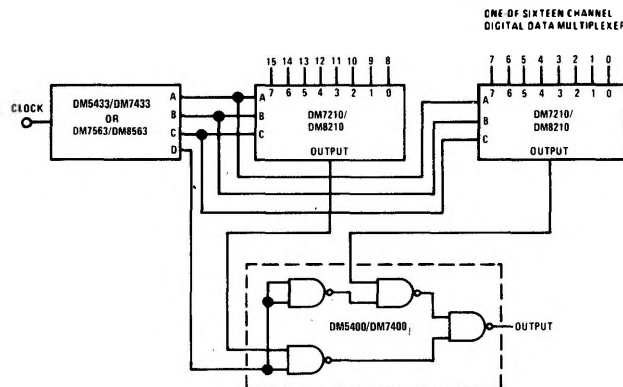

absolute maximum ratings

Supply Voltage		7V
Input Voltage		5.5V
Fanout		10
Storage Temperature Range		-65°C to +150°C
Operating Temperature Range	DM7210, DM7211	-55°C to +125°C
	DM8210, DM8211	0°C to +70°C
Lead Temperature (soldering, 10 sec)		300°C

electrical characteristics (Note 1)

PARAMETER		CONDITION	MIN	TYP	MAX	UNITS
Logical "1" Input Voltage	DM7210/DM7211	$V_{CC} = 4.5V$	2.0			V
	DM8210/DM8211	$V_{CC} = 4.75V$				
Logical "0" Input Voltage	DM7210/DM7211	$V_{CC} = 4.5V$			0.8	V
	DM8210/DM8211	$V_{CC} = 4.75V$				
Logical "1" Output Voltage	DM7210/DM7211	$V_{CC} = 4.5V$	2.4			V
	DM8210/DM8211	$V_{CC} = 4.75V$				
Logical "0" Output Voltage	DM7210/DM7211	$V_{CC} = 4.5V$			0.4	V
	DM8210/DM8211	$V_{CC} = 4.75V$				
Logical "1" Input Current (All Inputs)	DM7210/DM7211	$V_{CC} = 5.5V$			40	μA
	DM8210/DM8211	$V_{CC} = 5.25V$				
Logical "1" Input Current (All Inputs)	DM7210/DM7211	$V_{CC} = 5.5V$			1	mA
	DM8210/DM8211	$V_{CC} = 5.25V$				
Logical "0" Input Current (All Inputs)	DM7210/DM7211	$V_{CC} = 5.5V$	-1.0		-1.6	mA
	DM8210/DM8211	$V_{CC} = 5.25V$				
Input Clamp Diode (All Inputs)	DM7210/DM7211	$V_{CC} = 5.5V$	-1.0		-1.5	V
	DM8210/DM8211	$V_{CC} = 5.25V$				
Output Short Circuit Current	DM7210/DM7211	$V_{CC} = 5.5V$	-20		-55	mA
	DM8210/DM8211	$V_{CC} = 5.25V$	-18			
Power Supply Current (All Inputs GND)	DM7210/DM7211	$V_{CC} = 5.5V$		20	33	mA
	DM8210/DM8211	$V_{CC} = 5.25V$				
Propagation Delay to a Logical "0" From Data Input to Output, t_{pd0}		$V_{CC} = 5.0V, T_A = 25^\circ C$	10	21	30	ns
Propagation Delay to a Logical "0" From Strobe Input to Output		$V_{CC} = 5.0V, T_A = 25^\circ C$	10	19	27	ns
Propagation Delay to a Logical "1" From Data Input to Output, t_{pd1}		$V_{CC} = 5.0V, T_A = 25^\circ C$	10	23	32	ns
Propagation Delay to a Logical "1" From Strobe Input to Output		$V_{CC} = 5.0V, T_A = 25^\circ C$	10	21	30	ns
Data Selection Settling Time From 0→1 Transition on A, B, C (t_{s1})		$V_{CC} = 5.0V, T_A = 25^\circ C$	15	31	43	ns
Data Selection Settling Time From 1→0 Transition on A, B, C (t_{s0})		$V_{CC} = 5.0V, T_A = 25^\circ C$	15	31	42	ns

Note 1: Unless otherwise specified the min-max limits apply across the -55°C to +125°C temperature range for the DM7210 and DM7211 and across the 0°C to 70°C temperature range for the DM8210 and DM8211. Typicals are given for $V_{CC} = 5.0V$ and 25°C.

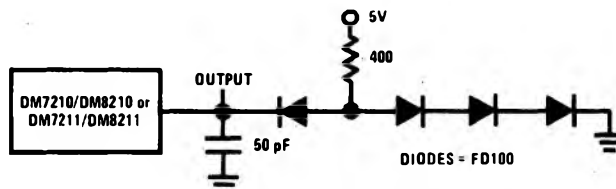
ac test circuit

typical performance characteristics

Logical "0" Output Voltage vs Sink Current

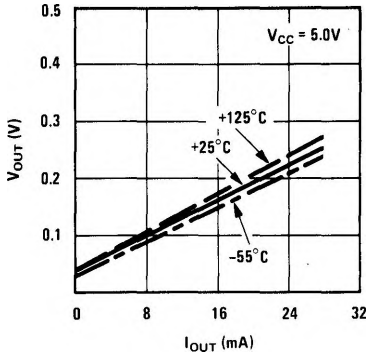

Logical "1" Output Voltage vs Source Current

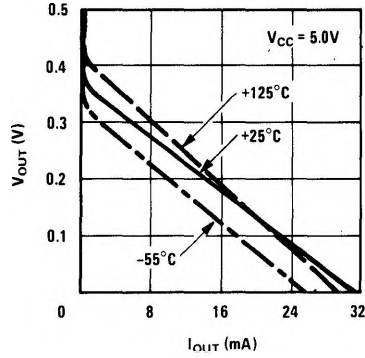

Input Clamp Diode Characteristics

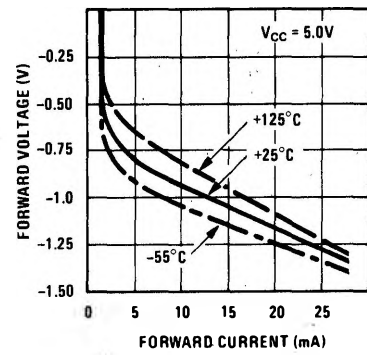

Transition Time to a Logical "1" from Strobe Input to Output, (t_{pd1}) vs Temperature - DM7211/DM8211

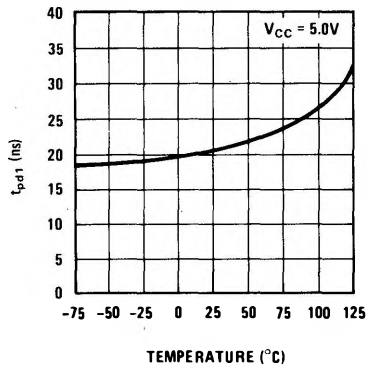

Transition Time to a Logical "0" from Strobe Input to Output, (t_{pd0}) vs Temperature - DM7211/DM8211

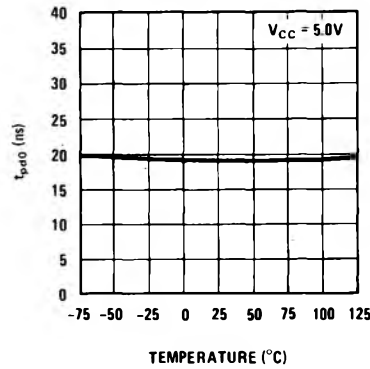

Data Selection Settling Time vs Temperature Logical "1" to Logical "1" Transition on Inputs A, B, C (t_{S1})

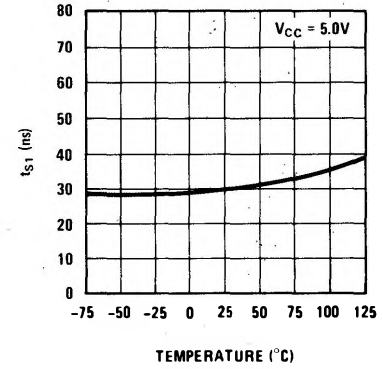

Data Selection Settling Time vs Temperature Logical "0" to Logical "1" Transition on Inputs A, B, C (t_{S0})

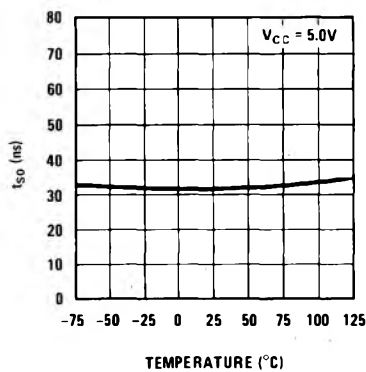

Transition Time to a Logical "1" from Data (Channel) Inputs to Output, (t_{pd1}) vs Temperature

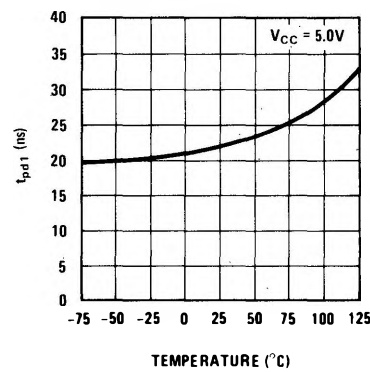

Transition Time to a Logical "0" from Data (Channel) Inputs to Output, (t_{pd0}) vs Temperature

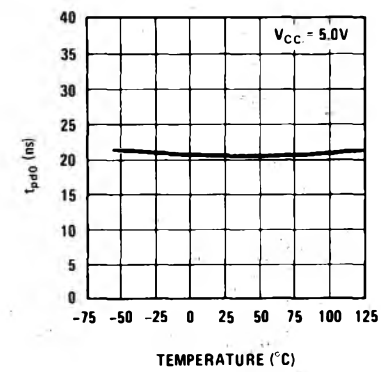

switching time waveforms

1. Propagation Delays From Data Inputs to Output

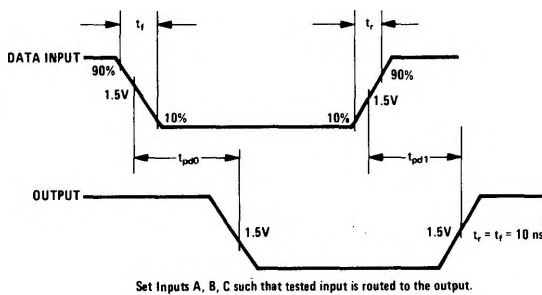

2. Settling Times From Change of A, B, or C to Correct Data Out

